

Building installations

Cable routing



Our products for your project Towards the future with OBO

Reliable, safe and of the highest quality: Product features such as installation speed, load capacity, functionality and availability are at the forefront of each of our innovations. Discover the whole range of OBO products – in a new structure, allowing us to deal in a more targeted manner with the needs of you, our customers.

It is our aim to be the first port of call for the best and most innovative connections for electrical and data technology infrastructure. Thus, when looking towards the future, we have asked ourselves what we can do to be the best possible partner you could ever imagine, also in the long term. Against this backdrop, we have optimised our structure once again, sharpened our profile and defined our services more clearly. The result: Three new areas of application, which replace our previous seven product units, in order to provide you with a contemporary and user-orientated visual identity and structure, for both products and communication. This helps you to find exactly the products you are looking for in an even faster and simpler manner.

In this catalogue, we will present the entire product variety of the Building installations application area to you. The Building installations area contains cable routing and underfloor systems for administrative and functional buildings including architectural solutions. To meet the wishes of you, our customers, as well as possible, we pay particular attention to top-class functionality during development, which also includes the highest design requirements.

This is how versatile, intelligent solutions are created, which can be used in all living spaces. Our systems transport power and data in a hidden way to the place where you need them. A large selection of device installation units and cable trunking gives you access to power, data and multimedia connections. The wide range of flexible application options thus creates an individual solution for each building.

OBO – simply better.

OBO Product Worlds



Building installations

- Electrical installation ducts and trunking
- Device installation ducts and trunking
- Skirting trunking
- Service poles
- Underfloor applications, in screed
- Underfloor applications, in concrete
- Underfloor applications, on-floor
- Service outlets for underfloor applications
- Floor sockets and floor boxes
- Installation housing and support
- Tabletop sockets
- Sockets, switches, data and multimedia technology

You can find additional products in our new Industrial and Protective installation catalogues



Industrial installations

Cable support systems and connection and fastening systems for industry and construction project infrastructure

- Cable trays
- Mesh cable trays
- Cable ladders
- Industrial ducts
- Support structures
- Electrical installation pipes
- Wiring ducts
- Power supply units
- Distributors
- Junction boxes
- Concealed and cavity wall installations
- Terminals
- Cable glands
- Installation and fastening clips
- Anchors and fastening systems



Safety and protection installations

Lightning, surge and fire protection systems

- Surge protection
- Explosion protection
- Lightning protection
- Earthing
- Equipotential bonding
- Insulation
- Cable bandages – prevention of the spread of fire
- Escape route installations – false ceiling mounting
- Fire protection ducts
- Systems for the maintenance of electrical functionality – cable-specific routing variants
- Systems for the maintenance of electrical functionality – standard support structures and routing systems
- Systems for the maintenance of electrical functionality – FireBox T series junction boxes
- Anchoring systems

Contents

A large, modern architectural atrium with a glass and steel ceiling, concrete pillars, and a red wall in the background. The space is open and bright, with a polished floor and a glass railing in the foreground.

Electrical installation ducts and trunking

Page 10



Device installation ducts and trunking

Page 122



Skirting trunking

Page 246



Service poles

Page 250

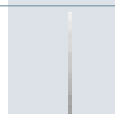

Connectable connection technology, Wieland GST18, WAGO WINSTA

Page 282



Sockets, switches, data and multimedia technology

Page 296



Directories

Page 334



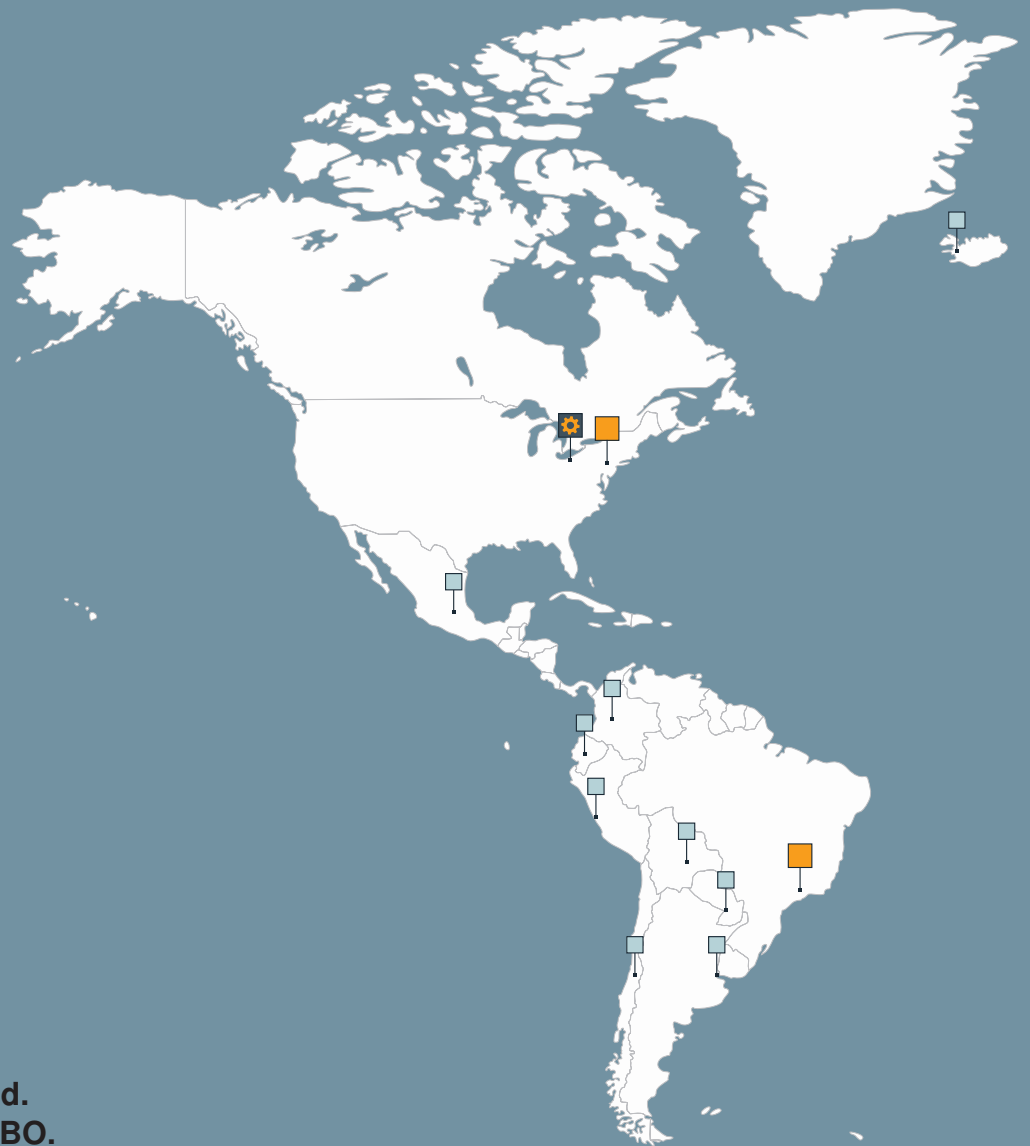

**Welcome world.
Welcome to OBO.**

New solutions to improve functionality and the ease of installation – OBO employees all around the world use their abilities and creativity to make this happen. Because we know that each individual market has its special characteristics and that the requirements for our products change within each market, we have paid particular attention to the compatibility of products in their place of use. We always offer our customers intelligent, well-thought-out solutions. Our brands always keep this promise. The OBO global team wishes to make the work of electrical planners and operatives around the world as easy as possible.

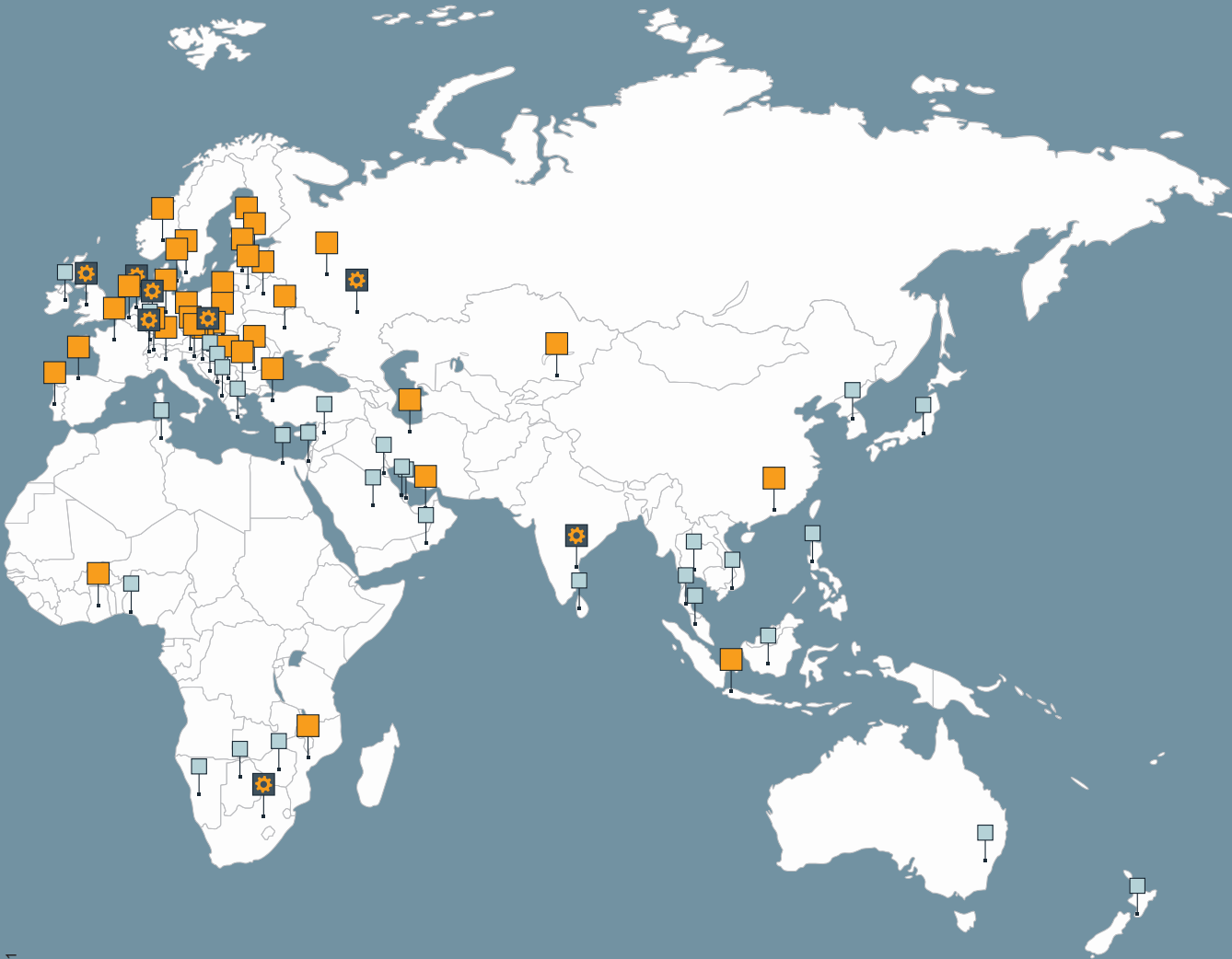

Production location



Subsidiary



Representative office

OBO Support & *contact*

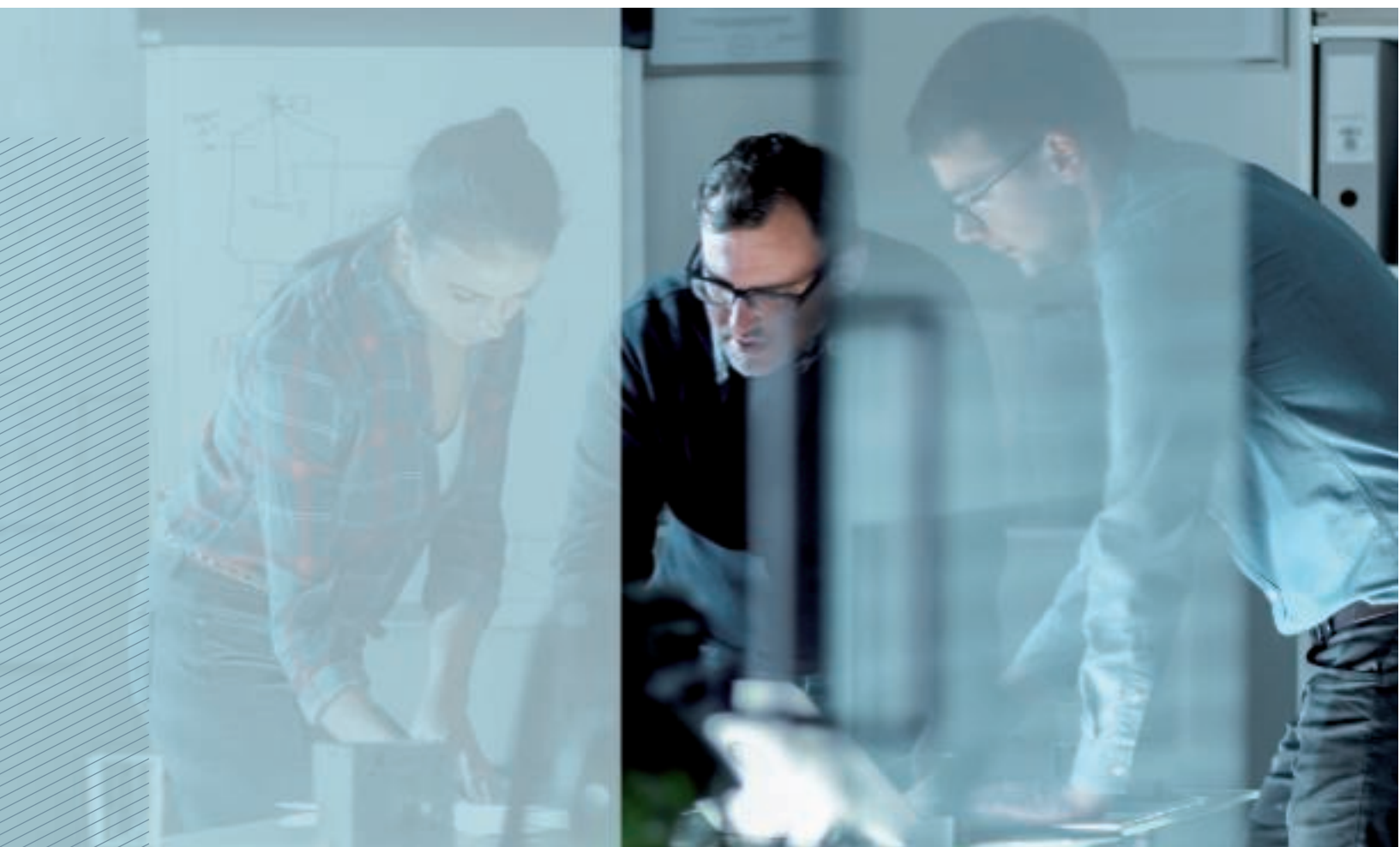

***You have a
problem?
We have the
solution!***

OBO Bettermann is more than the sum of its products. In any situation, we are the reliable partner right by your side. You have a problem? We have the solution!

It doesn't matter in which area of industry our support is needed – from industrial and plant engineering to private, public and administrative buildings, as well as in the areas of mobility and renewable energies – we have everything that you need.

OBO can not only provide the entire electro-technical infrastructure with the best possible products. We can also support you with sound expert knowledge and more than 100 years of experience, right from the planning phase through to the realisation of your projects. OBO – solutions you can rely on.

What is OBO Support?

Every OBO product carries a plus inside it, which only a branded product can offer. It is developed, manufactured and tested with a high level of competence, from the idea right through to the final check. In addition, our specialists are available for consultation and can offer you assistance and training courses for products at any time.

Together with you, we plan your project and help you choose the right products, and are also available to you at any time should you need us. From flawless logistics through to practical information – we can provide support at every level. We can also offer security through certificates on the conformity of our products with the most important standards and directives.

We are as flexible as you are – because we know how practical people work and what is important to them. Each step is a plus – that is the OBO Support concept.

You can contact our Customer Service department on:

Monday to Friday
08:00 a.m. to 5:00 p.m.

Estonia: +372 6519870

Latvia: +371 67802050

Lithuania: +370 52375911

Estonia: obo@obo.ee

Latvia: obo@obo.lv

Lithuania: obo@obo.lt



Service



Training



Handling



Certification

Service – OBO can help

Everywhere and in every project phase:

- Highly competent hotline
- Product and system information, digitally or printed
- Selection and planning aids on the web, as an app, as a CAD application or in printed form
- 2D and 3D product data for planning
- Field service, branch offices and subsidiaries in 60 countries
- Engineering services for major projects

Training courses from OBO

- Seminars and workshops
- Local consultation and training courses
- Planner days

Handling – OBO delivers reliably

With optimised delivery processes:

- Reliable logistics
- Practical transport systems and packaging
- Loading gear handling and disposal concepts

Certification and guarantee



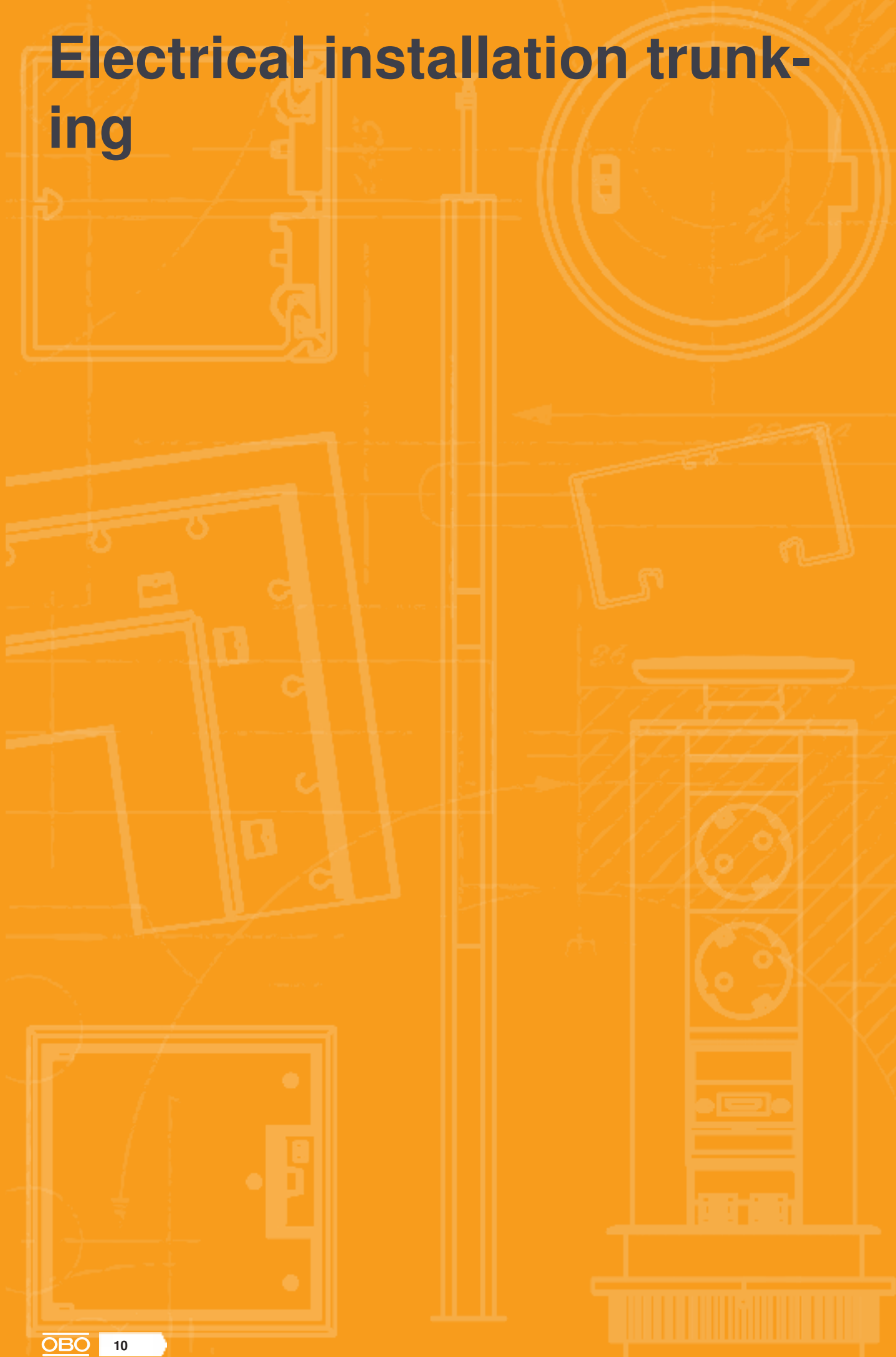

OBO offers safety. Our products fulfil the most important country-specific regulations:

- Conformity (e.g. IEC, VDE, CE, KEMA, KEUR, UL)
- Certification (e.g. DIN EN, DGNB)
- 5-year guarantee for surge protection products
- Guarantee management

Electrical installation trunking



Electrical installation trunking

	Cable trunking	14
	Cable trunking, halogen-free	66
	Metal cable trunking	82
	Accessories, cable trunking	120

Mini ducts with hinged lid

Mini trunking with adhesive film and hinged cover MD4

PVC

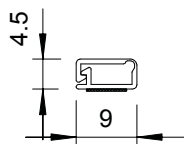

Type	Colour	Length mm	Pack m	Weight kg/100 m	Item no.
WDKMD4RW	Pure white	2000	224	3.300	6150268

Mini trunking with adhesive film and hinged cover.

Mini trunking with adhesive film and hinged cover MD7

PVC

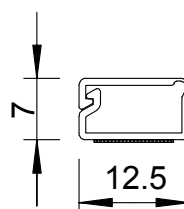

Type	Colour	Length mm	Pack m	Weight kg/100 m	Item no.
WDKMD7RW	Pure white	2000	100	5.000	6150276

Mini trunking with adhesived film and hinge cover.

Mini trunking with adhesive film and hinged cover MD12

PVC

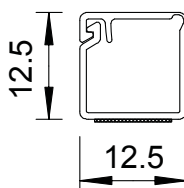

Type	Colour	Length mm	Pack m	Weight kg/100 m	Item no.
WDKMD12RW	Pure white	2000	80	7.000	6150284

Mini trunking with adhesive film and hinged cover.

PVC

Mini trunking with adhesive film and hinged cover MD17

Type	Colour	Length mm	Pack m	Weight kg/100 m	Item no.
WDKMD17RW	Pure white	2000	56	9.000	6150292

Mini trunking with adhesive film and hinged cover.

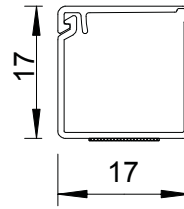

PVC

Mini trunking with adhesive film and hinge cover MD12

Type	Colour	Length mm	Pack m	Weight kg/100 m	Item no.
WDKMD12CW	Cream	2000	80	7.000	6150179

Mini trunking with adhesive film and hinged cover.

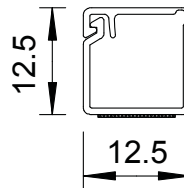

PVC

Mini trunking with adhesive film and hinge cover MD17

Type	Colour	Length mm	Pack m	Weight kg/100 m	Item no.
WDKMD17CW	Cream	2000	56	9.000	6150187

Mini trunking with adhesive film and hinged cover.

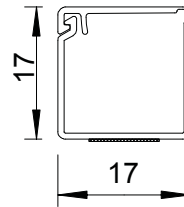

WDK cable trunking

Installation principle



1	Trunking	WDK
2	Joint cover	WDK HS
3	Internal corner cover	
4	External corner cover	WDK HI
5	T- and crosspiece cover	WDK HT
6	Flat angle cover	WDK HF
7	End piece	WDK HE
8	Partition	WWDK HT
9	Service outlet	71 GD6
10	Cover for single accessory mounting box	WDK HO

PVC

Trunking, type WDK 10020

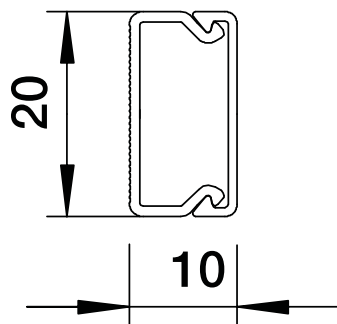

Trunking cover and base with base perforation.

Type	Colour	Length mm	Pack m	Weight kg/100 m	Item no.
WDK10020RW	Pure white	2000	96	10.000	6150764
WDK10020SW	Jet black	2000	96	10.000	6027321

PVC

Joint cover, trunking type WDK 10020

Type	Colour	Dim. mm	Dim. b mm	Pack Piece	Weight kg/100 pc.	Item no.
WDK HS10020RW	Pure white	22	14	10	0.090	6154026

Joint cover for smooth connection of trunking segments.

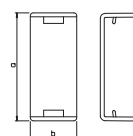

PVC

Internal corner cover, trunking type WDK 10020

Type	Colour	Dim. mm	Pack Piece	Weight kg/100 pc.	Item no.
WDK HI10020RW	Pure white	30	4	0.285	6154328

Internal corner cover for changing the direction of the WDK trunking.

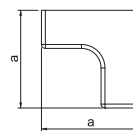

PVC

External corner cover, trunking type WDK 10020

Type	Colour	Dim. mm	Pack Piece	Weight kg/100 pc.	Item no.
WDK HA10020RW	Pure white	30	4	0.344	6154417

External corner cover for changing the direction of the WDK trunking.

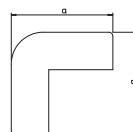

Trunking height 10 mm, trunking width 20 mm

Flat angle cover, trunking type WDK 10020

PVC

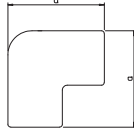

Type	Colour	Dim. mm	Pack Piece	Weight kg/100 pc.	Item no.
WDK HF10020RW	Pure white	40	4	0.365	6154212

Flat angle hood for changing the direction of the WDK trunking.

End piece, trunking type WDK 10020

PVC

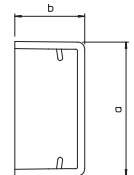

Type	Colour	Dim. mm	Dim. b mm	Pack Piece	Weight kg/100 pc.	Item no.
WDK HE10020RW	Pure white	22	11	10	0.106	6154514

End piece for closing the WDK trunking.

Duct height 10 mm, duct width 20 mm

T piece cover, for trunking type WDK 10020

PVC

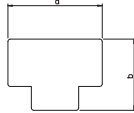

Type	Colour	Dim. mm	Pack Piece	Weight kg/100 pc.	Item no.
WDK HT10020RW	Pure white	45	4	0.334	6154115

T piece hood for changing the direction of the WDK trunking.

PVC

Trunking, type WDK 10030

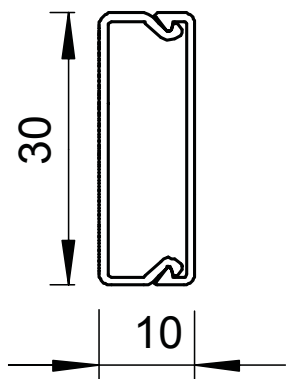

Trunking cover and base with base perforation.

Type	Colour	Length mm	Pack m	Weight kg/100 m	Item no.
WDK10030RW	Pure white	2000	64	13.000	6150780

PVC

Joint cover, for trunking, type WDK 10030

Type	Colour	Dim. mm	Dim. b mm	Pack Piece	Weight kg/100 pc.	Item no.
WDK HS10030RW	Pure white	32	14	10	0.115	6154034

Joint cover for smooth connection of trunking segments.

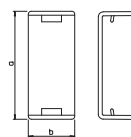

PVC

Internal corner cover, Trunking type WDK 10030

Type	Colour	Dim. mm	Pack Piece	Weight kg/100 pc.	Item no.
WDK HI10030RW	Pure white	30	4	0.330	6154336

Internal corner cover for changing the direction of the WDK trunking.

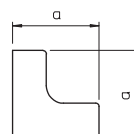

PVC

External corner cover, Trunking type WDK 10030

Type	Colour	Dim. mm	Pack Piece	Weight kg/100 pc.	Item no.
WDK HA10030RW	Pure white	30	4	0.450	6154425

External corner cover for changing the direction of the WDK trunking.

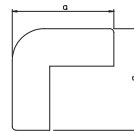

Trunking height 10 mm, trunking width 30 mm

Flat angle cover, Trunking type WDK 10030

PVC

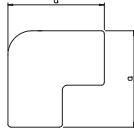

Type	Colour	Dim. mm	Pack Piece	Weight kg/100 pc.	Item no.
WDK HF10030RW	Pure white	50	4	0.555	6154220

Flat angle hood for changing the direction of the WDK trunking.

T piece cover, for trunking type WDK 10030

PVC

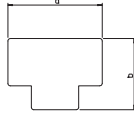

Type	Colour	Dim. mm	Dim. b mm	Pack Piece	Weight kg/100 pc.	Item no.
WDK HT10030RW	Pure white	55	44	4	0.455	6154123

T piece cover for changing the direction of the WDK trunking.

End piece, trunking type WDK 10030

PVC

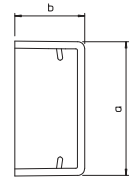

Type	Colour	Dim. mm	Dim. b mm	Pack Piece	Weight kg/100 pc.	Item no.
WDK HE10030RW	Pure white	32	11	10	0.139	6154522

End piece to close the WDK trunking.

PVC

Trunking, type WDK 15015

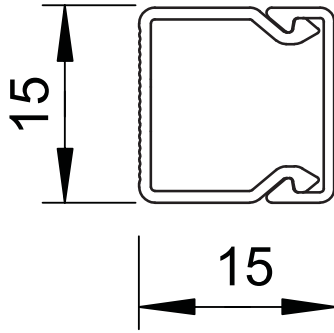

Trunking cover and base with base perforation.

Type	Colour	Length mm	Pack m	Weight kg/100 m	Item no.
WDK15015RW	Pure white	2000	56	9.000	6191002
WDK15015LGR	Light grey	2000	56	9.000	6024947
WDK15015GR	Stone grey	2000	56	9.000	6024955
WDK15015BR	Sepia brown	2000	56	9.000	6024971
WDK15015SW	Jet black	2000	56	9.000	6024949

PVC

End piece, trunking type WDK 15015

Type	Colour	Dim. mm	Dim. b mm	Pack Piece	Weight kg/100 pc.	Item no.
WDK HE15015RW	Pure white	15	15	10	0.082	6193099
WDK HE15015LGR	Light grey	15	15	10	0.081	6183603
WDK HE15015GR	Stone grey	15	15	10	0.081	6158692

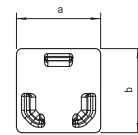

End piece to close the WDK trunking.

Trunking height 15 mm, trunking width 30 mm

Trunking, type WDK 15030

PVC

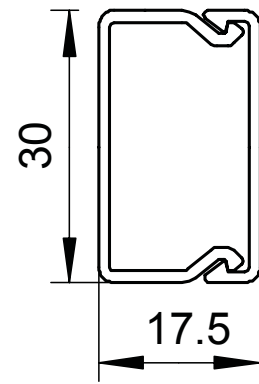
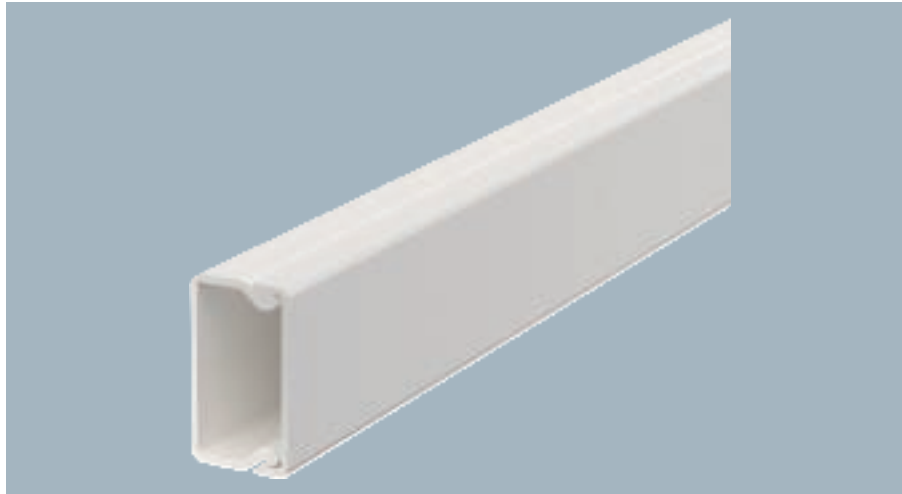

Type	Colour	Length mm	Pack m	Weight kg/100 m	Item no.
WDK15030RW	Pure white	2000	32	19.500	6191010
WDK15030GR	Stone grey	2000	32	19.500	6025005
WDK15030BR	Sepia brown	2000	32	19.500	6025021
WDK15030LGR	Light grey	2000	32	19.500	6025048

Trunking cover and base with base perforation.

Joint cover, for trunking, type WDK 15030

PVC

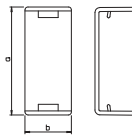

Type	Colour	Dim. mm	Dim. b mm	Pack Piece	Weight kg/100 pc.	Item no.
WDK HS15030RW	Pure white	32	14	10	0.136	6193501
WDK HS15030GR	Stone grey	32	14	10	0.136	6158838

Joint cover for smooth connection of trunking segments.

Internal corner cover, trunking type WDK 15030

PVC

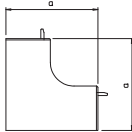

Type	Colour	Dim. mm	Pack Piece	Weight kg/100 pc.	Item no.
WDK HI15030RW	Pure white	38.5	4	0.789	6191843
WDK HI15030GR	Stone grey	38.5	4	0.790	6158234

Internal corner cover for changing the direction of the WDK trunking.

External corner cover, trunking type WDK 15030

PVC

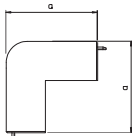

Type	Colour	Dim. mm	Pack Piece	Weight kg/100 pc.	Item no.
WDK HA15030RW	Pure white	38.5	4	1.114	6192149
WDK HA15030GR	Stone grey	38.5	4	1.114	6158358

External corner cover for changing the direction of the WDK trunking.

PVC

Flat angle cover, trunking type WDK 15030

Type	Colour	Dim. mm	Pack Piece	Weight kg/100 pc.	Item no.
WDK HF15030RW	Pure white	53	4	0.965	6192750
WDK HF15030GR	Stone grey	53	4	0.965	6158595

Flat angle hood for changing the direction of the WDK trunking.

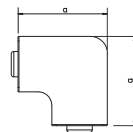

PVC

T piece cover, for trunking type WDK 15030

Type	Colour	Dim. mm	Dim. b mm	Pack Piece	Weight kg/100 pc.	Item no.
WDK HT15030RW	Pure white	73	53	4	1.119	6192459
WDK HT15030GR	Stone grey	73	53	4	1.119	6158463

T piece cover for changing the direction of the WDK trunking.

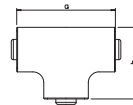

PVC

End piece, trunking type WDK 15030

Type	Colour	Dim. mm	Dim. b mm	Pack Piece	Weight kg/100 pc.	Item no.
WDK HE15030RW	Pure white	30	17	10	0.230	6193102
WDK HE15030GR	Stone grey	30	17	10	0.230	6158714

End piece to close the WDK trunking.

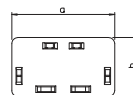

Trunking height 15 mm, trunking width 40 mm

Trunking, type WDK 15040

PVC

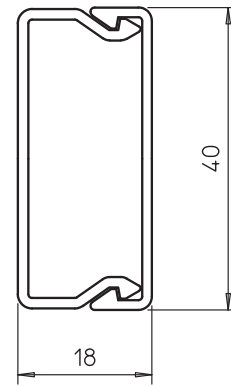
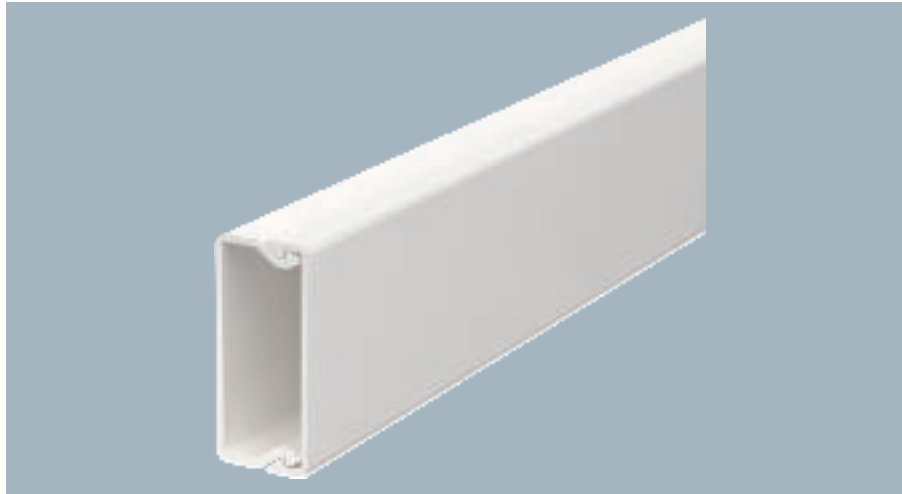

Type	Colour	Length mm	Pack m	Weight kg/100 m	Item no.
WDK15040RW	Pure white	2000	36	23.000	6191029
WDK15040GR	Stone grey	2000	36	23.000	6025137

Trunking cover and base with base perforation.

Joint cover, for trunking, type WDK 15040

PVC

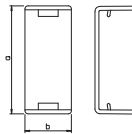

Type	Colour	Dim. mm	Dim. b mm	Pack Piece	Weight kg/100 pc.	Item no.
WDK HS15040RW	Pure white	42	14	10	0.190	6193528
WDK HS15040GR	Stone grey	42	14	10	0.190	6158846

Joint cover for smooth connection of trunking segments.

Internal corner hood, for trunking type WDK 15040

PVC

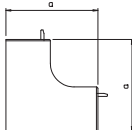

Type	Colour	Dim. mm	Pack Piece	Weight kg/100 pc.	Item no.
WDK HI15040RW	Pure white	42	4	1.070	6191851
WDK HI15040GR	Stone grey	42	4	1.064	6158242

Internal corner cover for changing the direction of the WDK trunking.

External corner cover, for trunking type WDK 15040

PVC

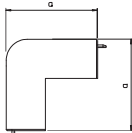

Type	Colour	Dim. mm	Pack Piece	Weight kg/100 pc.	Item no.
WDK HA15040RW	Pure white	42	4	1.429	6192157
WDK HA15040GR	Stone grey	42	4	1.400	6158366

External corner hood for changing the direction of the WDK trunking.

PVC

Flat angle cover, for trunking type WDK 15040

Type	Colour	Dim. mm	Pack Piece	Weight kg/100 pc.	Item no.
WDK HF15040RW	Pure white	63	4	1.471	6192769
WDK HF15040GR	Stone grey	63	4	1.500	6158609

Flat angle hood for changing the direction of the WDK trunking.

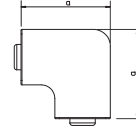

PVC

T piece cover, for trunking type WDK 15040

Type	Colour	Dim. mm	Dim. b mm	Pack Piece	Weight kg/100 pc.	Item no.
WDK HT15040RW	Pure white	83	74	4	1.746	6192467
WDK HT15040GR	Stone grey	83	74	4	1.746	6158471

T piece cover for changing the direction of the WDK trunking.

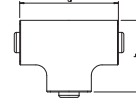

PVC

End piece, trunking type WDK 15040

Type	Colour	Dim. mm	Dim. b mm	Pack Piece	Weight kg/100 pc.	Item no.
WDK HE15040RW	Pure white	40	17	10	0.299	6193110
WDK HE15040GR	Stone grey	40	17	10	0.299	6158722

End piece to close the WDK trunking.

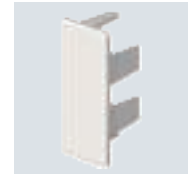
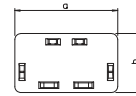

Trunking height 20 mm, trunking width 20 mm

Trunking, type WDK 20020 with base perforation

PVC

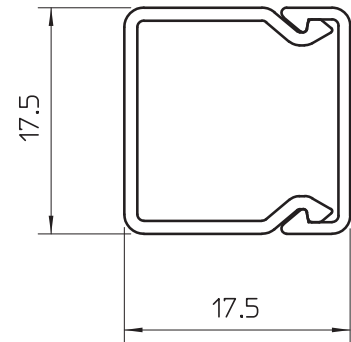
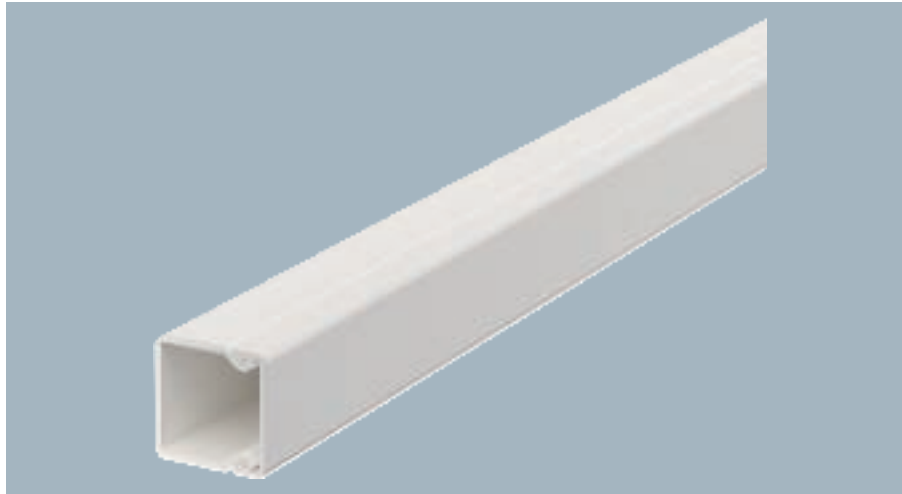

Type	Colour	Length mm	Pack m	Weight kg/100 m	Item no.
WDK20020RW	Pure white	2000	48	11.100	6191037
WDK20020LGR	Light grey	2000	48	11.100	6025102
WDK20020GR	Stone grey	2000	48	11.100	6025110
WDK20020BR	Sepia brown	2000	48	11.100	6025129
WDK20020SW	Jet black	2000	48	11.000	6025155

Trunking cover and base with base perforation.

Internal corner cover, trunking type WDK 20020

PVC

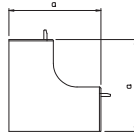
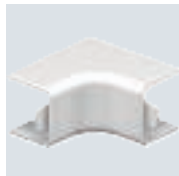

Type	Colour	Dim. mm	Pack Piece	Weight kg/100 pc.	Item no.
WDK HI20020RW	Pure white	38.5	4	0.619	6191878
WDK HI20020LGR	Light grey	38.5	4	0.623	6182011
WDK HI20020GR	Stone grey	38.5	4	0.623	6158226

Internal corner cover for changing the direction of the WDK trunking.

External corner cover, trunking type WDK 20020

PVC

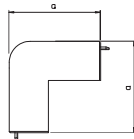

Type	Colour	Dim. mm	Pack Piece	Weight kg/100 pc.	Item no.
WDK HA20020RW	Pure white	38.5	4	0.678	6192165
WDK HA20020LGR	Light grey	38.5	4	0.678	6182402
WDK HA20020GR	Stone grey	38.5	4	0.678	6158331

External corner cover for changing the direction of the WDK trunking.

Flat angle cover, trunking type WDK 20020

PVC

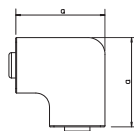

Type	Colour	Dim. mm	Pack Piece	Weight kg/100 pc.	Item no.
WDK HF20020RW	Pure white	38	4	0.588	6192777
WDK HF20020LGR	Light grey	38	4	0.596	6183212
WDK HF20020GR	Stone grey	38	4	0.596	6158587

Flat angle cover for changing the direction of the WDK trunking.

PVC

T piece cover, for trunking type WDK 20020

Type	Colour	Dim.		Pack Piece	Weight kg/100 pc.	Item no.
		mm	mm			
WDK HT20020RW	Pure white	57	39	4	0.751	6192475
WDK HT20020LGR	Light grey	57	39	4	0.751	6182801
WDK HT20020GR	Stone grey	57	39	4	0.751	6158455

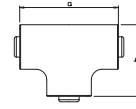

T piece cover for changing the direction of the WDK trunking.

PVC

End piece, Trunking type WDK 20020

Type	Colour	Dim.		Pack Piece	Weight kg/100 pc.	Item no.
		mm	mm			
WDK HE20020RW	Pure white	17	17	10	0.103	6193129
WDK HE20020LGR	Light grey	17	17	10	0.101	6183611
WDK HE20020GR	Stone grey	17	17	10	0.101	6158706

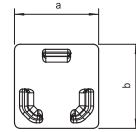

End piece to close the WDK trunking.

Trunking height 20 mm, trunking width 35 mm

Trunking, type WDK 20035

PVC

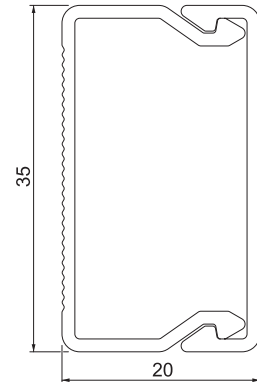

Type	Colour	Length mm	Pack m	Weight kg/100 m	Item no.
WDK20035RW	Pure white	2000	32	23.900	6191045
WDK20035LGR	Light grey	2000	32	23.900	6026354
WDK20035GR	Stone grey	2000	32	23.900	6026362

Trunking cover and base with base perforation.

End piece, trunking type WDK 20035

PVC

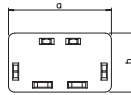

Type	Colour	Dim. mm	Dim. b mm	Pack Piece	Weight kg/100 pc.	Item no.
WDK HE20035RW	Pure white	35	20	10	0.334	6193137
WDK HE20035LGR	Light grey	35	20	10	0.334	6183654
WDK HE20035GR	Stone grey	35	20	10	0.334	6158781

End piece to close the WDK trunking.

PVC

Trunking, type WDK 20050

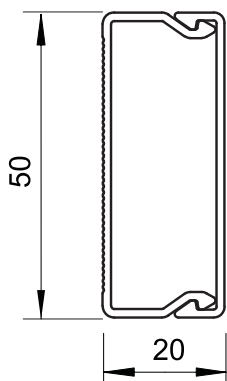

Trunking cover and base with base perforation.

Type	Colour	Length mm	Pack m	Weight kg/100 m	Item no.
WDK20050RW	Pure white	2000	42	30.700	6168736

PVC

Trunking, type WDK-N 20050

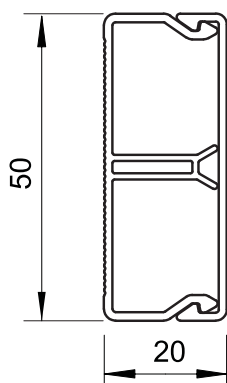

Trunking cover and base with base perforation.

Type	Colour	Length mm	Pack m	Weight kg/100 m	Item no.
WDK-N20050RW	Pure white	2000	42	37.000	6168744

PVC

Joint cover, for trunking, type WDK 20050

Type	Colour	Dim. mm	Dim. b mm	Pack Piece	Weight kg/100 pc.	Item no.
WDK HS20050RW	Pure white	53	14	10	0.267	6154069

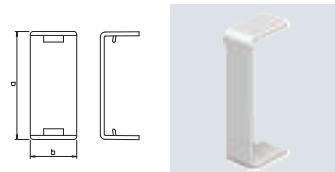

Joint cover for smooth connection of trunking segments.

Trunking height 20 mm, trunking width 50 mm

Internal corner cover, trunking type WDK 20050

PVC

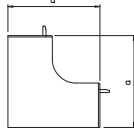

Type	Colour	Dim. mm	Pack Piece	Weight kg/100 pc.	Item no.
WDK HI20050RW	Pure white	45	4	1.277	6154360

Internal corner cover for changing the direction of the WDK trunking.

External corner cover, trunking type WDK 20050

PVC

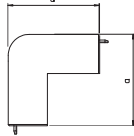

Type	Colour	Dim. mm	Pack Piece	Weight kg/100 pc.	Item no.
WDK HA20050RW	Pure white	45	4	1.765	6154468

External corner hood for changing the direction of the WDK trunking.

Flat angle cover, trunking type WDK 20050

PVC

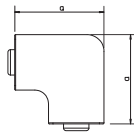

Type	Colour	Dim. mm	Pack Piece	Weight kg/100 pc.	Item no.
WDK HF20050RW	Pure white	73	4	1.948	6154255

Flat angle hood for changing the direction of the WDK trunking.

T piece cover, for trunking type WDK 20050

PVC

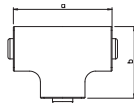

Type	Colour	Dim. mm	Dim. b mm	Pack Piece	Weight kg/100 pc.	Item no.
WDK HT20050RW	Pure white	93	73	4	2.146	6154166

T piece cover for changing the direction of the WDK trunking.

End piece, trunking type WDK 20050

PVC

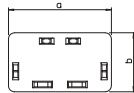
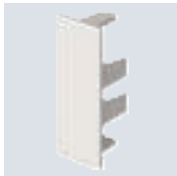

Type	Colour	Dim. mm	Dim. b mm	Pack Piece	Weight kg/100 pc.	Item no.
WDK HE20050RW	Pure white	50	20	10	0.425	6154557

End piece to close the WDK trunking.

PVC

Trunking, type WDK 25025

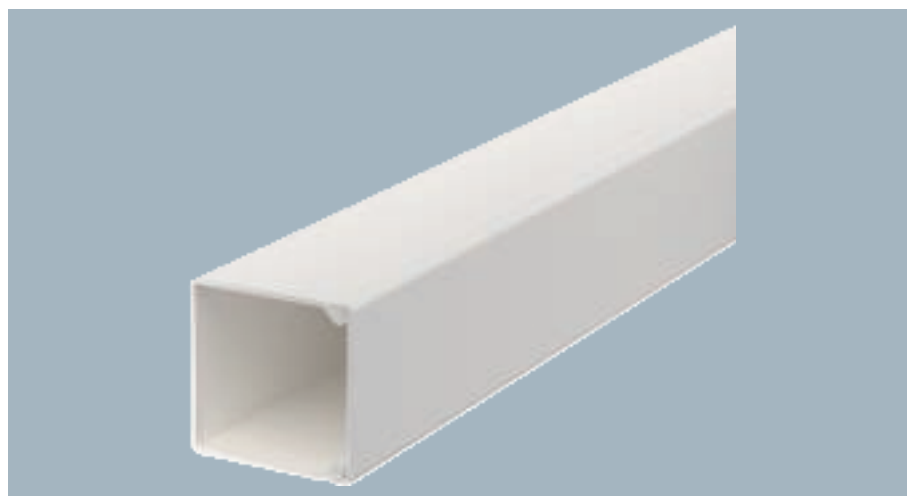
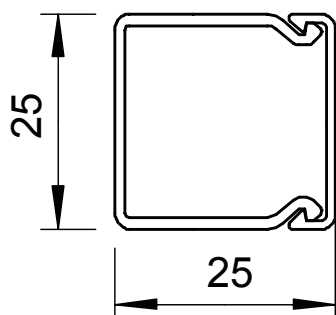

Trunking cover and base with base perforation.

Type	Colour	Length mm	Pack m	Weight kg/100 m	Item no.
WDK25025RW	Pure white	2000	30	24.500	6191053
WDK25025LGR	Light grey	2000	30	24.500	6026400
WDK25025GR	Stone grey	2000	30	24.500	6026419

PVC

Internal corner cover, trunking type WDK 25025

Type	Colour	Dim. mm	Pack Piece	Weight kg/100 pc.	Item no.
WDK HI25025RW	Pure white	50	4	1.150	6191886
WDK HI25025LGR	Light grey	50	4	1.669	6182062
WDK HI25025GR	Stone grey	50	4	1.669	6158250

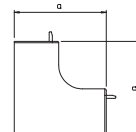

Internal corner cover for changing the direction of the WDK trunking.

PVC

External corner cover, for trunking type WDK 25025

Type	Colour	Dim. mm	Pack Piece	Weight kg/100 pc.	Item no.
WDK HA25025RW	Pure white	52	4	1.424	6192173
WDK HA25025LGR	Light grey	52	4	1.424	6182445
WDK HA25025GR	Stone grey	52	4	1.424	6158374

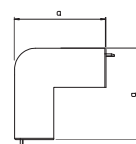

External corner hood for changing the direction of the WDK trunking.

PVC

Flat angle cover, trunking type WDK 25025

Type	Colour	Dim. mm	Pack Piece	Weight kg/100 pc.	Item no.
WDK HF25025RW	Pure white	48	4	1.055	6192785
WDK HF25025LGR	Light grey	48	4	1.000	6183255
WDK HF25025GR	Stone grey	48	4	1.000	6158617

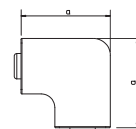

Flat angle cover for changing the direction of the WDK trunking.

Trunking height 25 mm, trunking width 25 mm

T piece cover, for trunking type WDK 25025

PVC

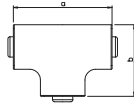

Type	Colour	Dim.		Pack Piece	Weight kg/100 pc.	Item no.
		mm	mm			
WDK HT25025RW	Pure white	68	48	4	1.171	6192483
WDK HT25025LGR	Light grey	68	48	4	1.171	6182852
WDK HT25025GR	Stone grey	68	48	4	1.171	6158498

T piece cover for changing the direction of the WDK trunking.

End piece, trunking type WDK 25025

PVC

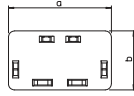

Type	Colour	Dim.		Pack Piece	Weight kg/100 pc.	Item no.
		mm	mm			
WDK HE25025RW	Pure white	25	25	10	0.303	6193145
WDK HE25025LGR	Light grey	25	25	10	0.303	6183662
WDK HE25025GR	Stone grey	25	25	10	0.303	6158730

End piece to close the WDK trunking.

PVC

Trunking, type WDK 25040

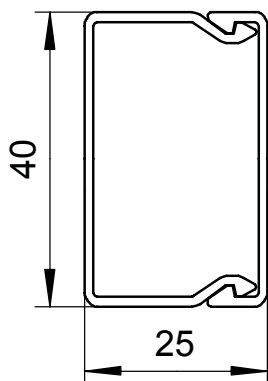

Trunking cover and base with base perforation.

Type	Colour	Length mm	Pack m	Weight kg/100 m	Item no.
WDK25040RW	Pure white	2000	24	30.000	6191061
WDK25040GR	Stone grey	2000	24	30.000	6026443
WDK25040LGR	Light grey	2000	24	30.000	6026486
WDK25040SW	Jet black	2000	24	30.000	6026488

PVC

Trunking, type WDK-N 25040

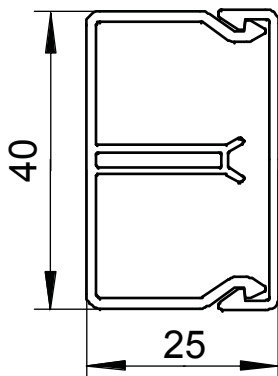

Trunking cover and base with base perforation.

Type	Colour	Length mm	Pack m	Weight kg/100 m	Item no.
WDK-N25040RW	Pure white	2000	48	36.000	6150640

PVC

Joint cover, for trunking, type WDK 25040

Type	Colour	Dim. mm	Dim. b mm	Pack Piece	Weight kg/100 pc.	Item no.
WDK HS25040RW	Pure white	42	14	10	0.231	6193560
WDK HS25040GR	Stone grey	42	14	10	0.231	6158889

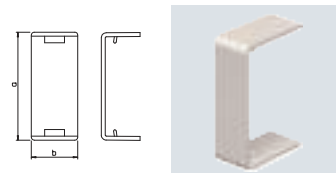

Joint cover for smooth connection of trunking segments.

Trunking height 25 mm, trunking width 40 mm

Internal corner cover, trunking type WDK 25040

PVC

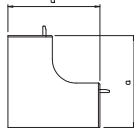

Type	Colour	Dim. mm	Pack Piece	Weight kg/100 pc.	Item no.
WDK HI25040RW	Pure white	50	4	1.502	6191894
WDK HI25040GR	Stone grey	50	4	1.489	6158269

Internal corner cover for changing the direction of the WDK trunking.

External corner cover, for trunking type WDK 25040

PVC

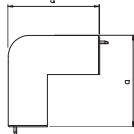

Type	Colour	Dim. mm	Pack Piece	Weight kg/100 pc.	Item no.
WDK HA25040RW	Pure white	52	4	2.052	6192181
WDK HA25040GR	Stone grey	52	4	2.052	6158382

External corner hood for changing the direction of the WDK trunking.

Flat angle cover, trunking type WDK 25040

PVC

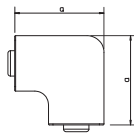

Type	Colour	Dim. mm	Pack Piece	Weight kg/100 pc.	Item no.
WDK HF25040RW	Pure white	63	4	1.905	6192793
WDK HF25040GR	Stone grey	63	4	1.905	6158625

Flat angle hood for changing the direction of the WDK trunking.

T piece cover, for trunking type WDK 25040

PVC

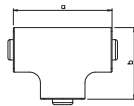

Type	Colour	Dim. mm	Dim. b mm	Pack Piece	Weight kg/100 pc.	Item no.
WDK HT25040RW	Pure white	83	63	4	1.994	6192491
WDK HT25040GR	Stone grey	83	63	4	1.994	6158501

T piece cover for changing the direction of the WDK trunking.

End piece, trunking type WDK 25040

PVC

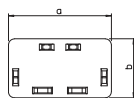

Type	Colour	Dim. mm	Dim. b mm	Pack Piece	Weight kg/100 pc.	Item no.
WDK HE25040RW	Pure white	40	25	10	0.404	6193153
WDK HE25040GR	Stone grey	40	25	10	0.404	6158749

End piece to close the WDK trunking.

PVC

Trunking, type WDK 30030

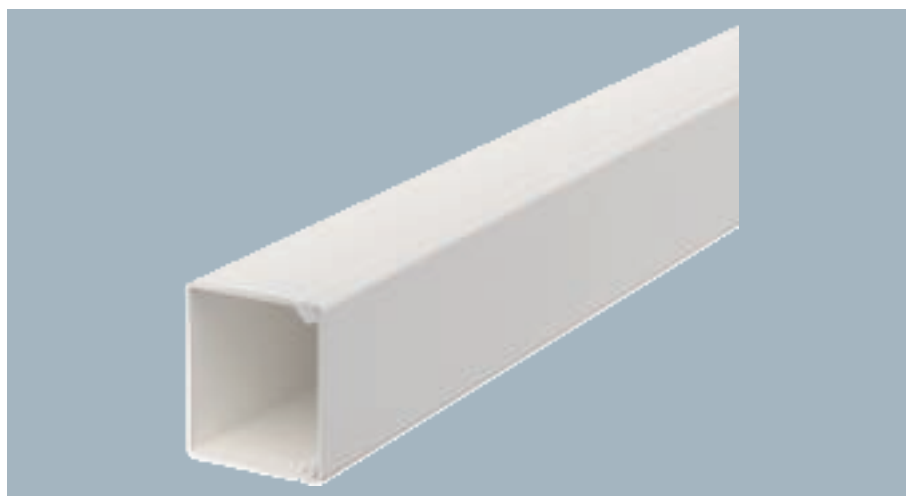
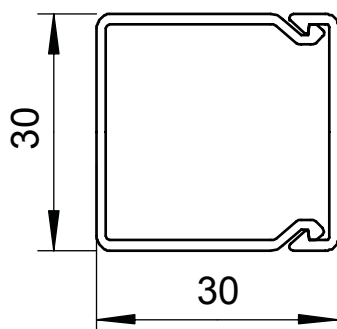

Trunking cover and base with base perforation.

Type	Colour	Length mm	Pack m	Weight kg/100 m	Item no.
WDK30030RW	Pure white	2000	40	24.900	6191096
WDK30030LGR	Light grey	2000	40	24.900	6026796
WDK30030GR	Stone grey	2000	40	24.900	6026818
WDK30030BR	Sepia brown	2000	40	24.900	6026834

PVC

Internal corner cover, trunking type WDK 30030

Type	Colour	Dim. mm	Pack Piece	Weight kg/100 pc.	Item no.
WDK HI30030RW	Pure white	52	4	1.345	6191924
WDK HI30030LGR	Light grey	52	4	1.349	6182097
WDK HI30030GR	Stone grey	52	4	1.200	6158285

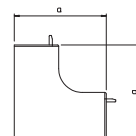

Internal corner cover for changing the direction of the WDK trunking.

PVC

External corner cover, trunking type WDK 30030

Type	Colour	Dim. mm	Pack Piece	Weight kg/100 pc.	Item no.
WDK HA30030RW	Pure white	57	4	1.776	6192211
WDK HA30030LGR	Light grey	57	4	1.809	6182488
WDK HA30030GR	Stone grey	57	4	1.809	6158404

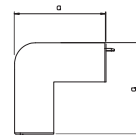

External corner hood for changing the direction of the WDK trunking.

PVC

Flat angle cover, trunking type WDK 30030

Type	Colour	Dim. mm	Pack Piece	Weight kg/100 pc.	Item no.
WDK HF30030RW	Pure white	53	4	1.370	6192815
WDK HF30030LGR	Light grey	53	4	1.370	6183298
WDK HF30030GR	Stone grey	53	4	1.370	6158641

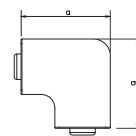

Flat angle hood for changing the direction of the WDK trunking.

Trunking height 30 mm, trunking width 30 mm

T piece cover, for trunking type WDK 30030

PVC

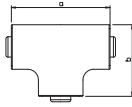

Type	Colour	Dim.		Pack Piece	Weight kg/100 pc.	Item no.
		mm	mm			
WDK HT30030RW	Pure white	50	39	4	1.542	6192513
WDK HT30030LGR	Light grey	50	39	4	1.485	6182887
WDK HT30030GR	Stone grey	50	39	4	1.485	6158536

T piece hood for changing the direction of the WDK trunking.

End piece, trunking type WDK 30030

PVC

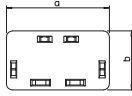

Type	Colour	Dim.		Pack Piece	Weight kg/100 pc.	Item no.
		mm	mm			
WDK HE30030RW	Pure white	30	30	10	0.363	6193188
WDK HE30030LGR	Light grey	30	30	10	0.365	6183697
WDK HE30030GR	Stone grey	30	30	10	0.365	6158765

End piece to close the WDK trunking.

PVC

Trunking, type WDK 30045

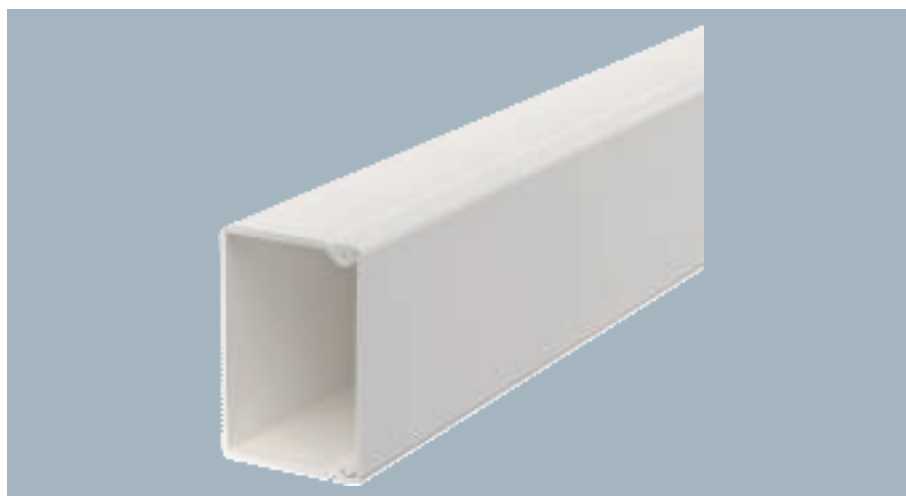
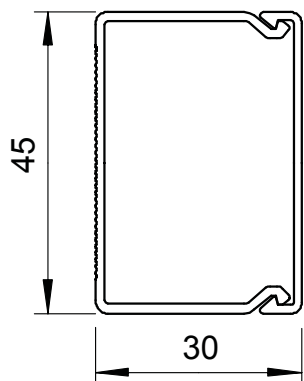

Trunking cover and base with base perforation.

Type	Colour	Length mm	Pack m	Weight kg/100 m	Item no.
WDK30045RW	Pure white	2000	48	32.000	6191118
WDK30045LGR	Light grey	2000	48	32.000	6026842
WDK30045GR	Stone grey	2000	48	32.000	6026850

PVC

Internal corner cover, trunking type WDK 30045

Type	Colour	Dim. mm	Pack Piece	Weight kg/100 pc.	Item no.
WDK HI30045RW	Pure white	52	4	1.295	6191932
WDK HI30045LGR	Light grey	52	4	1.295	6182100
WDK HI30045GR	Stone grey	52	4	1.295	6158307

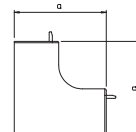

Internal corner cover for changing the direction of the WDK trunking.

PVC

External corner cover, trunking type WDK 30045

Type	Colour	Dim. mm	Pack Piece	Weight kg/100 pc.	Item no.
WDK HA30045RW	Pure white	57	4	2.319	6192238
WDK HA30045LGR	Light grey	57	4	2.319	6182496
WDK HA30045GR	Stone grey	57	4	2.319	6158420

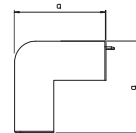

External corner hood for changing the direction of the WDK trunking.

PVC

Flat angle cover, trunking type WDK 30045

Type	Colour	Dim. mm	Pack Piece	Weight kg/100 pc.	Item no.
WDK HF30045RW	Pure white	68	4	1.922	6192823
WDK HF30045GR	Stone grey	68	4	1.922	6158676
WDK HF30045LGR	Light grey	68	4	1.922	6183301

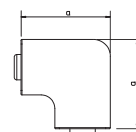

Flat angle hood for changing the direction of the WDK trunking.

Trunking height 30 mm, trunking width 45 mm

T piece cover, for trunking type WDK 30045

PVC

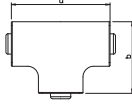

Type	Colour	Dim.		Pack Piece	Weight kg/100 pc.	Item no.
		mm	mm			
WDK HT30045RW	Pure white	88	68	4	2.003	6192521
WDK HT30045LGR	Light grey	88	68	4	2.003	6182895
WDK HT30045GR	Stone grey	88	68	4	2.003	6158552

T-piece cover for changing the direction of the WDK trunking.

End piece, trunking type WDK 30045

PVC

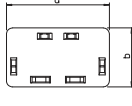

Type	Colour	Dim.		Pack Piece	Weight kg/100 pc.	Item no.
		mm	mm			
WDK HE30045RW	Pure white	45	30	10	0.514	6193196
WDK HE30045LGR	Light grey	45	30	10	0.509	6183700
WDK HE30045GR	Stone grey	45	30	10	0.509	6158803

End piece to close the WDK trunking.

PVC

Trunking, type WDK 40040

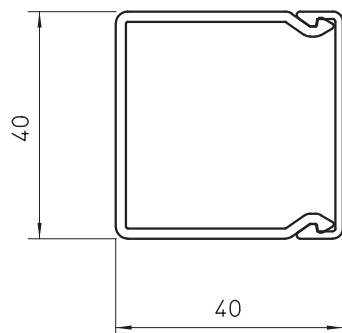

Trunking cover and base with base perforation.

Type	Colour	Length mm	Pack m	Weight kg/100 m	Item no.
WDK40040RW	Pure white	2000	36	42.100	6191126
WDK40040LGR	Light grey	2000	36	42.100	6027016
WDK40040GR	Stone grey	2000	36	42.100	6025447
WDK40040BR	Sepia brown	2000	36	42.100	6025420

PVC

Internal corner cover, trunking type WDK 40040

Type	Colour	Dim. mm	Pack Piece	Weight kg/100 pc.	Item no.
WDK HI40040RW	Pure white	65	4	2.502	6191940
WDK HI40040LGR	Light grey	65	4	2.502	6182119
WDK HI40040GR	Stone grey	65	4	2.502	6158293

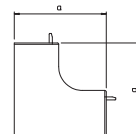

Internal corner cover for changing the direction of the WDK trunking.

PVC

External corner cover, trunking type WDK 40040

Type	Colour	Dim. mm	Pack Piece	Weight kg/100 pc.	Item no.
WDK HA40040RW	Pure white	66	4	3.139	6192246
WDK HA40040LGR	Light grey	66	4	3.139	6182526
WDK HA40040GR	Stone grey	66	4	3.139	6158412

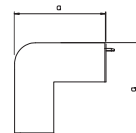

External corner hood for changing the direction of the WDK trunking.

PVC

Flat angle cover, trunking type WDK 40040

Type	Colour	Dim. mm	Pack Piece	Weight kg/100 pc.	Item no.
WDK HF40040RW	Pure white	63	4	2.534	6192831
WDK HF40040LGR	Light grey	63	4	2.534	6183336
WDK HF40040GR	Stone grey	63	4	2.534	6158668

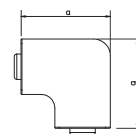

Flat angle cover for changing the direction of the WDK trunking.

Trunking height 40 mm, trunking width 40 mm

PVC

T and intersection cover, for trunking type WDK 40040

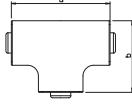

Type	Colour	Dim.		Pack Piece	Weight kg/100 pc.	Item no.
		mm	b mm			
WDK HT40040RW	Pure white	83	43	4	2.681	6192548
WDK HT40040LGR	Light grey	83	43	4	2.681	6182917
WDK HT40040GR	Stone grey	83	43	4	2.681	6158544

T and intersection cover for changing the direction of the WDK trunking. The fitting is preperforated at the side for the connection of different trunking cross-sections.

End piece, trunking type WDK 40040

PVC

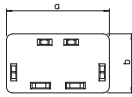
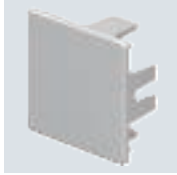

Type	Colour	Dim.		Pack Piece	Weight kg/100 pc.	Item no.
		mm	b mm			
WDK HE40040RW	Pure white	40	40	10	0.602	6193218
WDK HE40040LGR	Light grey	40	40	10	0.602	6183727
WDK HE40040GR	Stone grey	40	40	10	0.602	6158773

End piece to close the WDK trunking.

PVC

Trunking, type WDK 40060

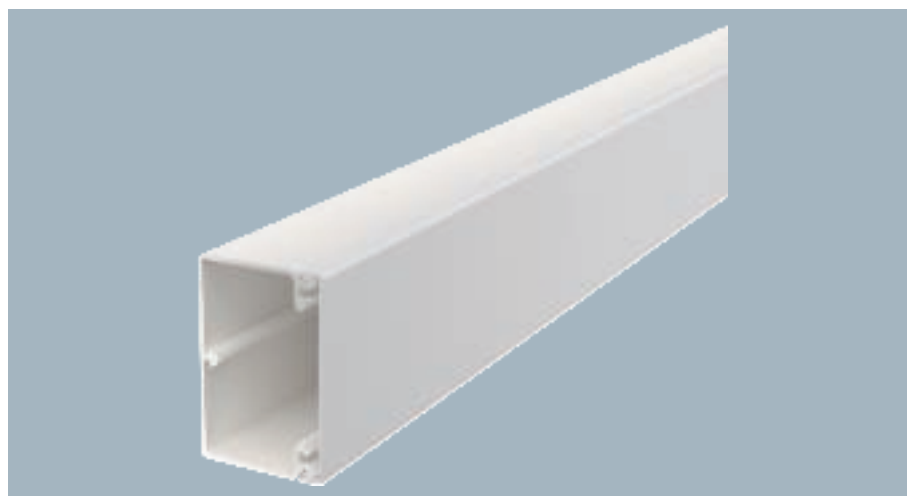
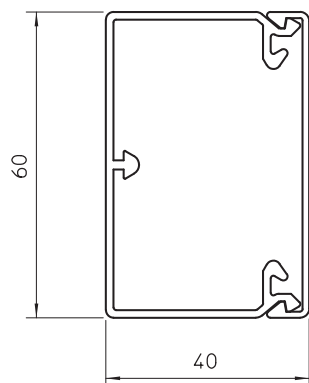

Trunking cover and base with base perforation.

Type	Colour	Length mm	Pack m	Weight kg/100 m	Item no.
WDK40060RW	Pure white	2000	32	56.200	6191134
WDK40060LGR	Light grey	2000	32	56.200	6027024
WDK40060GR	Stone grey	2000	32	56.200	6025633
WDK40060BR	Sepia brown	2000	32	56.200	6025617
WDK40060SW	Jet black	2000	32	56.200	6025638

PVC

Internal corner cover, trunking type WDK 40060

Type	Colour	Dim. mm	Pack Piece	Weight kg/100 pc.	Item no.
WDK HI40060RW	Pure white	110	2	7.363	6191959
WDK HI40060LGR	Light grey	110	2	7.363	6182127
WDK HI40060GR	Stone grey	110	2	7.363	6021719

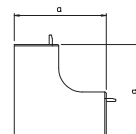

Internal corner cover for changing the direction of the WDK trunking.

PVC

External corner cover, trunking type WDK 40060

Type	Colour	Dim. mm	Pack Piece	Weight kg/100 pc.	Item no.
WDK HA40060RW	Pure white	100	2	8.653	6192254
WDK HA40060LGR	Light grey	100	2	8.653	6182534
WDK HA40060GR	Stone grey	100	2	8.653	6021697

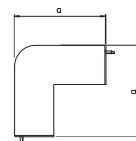

External corner hood for changing the direction of the WDK trunking.

PVC

Flat angle cover, trunking type WDK 40060

Type	Colour	Dim. mm	Pack Piece	Weight kg/100 pc.	Item no.
WDK HF40060RW	Pure white	101	2	6.271	6192858
WDK HF40060GR	Stone grey	101	2	6.271	6021735
WDK HF40060LGR	Light grey	101	2	6.271	6183344

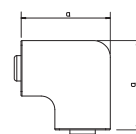

Flat angle hood for changing the direction of the WDK trunking.

Trunking height 40 mm, trunking width 60 mm

T and intersection cover, for trunking type WDK 40060

PVC

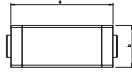

Type	Colour	Dim.		Pack Piece	Weight kg/100 pc.	Item no.
		mm	mm			
WDK HK40060RW	Pure white	190	63	2	9.801	6192556
WDK HK40060LGR	Light grey	190	63	2	9.801	6182925
WDK HK40060GR	Stone grey	190	63	2	9.801	6023312

T and intersection cover for changing the direction of the WDK trunking. The fitting is preperforated at the side for the connection of different trunking cross-sections.

End piece, trunking type WDK 40060

PVC

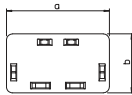

Type	Colour	Dim.		Pack Piece	Weight kg/100 pc.	Item no.
		mm	mm			
WDK HE40060RW	Pure white	60	40	10	1.136	6193226
WDK HE40060LGR	Light grey	60	40	10	1.148	6183735
WDK HE40060GR	Stone grey	60	40	10	1.144	6021492

End piece to close the WDK trunking.

PVC

Trunking, type WDK 40090

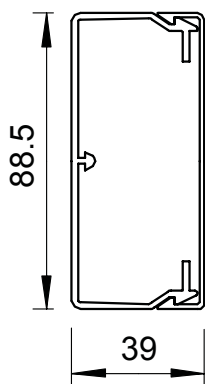

Trunking cover and base with base perforation.

Type	Colour	Length mm	Pack m	Weight kg/100 m	Item no.
WDK40090RW	Pure white	2000	32	77.300	6191142
WDK40090LGR	Light grey	2000	32	77.300	6027032
WDK40090GR	Stone grey	2000	32	77.300	6021018
WDK40090SW	Jet black	2000	32	78.100	6021023

PVC

Joint cover, for trunking, type WDK 40090

Type	Colour	Dim. mm	Dim. b mm	Pack Piece	Weight kg/100 pc.	Item no.
WDK HS40090RW	Pure white	90	39	20	0.857	6193580

Joint cover for hiding cut edges and for smooth connection of trunking segments.

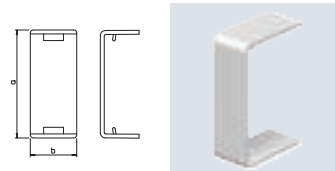

PVC

Internal corner cover, trunking type WDK 40090

Type	Colour	Dim. mm	Pack Piece	Weight kg/100 pc.	Item no.
WDK HI40090RW	Pure white	109	2	9.468	6191967
WDK HI40090LGR	Light grey	109	2	9.468	6182135
WDK HI40090GR	Stone grey	109	2	9.468	6021190

Internal corner cover for changing the direction of the WDK trunking.

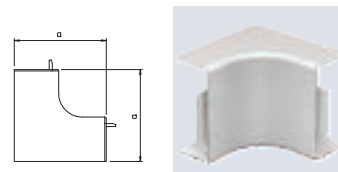

PVC

External corner cover, trunking type WDK 40090

Type	Colour	Dim. mm	Pack Piece	Weight kg/100 pc.	Item no.
WDK HA40090RW	Pure white	100	2	9.638	6192262
WDK HA40090LGR	Light grey	100	2	9.638	6182542
WDK HA40090GR	Stone grey	100	2	9.638	6021093

External corner hood for changing the direction of the WDK trunking.

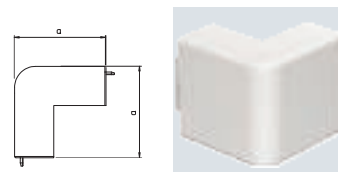

Trunking height 40 mm, trunking width 90 mm

Flat angle cover, trunking type WDK 40090

PVC

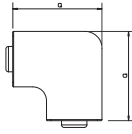

Type	Colour	Dim. mm	Pack Piece	Weight kg/100 pc.	Item no.
WDK HF40090RW	Pure white	129	2	11.246	6192866
WDK HF40090LGR	Light grey	129	2	11.246	6183352
WDK HF40090GR	Stone grey	129	2	11.246	6021336

Flat angle hood for changing the direction of the WDK trunking.

T and intersection cover, for trunking type WDK 40090

PVC

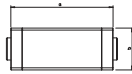

Type	Colour	Dim. mm	Dim. b mm	Pack Piece	Weight kg/100 pc.	Item no.
WDK HK40090RW	Pure white	230	91	2	13.986	6192564
WDK HK40090LGR	Light grey	230	91	2	13.986	6182933
WDK HK40090GR	Stone grey	230	91	2	13.986	6023142

T and intersection cover for changing the direction of the WDK trunking. The fitting is preperforated at the side for the connection of different trunking cross-sections.

End piece, trunking type WDK 40090

PVC

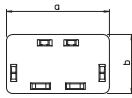

Type	Colour	Dim. mm	Dim. b mm	Pack Piece	Weight kg/100 pc.	Item no.
WDK HE40090RW	Pure white	90	40	10	1.576	6193234
WDK HE40090LGR	Light grey	90	40	10	1.566	6183743
WDK HE40090GR	Stone grey	90	40	10	1.576	6021506

End piece to close the WDK trunking.

PVC

Trunking, type WDK 40110

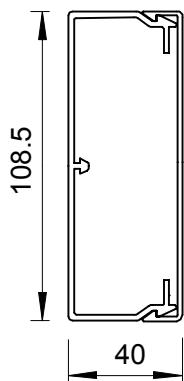

Trunking cover and base with base perforation.

Type	Colour	Length mm	Pack m	Weight kg/100 m	Item no.
WDK40110RW	Pure white	2000	24	111.800	6191150
WDK40110LGR	Light grey	2000	24	111.800	6027040
WDK40110GR	Stone grey	2000	24	111.800	6021034

PVC

Joint cover, for trunking, type WDK 40110

Type	Colour	Dim. mm	Dim. b mm	Pack Piece	Weight kg/100 pc.	Item no.
WDK HS40110RW	Pure white	110	39	20	0.974	6193586

Joint cover for hiding cut edges and for smooth connection of trunking segments.

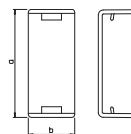

PVC

Internal corner cover, trunking type WDK 40110

Type	Colour	Dim. mm	Pack Piece	Weight kg/100 pc.	Item no.
WDK HI40110RW	Pure white	110.5	2	9.726	6191975
WDK HI40110LGR	Light grey	110.5	2	9.726	6182143
WDK HI40110GR	Stone grey	110.5	2	9.726	6021727

Internal corner cover for changing the direction of the WDK trunking.

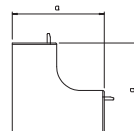

PVC

External corner cover, trunking type WDK 40110

Type	Colour	Dim. mm	Pack Piece	Weight kg/100 pc.	Item no.
WDK HA40110RW	Pure white	100	2	13.500	6192270
WDK HA40110LGR	Light grey	100	2	13.500	6182550
WDK HA40110GR	Stone grey	100	2	13.500	6021700

External corner hood for changing the direction of the WDK trunking.

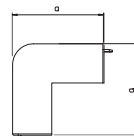

Trunking height 40 mm, trunking width 110 mm

Flat angle cover, trunking type WDK 40110

PVC

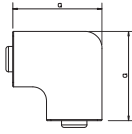

Type	Colour	Dim. mm	Pack Piece	Weight kg/100 pc.	Item no.
WDK HF40110RW	Pure white	110	2	13.000	6192874
WDK HF40110LGR	Light grey	110	2	13.000	6183360
WDK HF40110GR	Stone grey	110	2	11.751	6021743

Flat angle hood for changing the direction of the WDK trunking.

T and intersection cover, for trunking type WDK 40110

PVC

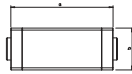

Type	Colour	Dim. mm	Dim. b mm	Pack Piece	Weight kg/100 pc.	Item no.
WDK HK40110RW	Pure white	272	112	2	18.882	6192572
WDK HK40110LGR	Light grey	272	112	2	18.882	6182941
WDK HK40110GR	Stone grey	272	112	2	18.882	6023339

T and intersection cover for changing the direction of the WDK trunking. The fitting is preperforated at the side for the connection of different trunking cross-sections.

End piece, trunking type WDK 40110

PVC

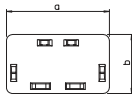

Type	Colour	Dim. mm	Dim. b mm	Pack Piece	Weight kg/100 pc.	Item no.
WDK HE40110RW	Pure white	110	40	10	1.919	6193242
WDK HE40110LGR	Light grey	110	40	10	1.859	6183751
WDK HE40110GR	Stone grey	110	40	10	1.859	6021514

End piece to close the WDK trunking.

PVC

Trunking, type WDK 60060

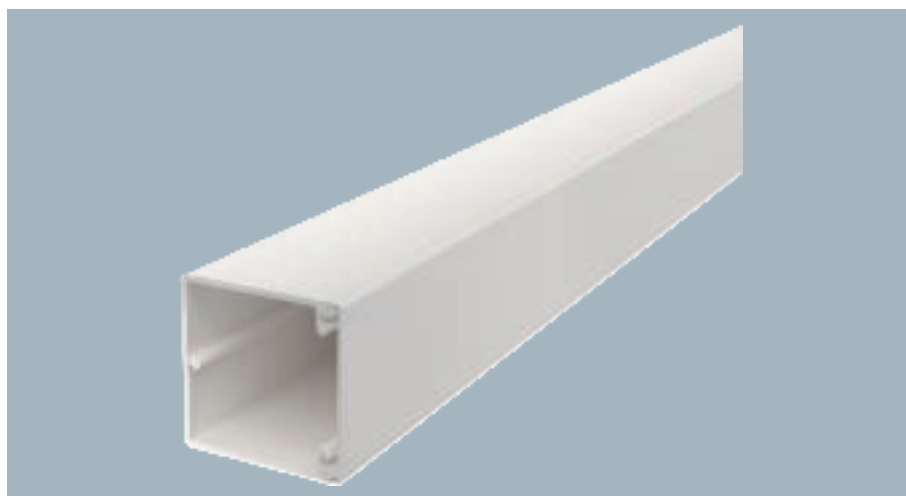
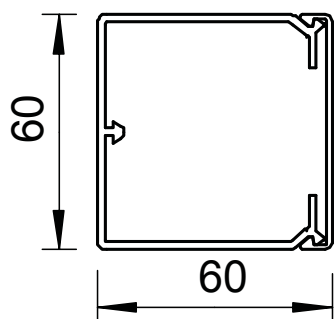

Trunking cover and base with base perforation.

Type	Colour	Length mm	Pack m	Weight kg/100 m	Item no.
WDK60060RW	Pure white	2000	32	81.600	6191193
WDK60060LGR	Light grey	2000	32	81.600	6027105
WDK60060GR	Stone grey	2000	32	81.600	6025668

PVC

Internal corner cover, trunking type WDK 60060

Type	Colour	Dim. mm	Pack Piece	Weight kg/100 pc.	Item no.
WDK HI60060RW	Pure white	130	2	10.932	6192017
WDK HI60060LGR	Light grey	130	2	10.932	6182194
WDK HI60060GR	Stone grey	130	2	10.932	6022383

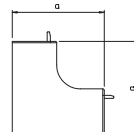

Internal corner cover for changing the direction of the WDK trunking.

PVC

External corner cover, trunking type WDK 60060

Type	Colour	Dim. mm	Pack Piece	Weight kg/100 pc.	Item no.
WDK HA60060RW	Pure white	100	2	9.931	6192319
WDK HA60060LGR	Light grey	100	2	9.931	6182593
WDK HA60060GR	Stone grey	100	2	9.931	6022073

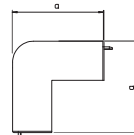

External corner hood for changing the direction of the WDK trunking.

PVC

Flat angle cover, trunking type WDK 60060

Type	Colour	Dim. mm	Pack Piece	Weight kg/100 pc.	Item no.
WDK HF60060RW	Pure white	101	2	7.846	6192912
WDK HF60060LGR	Light grey	101	2	8.243	6183409
WDK HF60060GR	Stone grey	101	2	8.016	6022448

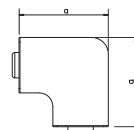

Flat angle hood for changing the direction of the WDK trunking.

Trunking height 60 mm, trunking width 60 mm

T and intersection cover, for trunking type WDK 60060

PVC

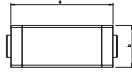

Type	Colour	Dim.		Pack Piece	Weight kg/100 pc.	Item no.
		mm	mm			
WDK HK60060RW	Pure white	190	65	2	12.876	6192610
WDK HK60060LGR	Light grey	190	65	2	12.876	6183018
WDK HK60060GR	Stone grey	190	65	2	12.876	6023223

T and intersection cover for changing the direction of the WDK trunking. The fitting is preperforated at the side for the connection of different trunking cross-sections.

End piece, trunking type WDK 60060

PVC

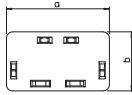

Type	Colour	Dim.		Pack Piece	Weight kg/100 pc.	Item no.
		mm	mm			
WDK HE60060RW	Pure white	60	60	10	1.551	6193285
WDK HE60060LGR	Light grey	60	60	10	1.551	6183808
WDK HE60060GR	Stone grey	60	60	10	1.544	6022499

End piece to close the WDK trunking.

PVC

Trunking, type WDK 60090

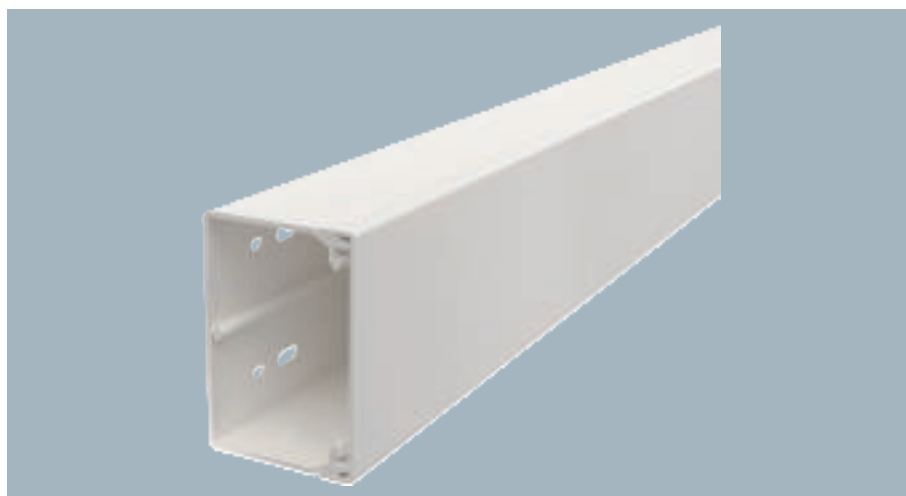
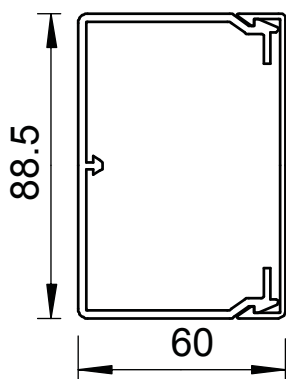

Trunking cover and base with base perforation.

Type	Colour	Length mm	Pack m	Weight kg/100 m	Item no.
WDK60090RW	Pure white	2000	24	110.000	6191207
WDK60090LGR	Light grey	2000	24	110.000	6027113
WDK60090GR	Stone grey	2000	24	110.000	6022006

PVC

Joint cover, for trunking, type WDK 60090

Type	Colour	Dim. mm	Dim. b mm	Pack Piece	Weight kg/100 pc.	Item no.
WDK HS60090RW	Pure white	94	18	20	1.002	6193590

Joint cover for hiding cut edges and for smooth connection of trunking segments.

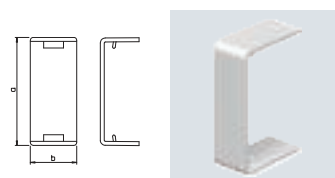

PVC

Internal corner cover, trunking type WDK 60090

Type	Colour	Dim. mm	Pack Piece	Weight kg/100 pc.	Item no.
WDK HI60090RW	Pure white	130	2	12.989	6192025
WDK HI60090LGR	Light grey	130	2	12.989	6182208
WDK HI60090GR	Stone grey	130	2	12.989	6022219

Internal corner cover for changing the direction of the WDK trunking.

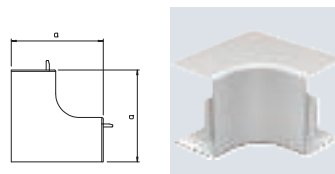

PVC

External corner cover, trunking type WDK 60090

Type	Colour	Dim. mm	Pack Piece	Weight kg/100 pc.	Item no.
WDK HA60090RW	Pure white	100	2	10.965	6192327
WDK HA60090LGR	Light grey	100	2	10.965	6182607
WDK HA60090GR	Stone grey	100	2	10.965	6022111

External corner hood for changing the direction of the WDK trunking.

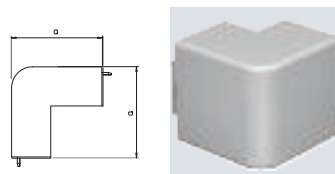

Trunking height 60 mm, trunking width 90 mm

Flat angle cover, trunking type WDK 60090

PVC

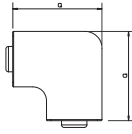

Type	Colour	Dim. mm	Pack Piece	Weight kg/100 pc.	Item no.
WDK HF60090RW	Pure white	129	2	11.454	6192920
WDK HF60090LGR	Light grey	129	2	11.454	6183417
WDK HF60090GR	Stone grey	129	2	11.454	6022316

Flat angle hood for changing the direction of the WDK trunking.

T and intersection cover, for trunking type WDK 60090

PVC



Type	Colour	Dim. mm	Dim. b mm	Pack Piece	Weight kg/100 pc.	Item no.
WDK HK60090RW	Pure white	230	94	2	16.992	6192629
WDK HK60090LGR	Light grey	230	94	2	16.992	6183026
WDK HK60090GR	Stone grey	230	94	2	16.992	6023002

T and intersection cover for changing the direction of the WDK trunking. The fitting is preperforated at the side for the connection of different trunking cross-sections.

End piece, trunking type WDK 60090

PVC

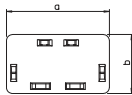

Type	Colour	Dim. mm	Dim. b mm	Pack Piece	Weight kg/100 pc.	Item no.
WDK HE60090RW	Pure white	90	60	10	2.315	6193293
WDK HE60090LGR	Light grey	90	60	10	2.337	6183816
WDK HE60090GR	Stone grey	90	60	10	2.337	6022502

End piece to close the WDK trunking.

PVC

Trunking, type WDK 60110

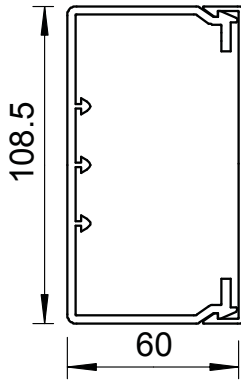

Trunking cover and base with base perforation.

Type	Colour	Length mm	Pack m	Weight kg/100 m	Item no.
WDK60110RW	Pure white	2000	16	117.000	6191215
WDK60110LGR	Light grey	2000	16	117.000	6027121
WDK60110GR	Stone grey	2000	16	117.000	6022014

PVC

Joint cover, for trunking, type WDK 60110

Type	Colour	Dim. mm	Dim. b mm	Pack Piece	Weight kg/100 pc.	Item no.
WDK HS60110RW	Pure white	113	18	20	1.142	6193596

Joint cover for hiding cut edges and for smooth connection of trunking segments.

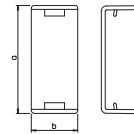

PVC

Internal corner cover, trunking type WDK 60110

Type	Colour	Dim. mm	Pack Piece	Weight kg/100 pc.	Item no.
WDK HI60110RW	Pure white	130	2	13.254	6192033
WDK HI60110LGR	Light grey	130	2	13.102	6182216
WDK HI60110GR	Stone grey	130	2	13.312	6022235

Internal corner cover for changing the direction of the WDK trunking.

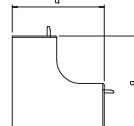

PVC

External corner cover, trunking type WDK 60110

Type	Colour	Dim. mm	Pack Piece	Weight kg/100 pc.	Item no.
WDK HA60110RW	Pure white	100	2	13.226	6192335
WDK HA60110LGR	Light grey	100	2	13.226	6182615
WDK HA60110GR	Stone grey	100	2	13.049	6022146

External corner hood for changing the direction of the WDK trunking.

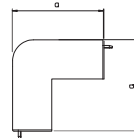

Flat angle cover, trunking type WDK 60110

PVC

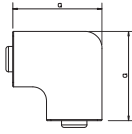

Type	Colour	Dim. mm	Pack Piece	Weight kg/100 pc.	Item no.
WDK HF60110RW	Pure white	149	2	14.273	6192939
WDK HF60110LGR	Light grey	149	2	14.399	6183425
WDK HF60110GR	Stone grey	149	2	14.399	6022332

Flat angle hood for changing the direction of the WDK trunking.

T and intersection cover, for trunking type WDK 60110

PVC



Type	Colour	Dim. mm	Dim. b mm	Pack Piece	Weight kg/100 pc.	Item no.
WDK HK60110RW	Pure white	272	114	2	22.905	6192637
WDK HK60110LGR	Light grey	272	114	2	22.905	6183034
WDK HK60110GR	Stone grey	272	114	2	22.905	6023029

T and intersection cover for changing the direction of the WDK trunking. The fitting is preperforated at the side for the connection of different trunking cross-sections.

End piece, trunking type WDK 60110

PVC

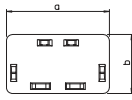

Type	Colour	Dim. mm	Dim. b mm	Pack Piece	Weight kg/100 pc.	Item no.
WDK HE60110RW	Pure white	110	60	10	2.937	6193307
WDK HE60110LGR	Light grey	110	60	10	2.912	6183824
WDK HE60110GR	Stone grey	110	60	10	2.951	6022588

End piece for closing the WDK trunking.

PVC

Trunking, type WDK 60130

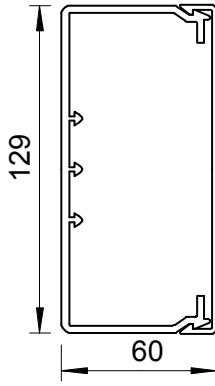

Trunking cover and base with base perforation.

Type	Colour	Length mm	Pack m	Weight kg/100 m	Item no.
WDK60130RW	Pure white	2000	16	135.000	6191223
WDK60130LGR	Light grey	2000	16	135.000	6027148
WDK60130GR	Stone grey	2000	16	135.000	6022022

PVC

Internal corner cover, trunking type WDK 60130

Type	Colour	Dim. mm	Pack Piece	Weight kg/100 pc.	Item no.
WDK HI60130RW	Pure white	130	2	13.526	6192041
WDK HI60130LGR	Light grey	130	2	13.526	6182224
WDK HI60130GR	Stone grey	130	2	13.526	6022251

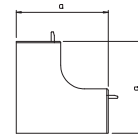

Internal corner cover for changing the direction of the WDK trunking.

PVC

External corner cover, trunking type WDK 60130

Type	Colour	Dim. mm	Pack Piece	Weight kg/100 pc.	Item no.
WDK HA60130RW	Pure white	100	2	14.327	6192343
WDK HA60130LGR	Light grey	100	2	14.327	6182623
WDK HA60130GR	Stone grey	100	2	14.327	6022162

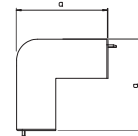

External corner hood for changing the direction of the WDK trunking.

PVC

Flat angle cover, trunking type WDK 60130

Type	Colour	Dim. mm	Pack Piece	Weight kg/100 pc.	Item no.
WDK HF60130RW	Pure white	170	2	17.118	6192947
WDK HF60130LGR	Light grey	170	2	17.272	6183433
WDK HF60130GR	Stone grey	170	2	17.272	6022359

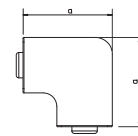

Flat angle hood for changing the direction of the WDK trunking.

T and intersection cover, for trunking type WDK 60130

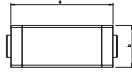

Type	Colour	Dim.		Pack Piece	Weight kg/100 pc.	Item no.
		mm	mm			
WDK HK60130RW	Pure white	272	65	2	23.968	6192645
WDK HK60130LGR	Light grey	272	65	2	23.968	6183042
WDK HK60130GR	Stone grey	272	65	2	23.968	6023045

T and intersection cover for changing the direction of the WDK trunking. The fitting is preperforated at the side for the connection of different trunking cross-sections.

End piece, trunking type WDK 60130

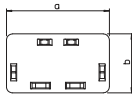

Type	Colour	Dim.		Pack Piece	Weight kg/100 pc.	Item no.
		mm	mm			
WDK HE60130RW	Pure white	130	61	10	3.610	6193315
WDK HE60130LGR	Light grey	130	61	10	3.655	6183832
WDK HE60130GR	Stone grey	130	61	10	3.578	6022529

End piece to close the WDK trunking.

PVC

Trunking, type WDK 60150

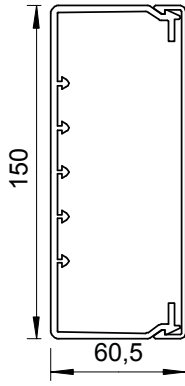

Trunking cover and base with base perforation.

Type	Colour	Length mm	Pack m	Weight kg/100 m	Item no.
WDK60150RW	Pure white	2000	8	175.000	6191231
WDK60150LGR	Light grey	2000	8	175.000	6027156
WDK60150GR	Stone grey	2000	8	175.000	6022030

PVC

Internal corner cover, trunking type WDK 60150

Type	Colour	Dim. mm	Pack Piece	Weight kg/100 pc.	Item no.
WDK HI60150RW	Pure white	130	2	14.449	6192068
WDK HI60150LGR	Light grey	130	2	14.449	6182232
WDK HI60150GR	Stone grey	130	2	14.449	6024432

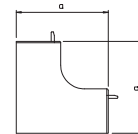

Internal corner cover for changing the direction of the WDK trunking.

PVC

External corner cover, trunking type WDK 60150

Type	Colour	Dim. mm	Pack Piece	Weight kg/100 pc.	Item no.
WDK HA60150RW	Pure white	100	2	17.452	6192351
WDK HA60150LGR	Light grey	100	2	17.452	6182631
WDK HA60150GR	Stone grey	100	2	17.452	6024521

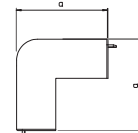

External corner hood for changing the direction of the WDK trunking.

PVC

Flat angle cover, trunking type WDK 60150

Type	Colour	Dim. mm	Pack Piece	Weight kg/100 pc.	Item no.
WDK HF60150RW	Pure white	190	2	19.910	6192955
WDK HF60150LGR	Light grey	190	2	19.910	6183441
WDK HF60150GR	Stone grey	190	2	19.910	6024599

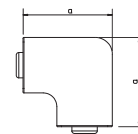

Flat angle hood for changing the direction of the WDK trunking.

T and intersection cover, for trunking type WDK 60150

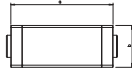

Type	Colour	Dim.		Pack Piece	Weight kg/100 pc.	Item no.
		mm	mm			
WDK HK60150RW	Pure white	291	155	2	26.831	6192653
WDK HK60150LGR	Light grey	291	155	2	26.831	6183050
WDK HK60150GR	Stone grey	291	155	2	26.831	6024769

T and intersection cover for changing the direction of the WDK trunking. The fitting is preperforated at the side for the connection of different trunking cross-sections.

End piece, trunking type WDK 60150

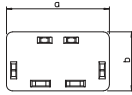

Type	Colour	Dim.		Pack Piece	Weight kg/100 pc.	Item no.
		mm	mm			
WDK HE60150RW	Pure white	150	60	10	4.118	6193323
WDK HE60150LGR	Light grey	150	60	10	4.827	6183840
WDK HE60150GR	Stone grey	150	60	10	4.223	6024823

End piece to close the WDK trunking.

PVC

Trunking, type WDK 60170

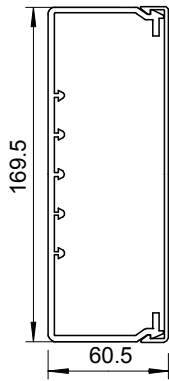

Trunking cover and base with base perforation.

Type	Colour	Length mm	Pack m	Weight kg/100 m	Item no.
WDK60170RW	Pure white	2000	8	178.000	6191258
WDK60170CW	Cream	2000	8	178.000	6021867
WDK60170LGR	Light grey	2000	8	178.000	6027164
WDK60170GR	Stone grey	2000	8	178.000	6022049

PVC

Internal corner cover, trunking type WDK 60170

Type	Colour	Dim. mm	Pack Piece	Weight kg/100 pc.	Item no.
WDK HI60170RW	Pure white	130	2	12.472	6192076
WDK HI60170LGR	Light grey	130	2	12.472	6182240
WDK HI60170GR	Stone grey	130	2	12.472	6022286
WDK HI60170CW	Cream	130	2	12.472	6160352

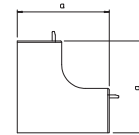

Internal corner cover for changing the direction of the WDK trunking.

PVC

External corner cover, trunking type WDK 60170

Type	Colour	Dim. mm	Pack Piece	Weight kg/100 pc.	Item no.
WDK HA60170RW	Pure white	100	2	17.750	6192378
WDK HA60170LGR	Light grey	100	2	17.750	6182658
WDK HA60170GR	Stone grey	100	2	17.750	6022189
WDK HA60170CW	Cream	100	2	17.750	6160956

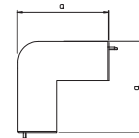

External corner hood for changing the direction of the WDK trunking.

PVC

Flat angle cover, trunking type WDK 60170

Type	Colour	Dim. mm	Pack Piece	Weight kg/100 pc.	Item no.
WDK HF60170RW	Pure white	211	2	22.774	6192963
WDK HF60170LGR	Light grey	211	2	22.774	6183468
WDK HF60170GR	Stone grey	211	2	22.774	6022375
WDK HF60170CW	Cream	211	2	22.774	6161545

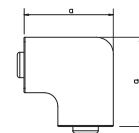

Flat angle hood for changing the direction of the WDK trunking.

T and intersection cover, for trunking type WDK 60170

PVC

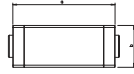

Type	Colour	Dim.		Pack Piece	Weight kg/100 pc.	Item no.
		mm	mm			
WDK HK60170RW	Pure white	291	66	2	32.600	6192661
WDK HK60170LGR	Light grey	291	66	2	32.600	6183069
WDK HK60170GR	Stone grey	291	66	2	32.600	6023061
WDK HK60170CW	Cream	291	66	2	32.600	6162258

T and intersection cover for changing the direction of the WDK trunking. The fitting is preperforated at the side for the connection of different trunking cross-sections.

End piece, trunking type WDK 60170

PVC

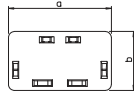

Type	Colour	Dim.		Pack Piece	Weight kg/100 pc.	Item no.
		mm	mm			
WDK HE60170RW	Pure white	170	60	10	4.859	6193331
WDK HE60170LGR	Light grey	170	60	10	4.859	6183859
WDK HE60170GR	Stone grey	170	60	10	4.859	6022545
WDK HE60170CW	Cream	170	60	10	4.859	6162843

End piece to close the WDK trunking.

PVC

Trunking, type WDK 60210

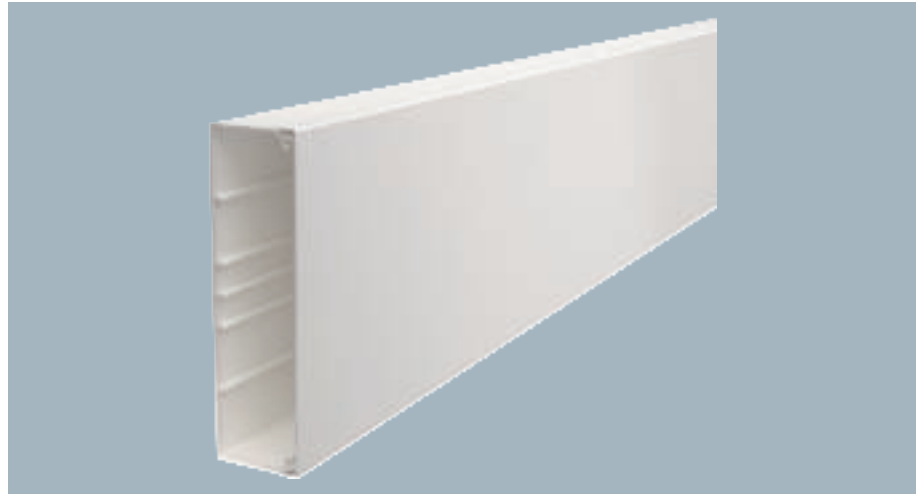
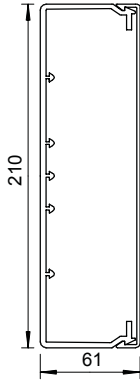

Trunking cover and base with base perforation.

Type	Colour	Length mm	Pack m	Weight kg/100 m	Item no.
WDK60210RW	Pure white	2000	8	258.000	6191266
WDK60210LGR	Light grey	2000	8	258.000	6027172
WDK60210GR	Stone grey	2000	8	258.000	6022065

PVC

Internal corner cover, trunking type WDK 60210

Type	Colour	Dim. mm	Pack Piece	Weight kg/100 pc.	Item no.
WDK HI60210RW	Pure white	130	2	17.594	6192084
WDK HI60210LGR	Light grey	130	2	17.594	6182259
WDK HI60210GR	Stone grey	130	2	17.594	6022294

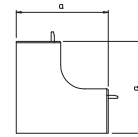

Internal corner cover for changing the direction of the WDK trunking.

PVC

External corner cover, trunking type WDK 60210

Type	Colour	Dim. mm	Pack Piece	Weight kg/100 pc.	Item no.
WDK HA60210RW	Pure white	100	2	20.357	6192386
WDK HA60210LGR	Light grey	100	2	20.357	6182666
WDK HA60210GR	Stone grey	100	2	20.357	6022197

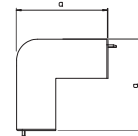

External corner hood for changing the direction of the WDK trunking.

PVC

Flat angle cover, trunking type WDK 60210

Type	Colour	Dim. mm	Pack Piece	Weight kg/100 pc.	Item no.
WDK HF60210RW	Pure white	250	2	30.182	6192971
WDK HF60210LGR	Light grey	250	2	38.000	6183476
WDK HF60210GR	Stone grey	250	2	38.000	6022391

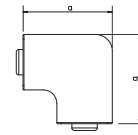

Flat angle hood for changing the direction of the WDK trunking.

T and intersection cover, for trunking type WDK 60210

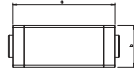

Type	Colour	Dim.		Pack Piece	Weight kg/100 pc.	Item no.
		mm	b mm			
WDK HK60210RW	Pure white	291	66	2	35.280	6192688
WDK HK60210LGR	Light grey	291	66	2	35.280	6183077
WDK HK60210GR	Stone grey	291	66	2	35.280	6023126

T and intersection cover for changing the direction of the WDK trunking. The fitting is preperforated at the side for the connection of different trunking cross-sections.

End piece, trunking type WDK 60210

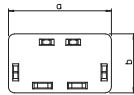

Type	Colour	Dim.		Pack Piece	Weight kg/100 pc.	Item no.
		mm	b mm			
WDK HE60210RW	Pure white	210	60	10	5.475	6193358
WDK HE60210LGR	Light grey	210	60	10	5.646	6183867
WDK HE60210GR	Stone grey	210	60	10	5.479	6022561

End piece to close the WDK trunking.

PVC

Trunking, type WDK 60230

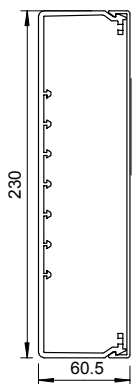

Trunking cover and base with base perforation.
Four cover fixing devices included.

Type	Colour	Length mm	Pack m	Weight kg/100 m	Item no.
WDK60230RW	Pure white	2000	8	298.000	6191274
WDK60230LGR	Light grey	2000	8	298.000	6027180
WDK60230GR	Stone grey	2000	8	298.000	6022057

PVC

Internal corner cover, trunking type WDK 60230

Type	Colour	Dim. mm	Pack Piece	Weight kg/100 pc.	Item no.
WDK HI60230RW	Pure white	130	2	22.509	6192092
WDK HI60230LGR	Light grey	130	2	22.509	6182267
WDK HI60230GR	Stone grey	130	2	22.509	6024440

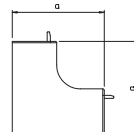

Internal corner cover for changing the direction of the WDK trunking.

PVC

External corner cover, trunking type WDK 60230

Type	Colour	Dim. mm	Pack Piece	Weight kg/100 pc.	Item no.
WDK HA60230RW	Pure white	100	2	24.645	6192394
WDK HA60230LGR	Light grey	100	2	24.645	6182674
WDK HA60230GR	Stone grey	100	2	24.645	6024548

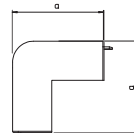

External corner hood for changing the direction of the WDK trunking.

PVC

T and intersection cover, for trunking type WDK 60210

Type	Colour	Dim. mm	Dim. b mm	Pack Piece	Weight kg/100 pc.	Item no.
WDK HK60230RW	Pure white	291	235	2	39.600	6192696
WDK HK60230LGR	Light grey	291	235	2	39.600	6183085
WDK HK60230GR	Stone grey	291	235	2	39.600	6024777

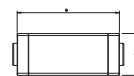

T and intersection cover for changing the direction of the WDK trunking. The fitting is preperforated at the side for the connection of different trunking cross-sections.

Trunking height 60 mm, trunking width 230 mm

Flat angle cover, trunking type WDK 60230

PVC

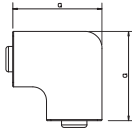

Type	Colour	Dim. mm	Pack Piece	Weight kg/100 pc.	Item no.
WDK HF60230RW	Pure white	270	2	47.856	6192998
WDK HF60230LGR	Light grey	270	2	47.856	6183484
WDK HF60230GR	Stone grey	270	2	47.856	6024602

Flat angle hood for changing the direction of the WDK trunking.

End piece, trunking type WDK 60230

PVC

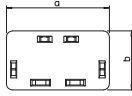

Type	Colour	Dim. mm	Dim. b mm	Pack Piece	Weight kg/100 pc.	Item no.
WDK HE60230RW	Pure white	230	60	10	6.283	6193366
WDK HE60230LGR	Light grey	230	60	10	6.283	6183875
WDK HE60230GR	Stone grey	230	60	10	6.283	6024831

End piece to close the WDK trunking.

The end pieces are pushed onto the trunking and kept in place by the spring action.

PVC

Trunking, type WDK 80170

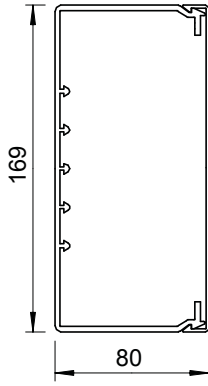

Wall installation trunking as trunking base with base perforation and matching trunking cover.

Type	Colour	Length mm	Pack m	Weight kg/100 m	Item no.
WDK80170RW	Pure white	2000	8	214.000	6191304
WDK80170CW	Cream	2000	8	214.000	6026176
WDK80170LGR	Light grey	2000	8	214.000	6027229
WDK80170GR	Stone grey	2000	8	214.000	6026184

PVC

End piece, trunking type WDK 80170

Type	Colour	Dim. mm	Dim. b mm	Pack Piece	Weight kg/100 pc.	Item no.
WDK HE80170RW	Pure white	150	170	10	11.900	6193387
WDK HE80170LGR	Light grey	150	170	10	11.900	6183913
WDK HE80170GR	Stone grey	150	170	10	11.900	6024858

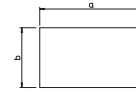

End piece to close the WDK trunking.

Trunking height 80 mm, trunking width 210 mm

Trunking, type WDK 80210

PVC

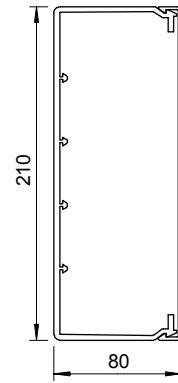

Type	Colour	Length mm	Pack m	Weight kg/100 m	Item no.
WDK80210RW	Pure white	2000	8	240.000	6191312
WDK80210LGR	Light grey	2000	8	240.000	6027237
WDK80210GR	Stone grey	2000	8	240.000	6026192

Wall installation trunking as trunking base with base perforation and matching trunking cover.

Four cover fixing devices included

End piece, trunking type WDK 80210

PVC

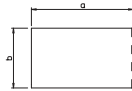

Type	Colour	Dim. mm	Dim. b mm	Pack	Weight	Item no.
				Piece	kg/100 pc.	
WDK HE80210RW	Pure white	150	80	10	14.500	6193391
WDK HE80210LGR	Light grey	150	210	10	14.500	6183921
WDK HE80210GR	Stone grey	150	210	10	14.500	6024874

End piece to close the WDK trunking.

PVC

Trunking, type WDK 100130

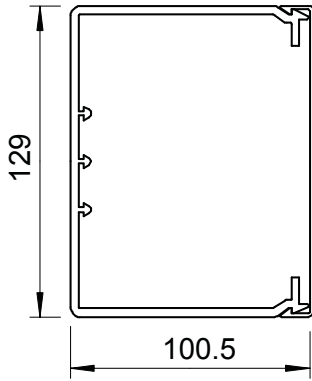

Wall installation trunking as trunking base with base perforation and matching trunking cover.
Four cover fixing devices included

Type	Colour	Length mm	Pack m	Weight kg/100 m	Item no.
WDK100130RW	Pure white	2000	8	214.000	6191347
WDK100130CW	Cream	2000	8	214.000	6026273
WDK100130LGR	Light grey	2000	8	214.000	6027245
WDK100130GR	Stone grey	2000	8	214.000	6026281

PVC

End piece, trunking type WDK 100130

Type	Colour	Dim. mm	Dim. b mm	Pack Piece	Weight kg/100 pc.	Item no.
WDK HE100130RW	Pure white	150	130	10	8.200	6193395
WDK HE100130LGR	Light grey	150	130	10	8.200	6183956
WDK HE100130GR	Stone grey	150	130	10	8.200	6024882

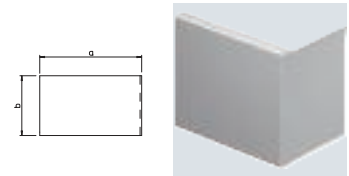

End piece to close the WDK trunking.

Trunking height 100 mm, trunking width 230 mm

Trunking, type WDK 100230

PVC

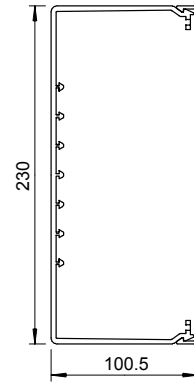

Type	Colour	Length mm	Pack m	Weight kg/100 m	Item no.
WDK100230RW	Pure white	2000	4	338.000	6191355
WDK100230LGR	Light grey	2000	4	338.000	6027253
WDK100230GR	Stone grey	2000	4	338.000	6026311
WDK100230CW	Cream	2000	4	338.000	6026338

Wall installation trunking as trunking base with base perforation and matching trunking cover.
Four cover fixing devices included.

End piece, trunking type WDK 100230

PVC

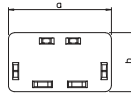

Type	Colour	Dim. mm	Dim. b mm	Pack Piece	Weight kg/100 pc.	Item no.
WDK HE100230RW	Pure white	230	100	5	10.409	6193399
WDK HE100230LGR	Light grey	230	100	5	10.237	6183980
WDK HE100230GR	Stone grey	230	100	5	10.237	6024904

End piece to close the WDK trunking.



Trunking, type WDKH 10020

PC/
ABS

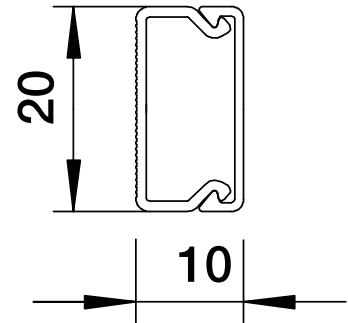
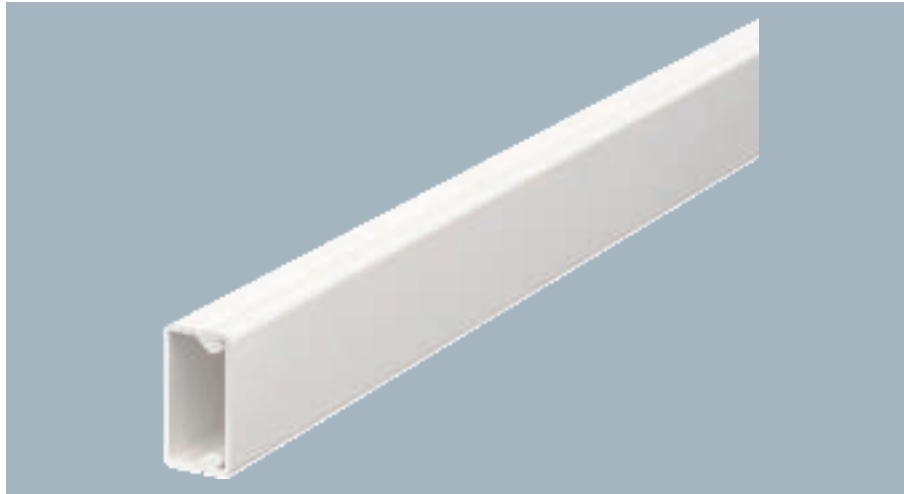

Type	Colour	Length mm	Pack m	Weight kg/100 m	Item no.
WDKH-10020RW	Pure white	2000	96	8.500	6175375

Trunking cover and base with base perforation made of halogen-free plastic.

Trunking, type WDKH 10020

PC/
ABS

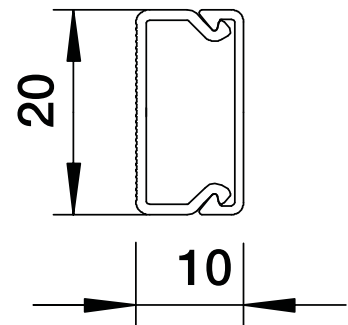
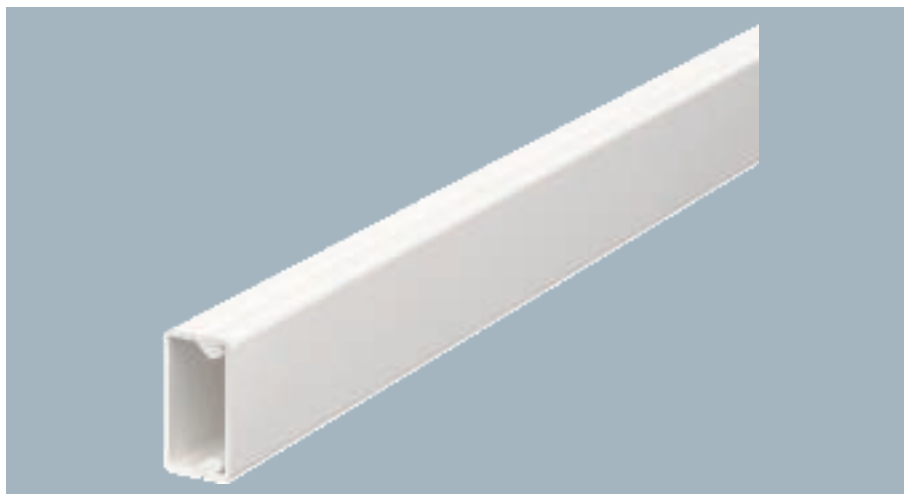

Type	Colour	Length mm	Pack m	Weight kg/100 m	Item no.
WDKH-10020RW T	Pure white	2000	84	9.500	6175377

Trunking cover and base with base perforation made of halogen-free plastic.

Internal corner cover, trunking type WDKH 10020

PC/
ABS

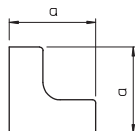

Type	Colour	Dim. mm	Pack Piece	Weight kg/100 pc.	Item no.
WDKH-110020RW	Pure white	30	4	0.252	6175572

Internal corner cover for changing the direction of the halogen-free WDKH trunking.

PC / ABS

External corner cover, trunking type WDKH 10020

Type	Colour	Dim. mm	Pack Piece	Weight kg/100 pc.	Item no.
WDKH-A10020RW	Pure white	30	4	0.332	6175612

External corner cover for changing the direction of the halogen-free WDKH trunking.

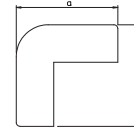

PC / ABS

Flat angle cover, trunking type WDKH 10020

Type	Colour	Dim. mm	Pack Piece	Weight kg/100 pc.	Item no.
WDKH-F10020RW	Pure white	40	4	0.308	6175648

Flat angle hood for changing the direction of the halogen-free WDKH trunking.

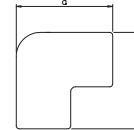

PC / ABS

T piece cover, for trunking type WDKH 10020

Type	Colour	Dim. mm	Dim. b mm	Pack Piece	Weight kg/100 pc.	Item no.
WDKH-T10020RW	Pure white	45	34	4	0.298	6175684

T and intersection cover for changing the direction of the halogen-free WDK-H trunking.

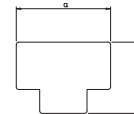

PC / ABS

End piece, trunking type WDKH 10020

Type	Colour	Dim. mm	Dim. b mm	Pack Piece	Weight kg/100 pc.	Item no.
WDKH-E10020RW	Pure white	22	11	10	0.092	6175540

End piece for closing the WDK-H trunking.

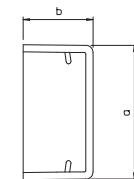

Trunking, type WDKH 15030

PC/
ABS

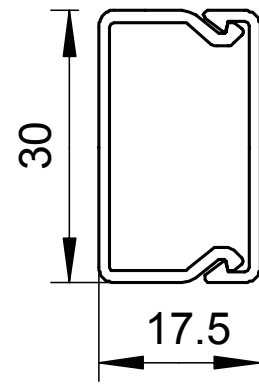
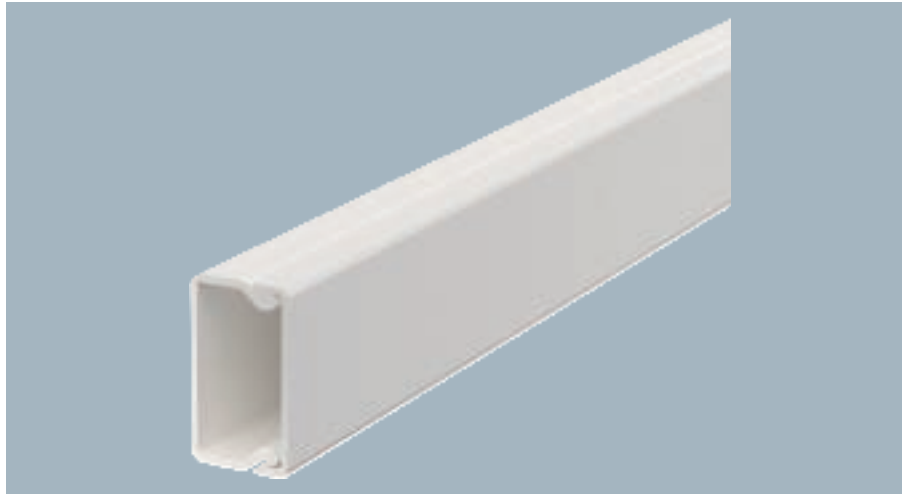

Type	Colour	Length mm	Pack m	Weight kg/100 m	Item no.
WDKH-15030RW	Pure white	2000	48	15.000	6175390
WDKH-15030LGR	Light grey	2000	48	15.000	6175457

Trunking cover and base with base perforation made of halogen-free plastic.

Trunking, type WDKH 15030

PC/
ABS

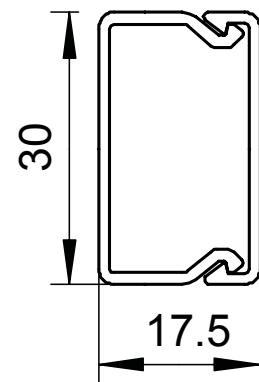
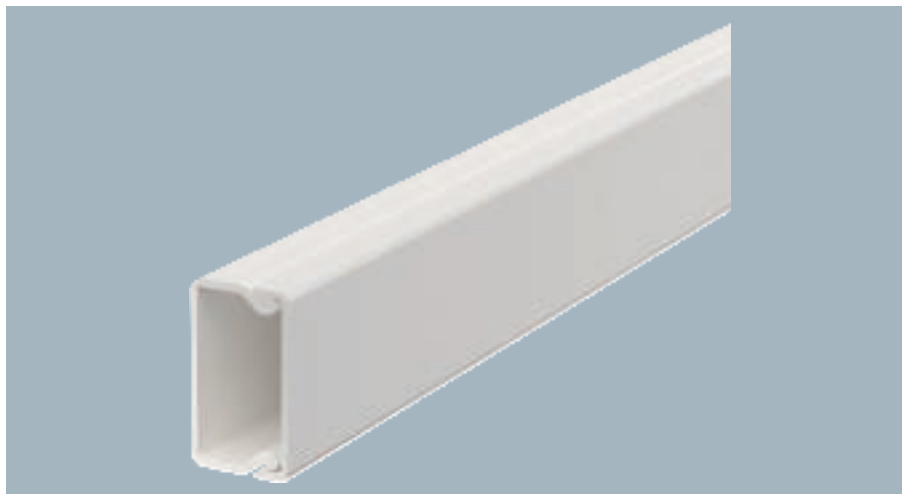

Type	Colour	Length mm	Pack m	Weight kg/100 m	Item no.
WDKH-15030RW T	Pure white	2000	48	16.000	6175392

Trunking cover and base with base perforation made of halogen-free plastic.

Internal corner cover, trunking type WDKH 15030

PC/
ABS

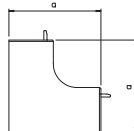

Type	Colour	Dim. mm	Pack Piece	Weight kg/100 pc.	Item no.
WDKH-15030RW	Pure white	38.5	4	0.677	6175578

Internal corner cover for changing the direction of the halogen-free WDKH trunking.

PC/
ABS

External corner cover, trunking type WDKH 15030

Type	Colour	Dim. mm	Pack Piece	Weight kg/100 pc.	Item no.
WDKH-A15030RW	Pure white	38.5	4	0.948	6175618

External corner cover for changing the direction of the halogen-free WDKH trunking.

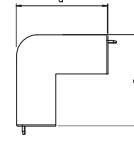

PC/
ABS

Flat angle cover, trunking type WDKH 15030

Type	Colour	Dim. mm	Pack Piece	Weight kg/100 pc.	Item no.
WDKH-F15030RW	Pure white	53	4	0.833	6175654

Flat angle hood for changing the direction of the halogen-free WDKH trunking.

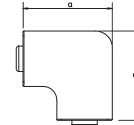

PC/
ABS

T piece cover, for trunking type WDK 15030

Type	Colour	Dim. mm	Dim. b mm	Pack Piece	Weight kg/100 pc.	Item no.
WDKH-T15030RW	Pure white	73	53	4	0.954	6175690

T and intersection cover for changing the direction of the halogen-free WDK-H trunking.

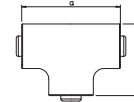

PC/
ABS

End piece, trunking type WDKH 15030

Type	Colour	Dim. mm	Dim. b mm	Pack Piece	Weight kg/100 pc.	Item no.
WDKH-E15030RW	Pure white	30	17	10	0.200	6175546

End piece for closing the WDK-H trunking.

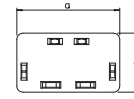

Trunking, type WDKH 20020

PC/
ABS

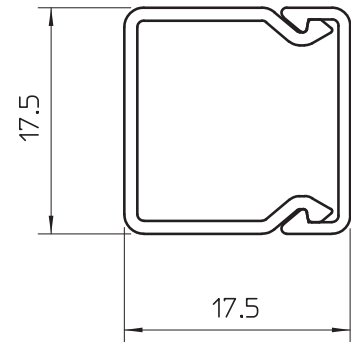

Type	Colour	Length mm	Pack m	Weight kg/100 m	Item no.
WDKH-20020RW	Pure white	2000	48	8.800	6175400
WDKH-20020LGR	Light grey	2000	48	8.800	6175460

Trunking cover and base with base perforation made of halogen-free plastic.

Internal corner cover, trunking type WDKH 20020

PC/
ABS

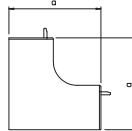

Type	Colour	Dim. mm	Pack Piece	Weight kg/100 pc.	Item no.
WDKH-I20020RW	Pure white	38.5	4	0.540	6175581
WDKH-I20020LGR	Light grey	38.5	4	0.450	6175964

Internal corner cover for changing the direction of the halogen-free WDKH trunking.

External corner cover, trunking type WDKH 20020

PC/
ABS

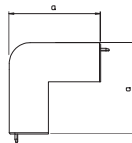

Type	Colour	Dim. mm	Pack Piece	Weight kg/100 pc.	Item no.
WDKH-A20020RW	Pure white	38.5	4	0.578	6175624
WDKH-A20020LGR	Light grey	38.5	4	0.520	6176000

External corner cover for changing the direction of the halogen-free WDKH trunking.

Flat angle cover, trunking type WDKH 20020

PC/
ABS

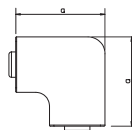

Type	Colour	Dim. mm	Pack Piece	Weight kg/100 pc.	Item no.
WDKH-F20020RW	Pure white	38	4	0.502	6175658
WDKH-F20020LGR	Light grey	38	4	0.502	6176036

Flat angle hood for changing the direction of the halogen-free WDKH trunking.

PC / ABS

T piece cover for trunking type WDKH 20020

Type	Colour	Dim.		Pack Piece	Weight kg/100 pc.	Item no.
		mm	mm			
WDKH-T20020RW	Pure white	57	39	4	0.659	6175694
WDKH-T20020LGR	Light grey	57	39	4	0.659	6176072

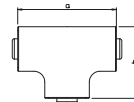

T and intersection cover for changing the direction of the halogen-free WDK-H trunking.

PC / ABS

End piece, trunking type WDKH 20020

Type	Colour	Dim.		Pack Piece	Weight kg/100 pc.	Item no.
		mm	mm			
WDKH-E20020RW	Pure white	19	18	10	0.087	6175550
WDKH-E20020LGR	Light grey	19	18	10	0.089	6175928

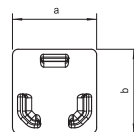

End piece for closing the WDK-H trunking.

Trunking, type WDKH 30045

PC/
ABS

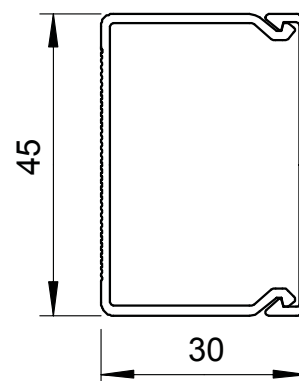
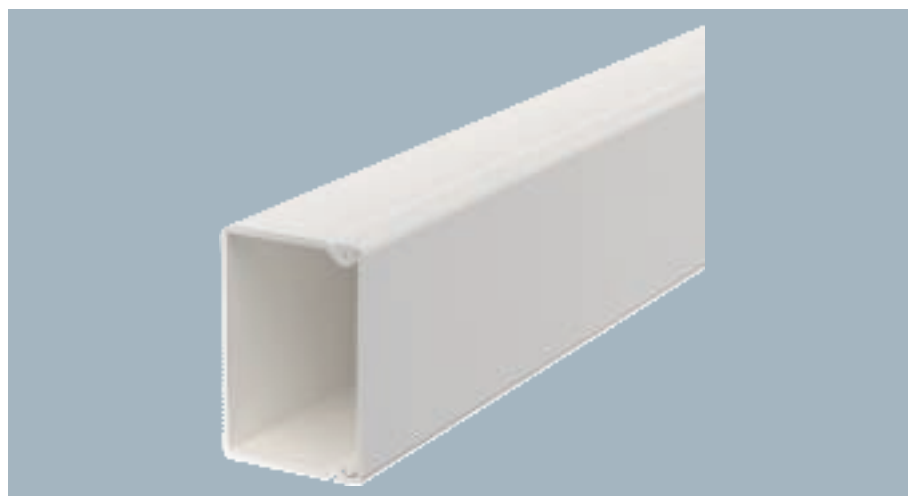

Type	Colour	Length mm	Pack m	Weight kg/100 m	Item no.
WDKH-30045RW	Pure white	2000	48	24.900	6175405
WDKH-30045LGR	Light grey	2000	48	24.900	6175463

Trunking cover and base with base perforation made of halogen-free plastic.

Internal corner cover, trunking type WDKH 30045

PC/
ABS

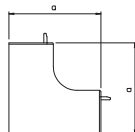

Type	Colour	Dim. mm	Pack Piece	Weight kg/100 pc.	Item no.
WDKH-I30045RW	Pure white	60	4	1.144	6175590
WDKH-I30045LGR	Light grey	60	4	1.144	6175968

Internal corner cover for changing the direction of the halogen-free WDKH trunking.

External corner cover, trunking type WDKH 30045

PC/
ABS

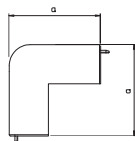

Type	Colour	Dim. mm	Pack Piece	Weight kg/100 pc.	Item no.
WDKH-A30045RW	Pure white	57	4	2.000	6175626
WDKH-A30045LGR	Light grey	57	4	2.000	6176004

External corner cover for changing the direction of the halogen-free WDKH trunking.

Flat angle cover, trunking type WDKH 30045

PC/
ABS

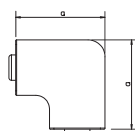

Type	Colour	Dim. mm	Pack Piece	Weight kg/100 pc.	Item no.
WDKH-F30045RW	Pure white	60	4	1.652	6175662
WDKH-F30045LGR	Light grey	60	4	1.652	6176040

Flat angle hood for changing the direction of the halogen-free WDKH trunking.

PC / ABS

T and intersection cover, for trunking type WDK 30045

Type	Colour	Dim. mm	Dim. b mm	Pack Piece	Weight kg/100 pc.	Item no.
WDKH-T30045RW	Pure white	88	68	4	1.803	6175698
WDKH-T30045LGR	Light grey	88	68	4	1.803	6176076

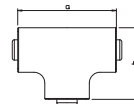

T and intersection cover for changing the direction of the halogen-free WDK-H trunking.

PC / ABS

End piece, trunking type WDKH 30045

Type	Colour	Dim. mm	Dim. b mm	Pack Piece	Weight kg/100 pc.	Item no.
WDKH-E30045RW	Pure white	45	30	10	0.435	6175554
WDKH-E30045LGR	Light grey	45	30	10	0.500	6175932

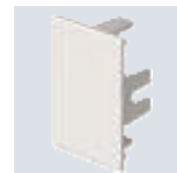
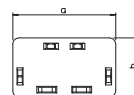

End piece for closing the WDK-H trunking.



Trunking, type WDKH 40060

PC/
ABS

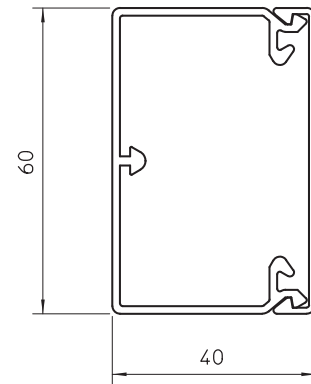
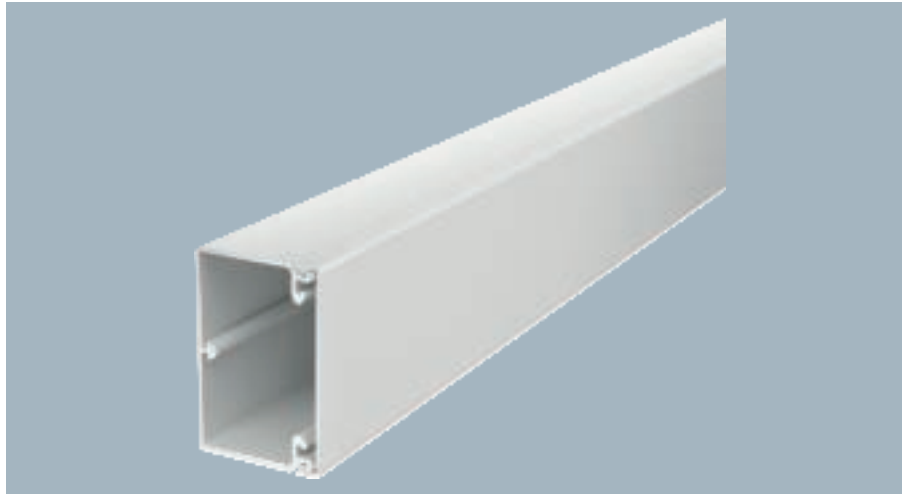

Type	Colour	Length mm	Pack m	Weight kg/100 m	Item no.
WDKH-40060RW	Pure white	2000	32	44.000	6175410
WDKH-40060LGR	Light grey	2000	32	44.000	6175466

Trunking cover and base with base perforation made of halogen-free plastic including cover fixing devices.

Internal corner cover, trunking type WDKH 40060

PC/
ABS

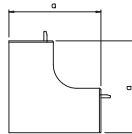

Type	Colour	Dim. mm	Pack Piece	Weight kg/100 pc.	Item no.
WDKH-I40060RW	Pure white	85	2	6.427	6175594
WDKH-I40060LGR	Light grey	85	2	6.427	6175972

Internal corner cover for changing the direction of the halogen-free WDKH trunking.

External corner cover, trunking type WDKH 40060

PC/
ABS

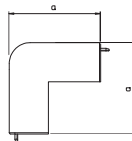

Type	Colour	Dim. mm	Pack Piece	Weight kg/100 pc.	Item no.
WDKH-A40060RW	Pure white	45	2	7.423	6175630
WDKH-A40060LGR	Light grey	45	2	7.423	6176008

External corner cover for changing the direction of the halogen-free WDKH trunking.

Flat angle cover, trunking type WDKH 40060

PC/
ABS

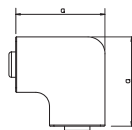

Type	Colour	Dim. mm	Pack Piece	Weight kg/100 pc.	Item no.
WDKH-F40060RW	Pure white	85	2	7.048	6175666
WDKH-F40060LGR	Light grey	85	2	7.048	6176044

Flat angle hood for changing the direction of the halogen-free WDKH trunking.

PC/
ABS

T and intersection cover, for trunking type WDKH 40060

Type	Colour	Dim.		Pack Piece	Weight kg/100 pc.	Item no.
		mm	b mm			
WDKH-T40060RW	Pure white	190	66	2	8.413	6175702
WDKH-T40060LGR	Light grey	190	66	2	8.413	6176080

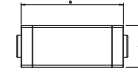

T and intersection cover for changing the direction of the halogen-free WDKH trunking. The fitting is preperforated at the side for the connection of different trunking cross-sections.

PC/
ABS

End piece, trunking type WDKH 40060

Type	Colour	Dim.		Pack Piece	Weight kg/100 pc.	Item no.
		mm	b mm			
WDKH-E40060RW	Pure white	40	60	10	0.992	6175558
WDKH-E40060LGR	Light grey	40	60	10	0.992	6175936

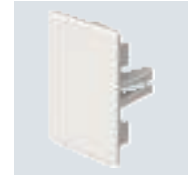
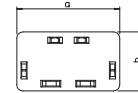

End piece for closing the WDK-H trunking.



Trunking, type WDKH 60090

PC/
ABS

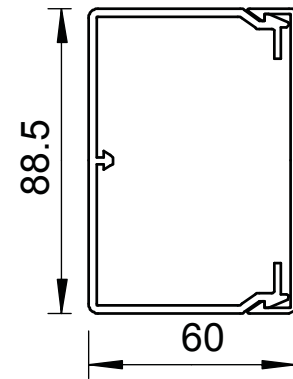

Type	Colour	Length mm	Pack m	Weight kg/100 m	Item no.
WDKH-60090RW	Pure white	2000	24	81.500	6175415
WDKH-60090LGR	Light grey	2000	24	81.500	6175469

Trunking cover and base with base perforation made of halogen-free plastic including cover fixing devices.

Internal corner cover, trunking type WDKH 60090

PC/
ABS

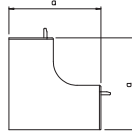

Type	Colour	Dim. mm	Pack Piece	Weight kg/100 pc.	Item no.
WDKH-I60090RW	Pure white	130	2	11.123	6175598
WDKH-I60090LGR	Light grey	130	2	11.123	6175976

Internal corner cover for changing the direction of the halogen-free WDKH trunking.

External corner cover, trunking type WDKH 60090

PC/
ABS

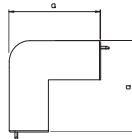

Type	Colour	Dim. mm	Pack Piece	Weight kg/100 pc.	Item no.
WDKH-A60090RW	Pure white	69	2	10.373	6175634
WDKH-A60090LGR	Light grey	69	2	10.700	6176012

External corner cover for changing the direction of the halogen-free WDKH trunking.

Flat angle cover, trunking type WDKH 60090

PC/
ABS

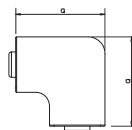

Type	Colour	Dim. mm	Pack Piece	Weight kg/100 pc.	Item no.
WDKH-F60090RW	Pure white	129	2	9.696	6175670
WDKH-F60090LGR	Light grey	129	2	9.696	6176048

Flat angle hood for changing the direction of the halogen-free WDKH trunking.

PC / ABS

T and intersection cover, for trunking type WDKH 60090

Type	Colour	Dim. mm	Pack Piece	Weight kg/100 pc.	Item no.
WDKH-T60090RW	Pure white	230	2	21.500	6175706
WDKH-T60090LGR	Light grey	230	2	21.500	6176084

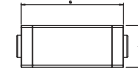

T and intersection cover for changing the direction of the halogen-free WDKH trunking. The fitting is preperforated at the side for the connection of different trunking cross-sections.

PC / ABS

End piece, trunking type WDKH 60090

Type	Colour	Dim. mm	Dim. b mm	Pack Piece	Weight kg/100 pc.	Item no.
WDKH-E60090RW	Pure white	90	60	10	2.024	6175562
WDKH-E60090LGR	Light grey	90	60	10	2.024	6175940

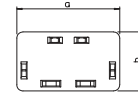

End piece for closing the WDK-H trunking.

Trunking, type WDKH-60110

PC/
ABS

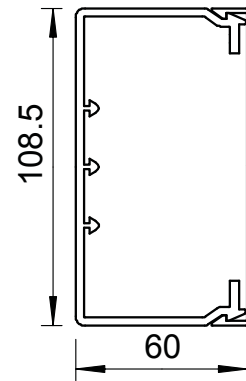

Type	Colour	Length mm	Pack m	Weight kg/100 m	Item no.
WDKH-60110RW	Pure white	2000	16	95.900	6175420
WDKH-60110LGR	Light grey	2000	16	95.900	6175472

Trunking cover and base with base perforation made of halogen-free plastic including cover fixing devices.

Internal corner cover, trunking type WDKH 60110

PC/
ABS

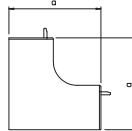

Type	Colour	Dim. mm	Pack Piece	Weight kg/100 pc.	Item no.
WDKH-I60110RW	Pure white	130	2	11.315	6175602
WDKH-I60110LGR	Light grey	130	2	11.315	6175980

Internal corner cover for changing the direction of the halogen-free WDKH trunking.

External corner cover, trunking type WDKH 60110

PC/
ABS

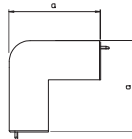

Type	Colour	Dim. mm	Pack Piece	Weight kg/100 pc.	Item no.
WDKH-A60110RW	Pure white	100	2	11.437	6175638
WDKH-A60110LGR	Light grey	100	2	11.338	6176016

External corner cover for changing the direction of the halogen-free WDKH trunking.

Flat angle cover, trunking type WDKH 60110

PC/
ABS

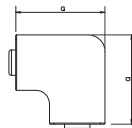

Type	Colour	Dim. mm	Pack Piece	Weight kg/100 pc.	Item no.
WDKH-F60110RW	Pure white	149	2	12.984	6175674
WDKH-F60110LGR	Light grey	149	2	13.022	6176052

Flat angle hood for changing the direction of the halogen-free WDKH trunking.

PC/
ABS

T and intersection cover, for trunking type WDKH 60110

Type	Colour	Dim. mm	Dim. b mm	Pack Piece	Weight kg/100 pc.	Item no.
WDKH-T60110RW	Pure white	272	114	2	20.921	6175710
WDKH-T60110LGR	Light grey	272	114	2	20.921	6176088

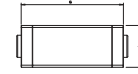

T and intersection cover for changing the direction of the halogen-free WDKH trunking. The fitting is preperforated at the side for the connection of different trunking cross-sections.

PC/
ABS

End piece, trunking type WDKH 60110

Type	Colour	Dim. mm	Dim. b mm	Pack Piece	Weight kg/100 pc.	Item no.
WDKH-E60110RW	Pure white	110	60	10	2.556	6175566
WDKH-E60110LGR	Light grey	110	60	10	2.528	6175944

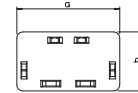

End piece for closing the WDK-H trunking.



Trunking, type WDKH 60150

PC/
ABS

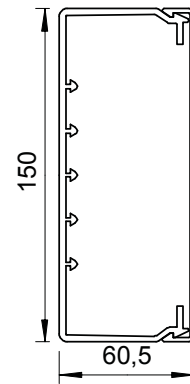

Type	Colour	Length mm	Pack m	Weight kg/100 m	Item no.
WDKH-60150RW	Pure white	2000	8	146.650	6175425
WDKH-60150LGR	Light grey	2000	8	146.650	6175475

Trunking cover and base with base perforation made of halogen-free plastic including cover fixing devices.

Internal corner cover, trunking type WDKH 60150

PC/
ABS

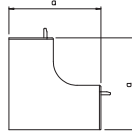

Type	Colour	Dim. mm	Pack Piece	Weight kg/100 pc.	Item no.
WDKH-I60150RW	Pure white	130	2	12.521	6175606
WDKH-I60150LGR	Light grey	130	2	12.521	6175984

Internal corner cover for changing the direction of the halogen-free WDKH trunking.

External corner cover, trunking type WDKH 60150

PC/
ABS

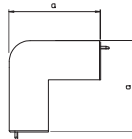

Type	Colour	Dim. mm	Pack Piece	Weight kg/100 pc.	Item no.
WDKH-A60150RW	Pure white	100	2	15.180	6175642
WDKH-A60150LGR	Light grey	100	2	15.180	6176020

External corner cover for changing the direction of the halogen-free WDKH trunking.

Flat angle cover, trunking type WDKH 60150

PC/
ABS

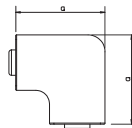

Type	Colour	Dim. mm	Pack Piece	Weight kg/100 pc.	Item no.
WDKH-F60150RW	Pure white	190	2	18.643	6175678
WDKH-F60150LGR	Light grey	190	2	18.643	6176056

Flat angle hood for changing the direction of the halogen-free WDKH trunking.

PC/
ABS

T and intersection cover, for trunking type WDKH 60150

Type	Colour	Dim. mm	Dim. b mm	Pack Piece	Weight kg/100 pc.	Item no.
WDKH-T60150RW	Pure white	291	155	2	23.463	6175714
WDKH-T60150LGR	Light grey	291	155	2	23.463	6176092

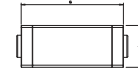

T and intersection cover for changing the direction of the halogen-free WDKH trunking. The fitting is preperforated at the side for the connection of different trunking cross-sections.

PC/
ABS

End piece, trunking type WDKH 60150

Type	Colour	Dim. mm	Dim. b mm	Pack Piece	Weight kg/100 pc.	Item no.
WDKH-E60150RW	Pure white	150	60	10	3.613	6175570
WDKH-E60150LGR	Light grey	150	60	10	3.736	6175948

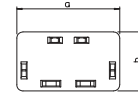

End piece for closing the WDK-H trunking.

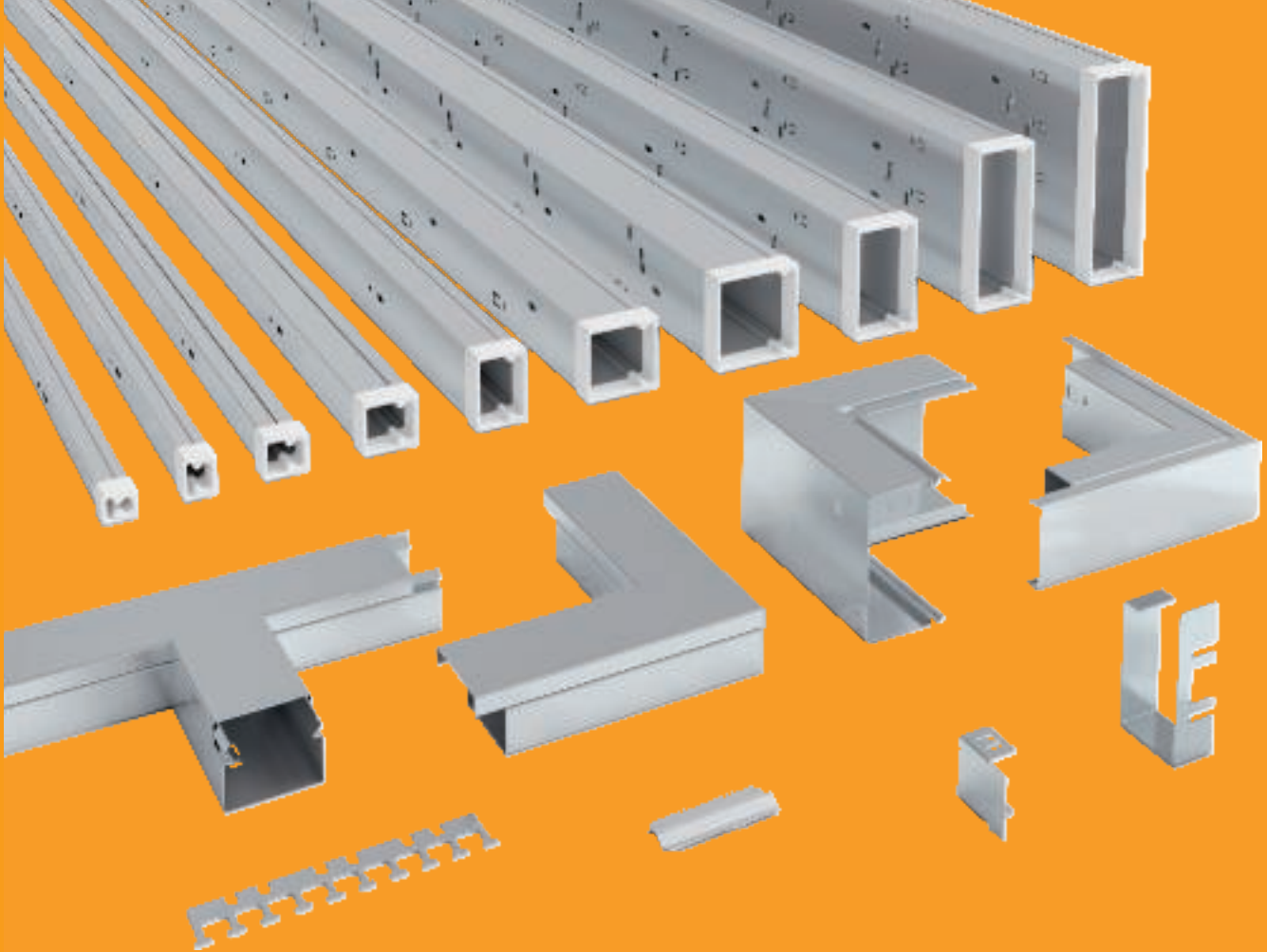

Reliable protection for cables

LKM cable ducts, metal

A wide range of practical mounting details make the LKM cable ducts a reliable partner during cable routing.



Partition



Duct clamp



Secure equipotential bonding



Cable brackets



Edge protection

LKM cable ducts, metal

Installation principle

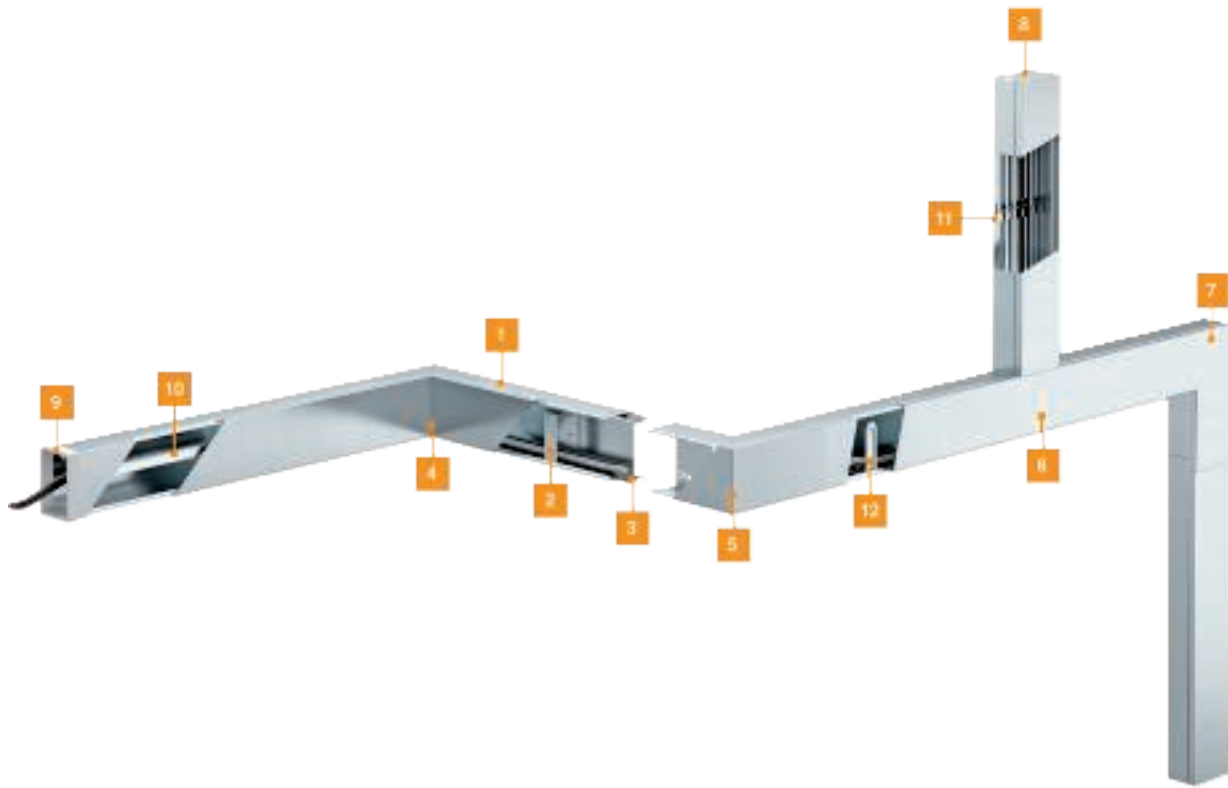

1	Trunking	LKM
2	Duct clamp for the maintenance of electrical function	LKM KF
3	Joint connector	LKM SV
4	Internal corner	LKM I
5	External corner	LKM A
6	T piece	LKM T
7	Flat angle	LKM F
8	End piece	LKM E
9	Edge protection ring	KSR
10	Partition	LKM TWS
11	Cable brackets	LKM Z
12	Duct clamp	LKM KF

Maintenance of electrical function LKM cable routing ducts



Horizontal wall and ceiling mounting.



Routing of power, data or fire alarm cables in the duct, type LKM60100.



Tidy routing of data and fire alarm cables in the duct, type 20030.



Retaining clamps locked into the base as installation aid for wall mounting.



Retaining clamps as mounting aid for the insertion of cables for ceiling mounting.



S30

S60

S90

Cable routing with metal cable ducts, type LKM, is approved as a cable-specific routing type for the maintenance of electrical function classes E 30, E 60 and E 90 according to DIN 4102 Part 12. The ducts may be routed horizontally on the wall or under the ceiling and offer additional mechanical protection of the installed cables. This installation variant is also used if, for reasons of appearance, open routing of the cables with the maintenance of electrical function is not wanted. A retaining clamp is available as an installation aid for the duct type LKM60100. This prevents cables from falling out in the case of wall and ceiling mounting. When cable installation has been completed, the duct cover is locked onto the duct base.

St FS

Cable trunking, type LKM 20020

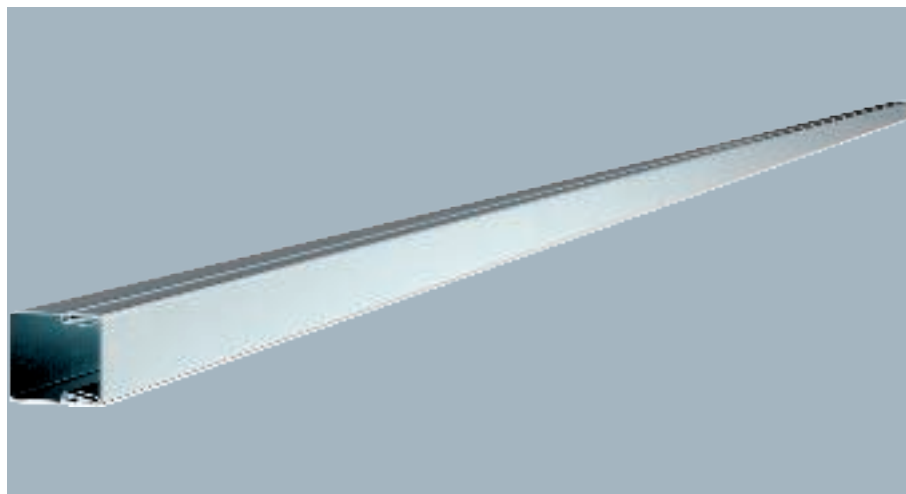
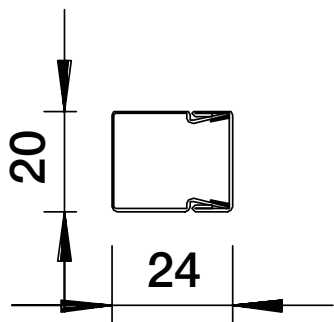

Duct cover and base with base perforation. Equipotential bonding is guaranteed between the cover and the base without any additional aids.

Type	Length mm	Pack m	Weight kg/100 m	Item no.
LKM20020FS	2000	32	46.000	6246966

St FSK

Cable trunking, type LKM 20020

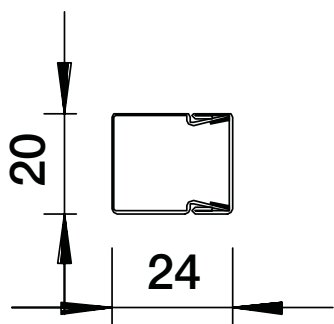

Duct cover and base with base perforation. Equipotential bonding is guaranteed between the cover and the base without any additional aids.

Type	Length mm	Pack m	Weight kg/100 m	Item no.
LKM20020RW	2000	30	52.000	6248462

VA 2B

Joint connector LKM SV20

Type	Dim. mm	Dim. b mm	Pack Piece	Weight kg/100 pc.	Item no.
LKM SV20	45	20	10	0.190	6247431

Joint connector to connect the bases. This creates the equipotential bonding between the trunking bases.

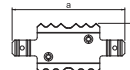

Trunking height 24 mm, trunking width 20 mm

PVC

Edge protection ring KSR 20020, for LKM cable trunking type 20020

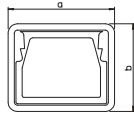

Type	Colour	Dim.		Pack Piece	Weight kg/100 pc.	Item no.
		mm	mm			
KSR20020	Grey	24	28	5	0.900	6249842

Edge protection ring for the open ends of LKM cable trunking.



St FS

Cable trunking, type LKM 20030

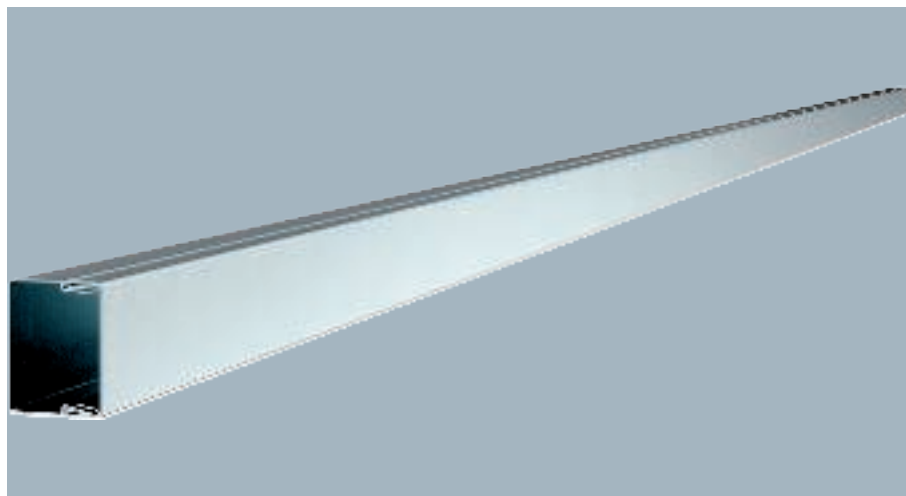
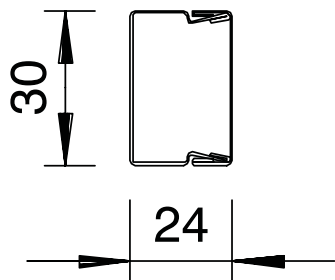

Trunking cover and base with base perforation. Equipotential bonding is guaranteed between the cover and the base without any additional aids. The LKM cable trunking, type LKM 20030FS, has been tested for the maintenance of electrical function as a routing system according to DIN 4102 Part 12. Please note the cable types tested in the BSS fire protection systems division!

Type	Colour	Length mm	Pack m	Weight kg/100 m	Item no.
LKM20030FS	—	2000	24	58.000	6246974

St FSK

Cable trunking, type LKM 20030

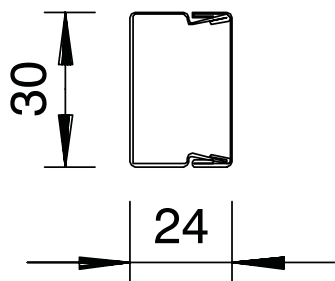

Trunking cover and base with base perforation. Equipotential bonding is guaranteed between the cover and the base without any additional aids. The LKM cable trunking, type LKM 20030FS, has been tested for the maintenance of electrical function as a routing system according to DIN 4102 Part 12. Please note the cable types tested in the BSS fire protection systems division!

Type	Colour	Length mm	Pack m	Weight kg/100 m	Item no.
LKM20030RW	Pure white	2000	28	58.000	6248470

VA 2B

Joint connector LKM SV30

Type	Dim. mm	Dim. b mm	Pack Piece	Weight kg/100 pc.	Item no.
LKM SV30	54	30	10	0.400	6247434

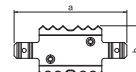

Joint connector to connect the bases. This creates the equipotential bonding between the duct bases.

Trunking height 24 mm, trunking width 30 mm

PVC

Edge protection ring KSR 20030, for LKM cable trunking type 20030

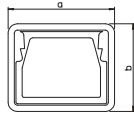

Type	Colour	Dim.		Pack Piece	Weight kg/100 pc.	Item no.
		mm	mm			
KSR20030	Grey	34	28	5	1.100	6249844

Edge protection ring for the open ends of LKM cable trunking.



St FS

Cable routing trunking, type LKM 30030

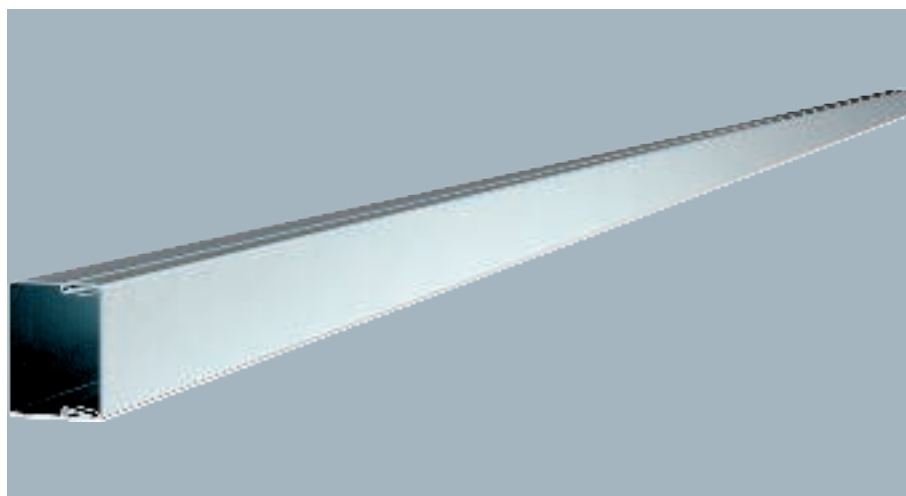
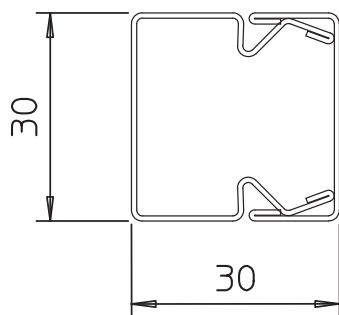

Trunking cover and base with base perforation. Equipotential bonding is guaranteed between the cover and the base without any additional aids.

Type	Colour	Length mm	Pack m	Weight kg/100 m	Item no.
LKM30030FS	—	2000	16	62.000	6246985

St FSK

Cable routing trunking, type LKM 30030

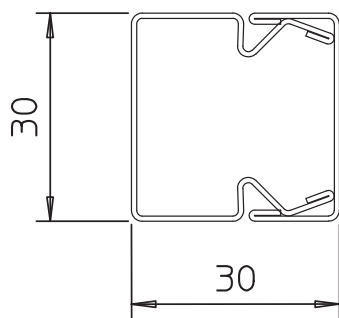

Trunking cover and base with base perforation. Equipotential bonding is guaranteed between the cover and the base without any additional aids.

Type	Colour	Length mm	Pack m	Weight kg/100 m	Item no.
LKM30030RW	Pure white	2000	16	62.000	6248489

VA 2B

Joint connector LKM SV30

Type	Dim. mm	Dim. b mm	Pack Piece	Weight kg/100 pc.	Item no.
LKM SV30	54	30	10	0.400	6247434

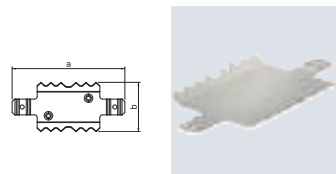

Joint connector to connect the bases. This creates the equipotential bonding between the duct bases.

Trunking height 30 mm, trunking width 30 mm

PVC

Edge protection ring KSR 30030, for LKM cable trunking 30030

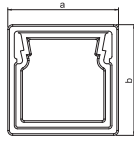

Type	Colour	Dim.		Pack Piece	Weight kg/100 pc.	Item no.
		mm	mm			
KSR30030	Grey	34	34	5	1.300	6249847

Edge protection ring for the open ends of LKM cable trunking.



St FS

Cable trunking, type LKM 40040

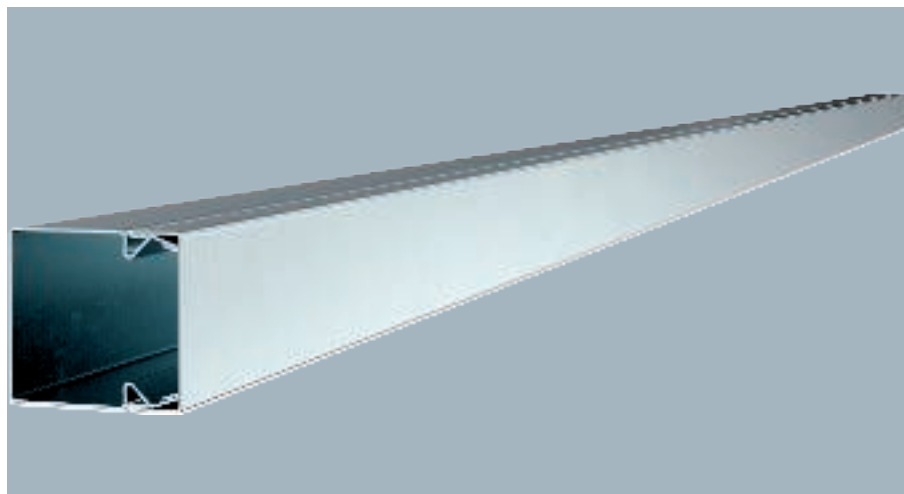
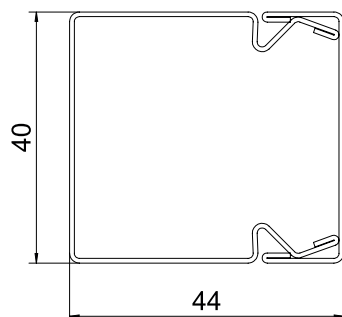

Trunking cover and base with base perforation. Equipotential bonding is guaranteed between the cover and the base without any additional aids.

Type	Colour	Length mm	Pack m	Weight kg/100 m	Item no.
LKM40040FS	–	2000	16	117.000	6246990

St FSK

Cable trunking, type LKM 40040

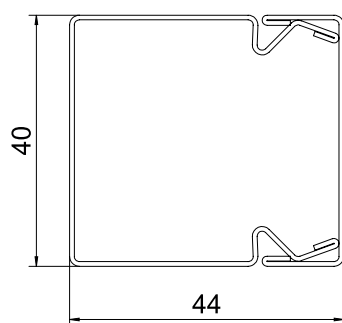

Trunking cover and base with base perforation. Equipotential bonding is guaranteed between the cover and the base without any additional aids.

Type	Colour	Length mm	Pack m	Weight kg/100 m	Item no.
LKM40040RW	Pure white	2000	12	127.600	6248497

VA 2B

Joint connector LKM SV40

Type	Dim. mm	Dim. b mm	Pack Piece	Weight kg/100 pc.	Item no.
LKM SV40	76	30	10	1.000	6247458

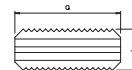

Joint connector to connect the bases. This creates the equipotential bonding between the duct bases.

Trunking height 40 mm, trunking width 40 mm

Internal corner, for cable trunking type LKM 40040

St FS

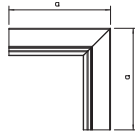
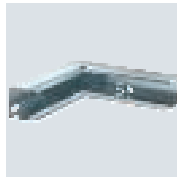

Type	Colour	Dim. mm	Pack Piece	Weight kg/100 pc.	Item no.
LKM I40040FS	–	160	1	28.000	6247652

Internal corner for changing the direction of the LKM ducts.

Internal corner, for cable trunking type LKM 40040

St FSK

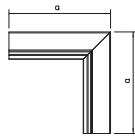
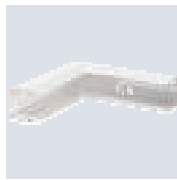

Type	Colour	Dim. mm	Pack Piece	Weight kg/100 pc.	Item no.
LKM I40040RW	Pure white	160	1	28.000	6249167

Internal corner for changing the direction of the LKM ducts.

External corner, for cable trunking ducts type LKM 40040

St FS

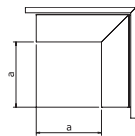

Type	Colour	Dim. mm	Pack Piece	Weight kg/100 pc.	Item no.
LKM A40040FS	–	120	1	38.600	6247563

External corner including cover for changing the direction of the LKM trunking.

External corner, for cable trunking ducts type LKM 40040

St FSK

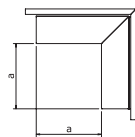

Type	Colour	Dim. mm	Pack Piece	Weight kg/100 pc.	Item no.
LKM A40040RW	Pure white	120	1	38.600	6249086

External corner including cover for changing the direction of the LKM trunking.

T piece, for cable trunking type LKM 40040

St FS

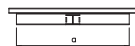

Type	Colour	Dim. mm	Pack Piece	Weight kg/100 pc.	Item no.
LKM T40040FS	–	300	1	39.700	6247725

T piece including cover for changing the direction of the LKM ducts.

St FSK

T piece, for cable trunking type LKM 40040

Type	Colour	Dim. mm	Pack Piece	Weight kg/100 pc.	Item no.
LKM T40040RW	Pure white	300	1	39.700	6249256

T piece including cover for changing the direction of the LKM ducts.

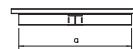

St FS

Flat angle, for cable trunking type LKM 40040

Type	Colour	Dim. mm	Pack Piece	Weight kg/100 pc.	Item no.
LKM F40040FS	—	140	1	37.100	6247490

Flat angle including cover for changing the direction of the LKM ducts.

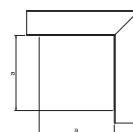

St FSK

Flat angle, for cable trunking type LKM 40040

Type	Colour	Dim. mm	Pack Piece	Weight kg/100 pc.	Item no.
LKM F40040RW	Pure white	140	1	37.100	6248993

Flat angle including cover for changing the direction of the LKM ducts.

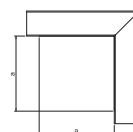

St FS

End piece, for cable trunking type LKM 40040

Type	Colour	Dim. mm	Dim. b mm	Pack Piece	Weight kg/100 pc.	Item no.
LKM E40040FS	—	40	44	10	2.500	6247881

End piece for closing the LKM ducts.

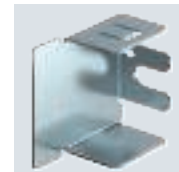
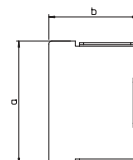

St FSK

End piece, for cable trunking type LKM 40040

Type	Colour	Dim. mm	Dim. b mm	Pack Piece	Weight kg/100 pc.	Item no.
LKM E40040RW	Pure white	40	44	10	2.500	6249418

End piece for closing the LKM ducts.

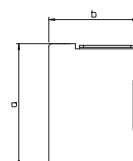

Trunking height 40 mm, trunking width 40 mm

PVC

Edge protection ring KSR40040, for LKM cable trunking type 40040

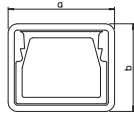

Type	Colour	Dim.		Pack Piece	Weight kg/100 pc.	Item no.
		mm	mm			
KSR40040	Grey	44	48	5	1.800	6249846

Edge protection ring for the open ends of LKM cable trunking.



St FS

Cable trunking, type LKM 40060

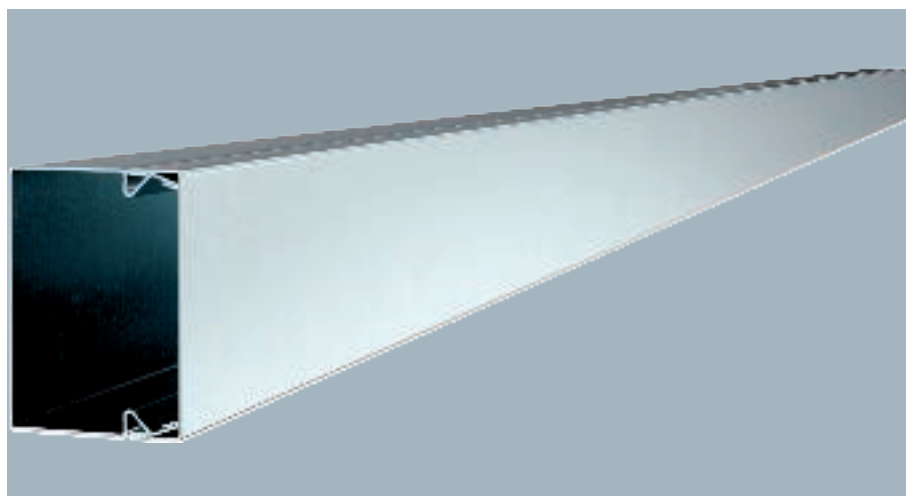
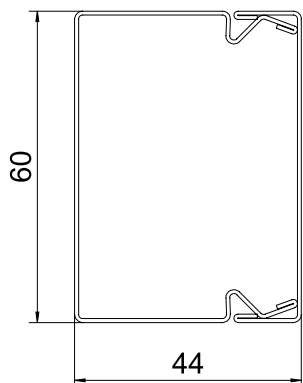

Trunking cover and base with base perforation. Equipotential bonding is guaranteed between the cover and the base without any additional aids.

Type	Colour	Length mm	Pack m	Weight kg/100 m	Item no.
LKM40060FS	–	2000	8	151.200	6247016

St FSK

Cable trunking, type LKM 40060

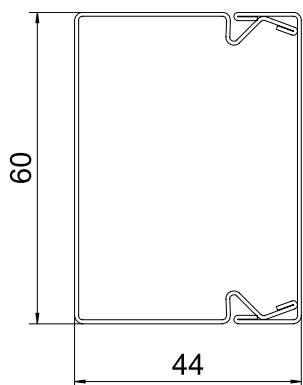

Trunking cover and base with base perforation. Equipotential bonding is guaranteed between the cover and the base without any additional aids.

Type	Colour	Length mm	Pack m	Weight kg/100 m	Item no.
LKM40060RW	Pure white	2000	8	151.200	6248519

VA 2B

Joint connector LKM SV40

Type	Dim. mm	Dim. b mm	Pack Piece	Weight kg/100 pc.	Item no.
LKM SV40	76	30	10	1.000	6247458

Joint connector to connect the bases. This creates the equipotential bonding between the duct bases.

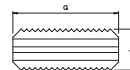

Trunking height 40 mm, trunking width 60 mm

Internal corner, for cable trunking type LKM 40060

St FS

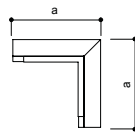
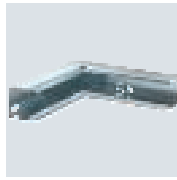

Type	Colour	Dim. mm	Pack Piece	Weight kg/100 pc.	Item no.
LKM I40060FS	–	160	1	31.400	6247660

Internal corner for changing the direction of LKM ducts.

Internal corner, for cable trunking type LKM 40060

St FSK

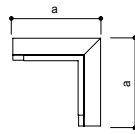
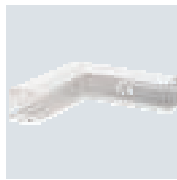

Type	Colour	Dim. mm	Pack Piece	Weight kg/100 pc.	Item no.
LKM I40060RW	Pure white	160	1	31.400	6249175

Internal corner for changing the direction of LKM ducts.

External corner, for cable routing duct type LKM 40060

St FS

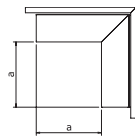

Type	Colour	Dim. mm	Pack Piece	Weight kg/100 pc.	Item no.
LKM A40060FS	–	120	1	46.300	6247571

External corner including cover for changing the direction of the LKM ducts.

External corner, for cable routing duct, type LKM 40060

St FSK

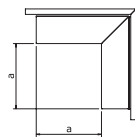

Type	Colour	Dim. mm	Pack Piece	Weight kg/100 pc.	Item no.
LKM A40060RW	Pure white	120	1	46.300	6249094

External corner including cover for changing the direction of the LKM ducts.

T piece, for cable trunking type LKM 40060

St FS

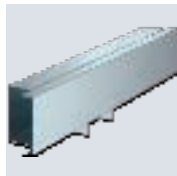

Type	Colour	Dim. mm	Pack Piece	Weight kg/100 pc.	Item no.
LKM T40060FS	–	300	1	46.800	6247733

T piece including cover for changing the direction of the LKM ducts.

St FSK

T piece, for cable trunking type LKM 40060

Type	Colour	Dim. mm	Pack Piece	Weight kg/100 pc.	Item no.
LKM T40060RW	Pure white	300	1	46.800	6249264

T piece including cover for changing the direction of the LKM ducts.



St FS

Flat angle, for cable trunking type LKM 40060

Type	Colour	Dim. mm	Pack Piece	Weight kg/100 pc.	Item no.
LKM F40060FS	—	140	1	47.400	6247504

Flat angle including cover for changing the direction of the LKM ducts.

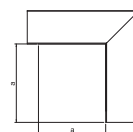

St FSK

Flat angle, for cable trunking type LKM 40060

Type	Colour	Dim. mm	Pack Piece	Weight kg/100 pc.	Item no.
LKM F40060RW	Pure white	140	1	47.400	6249000

Flat angle including cover for changing the direction of the LKM ducts.

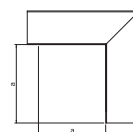

St FS

End piece, for cable trunking type LKM 40060

Type	Colour	Dim. mm	Dim. b mm	Pack Piece	Weight kg/100 pc.	Item no.
LKM E40060FS	—	60	44	10	3.000	6247903

End piece for closing the LKM ducts.

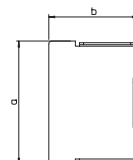

St FSK

End piece, for cable trunking type LKM 40060

Type	Colour	Dim. mm	Dim. b mm	Pack Piece	Weight kg/100 pc.	Item no.
LKM E40060RW	Pure white	60	44	10	3.000	6249426

End piece for closing the LKM ducts.

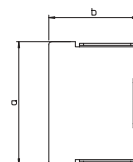

Trunking height 40 mm, trunking width 60 mm

PVC

Edge protection ring KSR40060, for LKM cable trunking type 40060

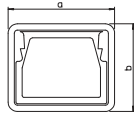

Type	Colour	Dim.		Pack Piece	Weight kg/100 pc.	Item no.
		Dim. mm	b mm			
KSR40060	Grey	64	48	5	2.300	6249848

Edge protection ring for the open ends of LKM cable trunking.



St FS

Cable trunking, type LKM 60060

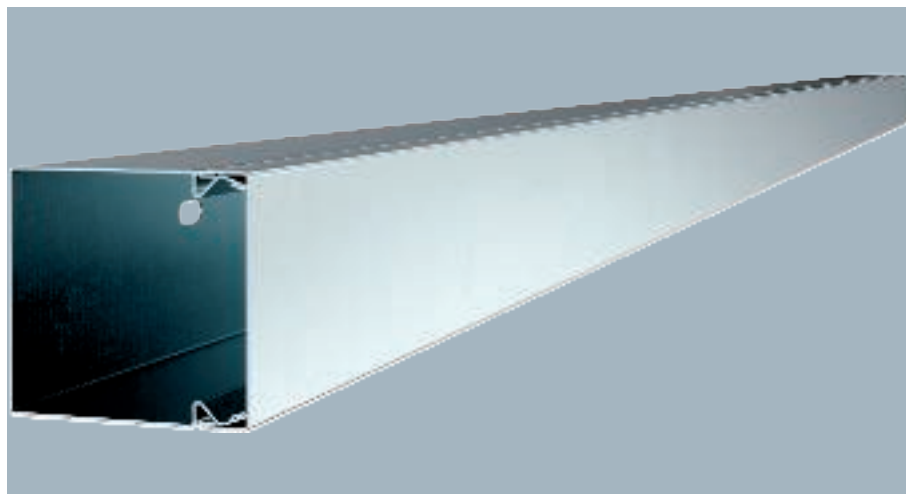
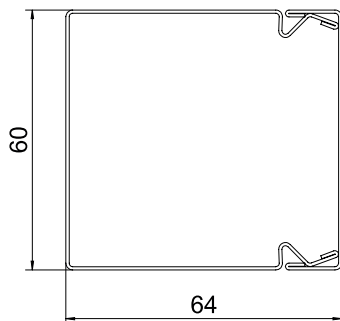

Trunking cover and base with base perforation. Equipotential bonding is guaranteed between the cover and the base without any additional aids. Note: LKM 60060 has no loop perforation in the base, a partition cannot be installed.

Type	Colour	Length mm	Pack m	Weight kg/100 m	Item no.
LKM60060FS	–	2000	8	174.700	6247091

St FSK

Cable trunking, type LKM 60060

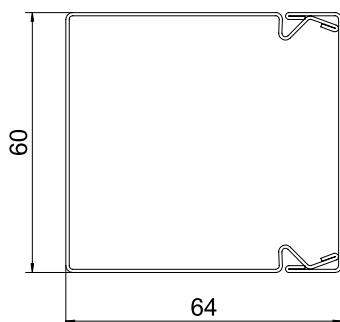

Trunking cover and base with base perforation. Equipotential bonding is guaranteed between the cover and the base without any additional aids. Note: LKM 60060 has no loop perforation in the base, a partition cannot be installed.

Type	Colour	Length mm	Pack m	Weight kg/100 m	Item no.
LKM60060RW	Pure white	2000	8	174.700	6248608

VA 2B

Joint connector LKM SV60

Type	Dim. mm	Dim. b mm	Pack Piece	Weight kg/100 pc.	Item no.
LKM SV60	75	49	10	1.600	6247466

Joint connector to connect the bases. This creates the equipotential bonding between the duct bases.

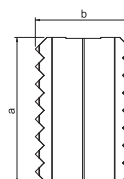

Trunking height 60 mm, trunking width 60 mm

Internal corner, for cable trunking type LKM 60060

St FS

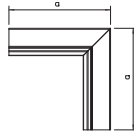

Type	Colour	Dim. mm	Pack Piece	Weight kg/100 pc.	Item no.
LKM I60060FS	–	160	1	31.900	6248128

Internal corner for changing the direction of the LKM trunking.

Internal corner, for cable trunking type LKM 60060

St FSK

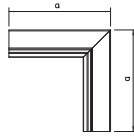

Type	Colour	Dim. mm	Pack Piece	Weight kg/100 pc.	Item no.
LKM I60060RW	Pure white	160	1	31.900	6249612

Internal corner for changing the direction of the LKM trunking.

External corner, for cable trunking type LKM 60060

St FS

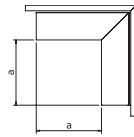

Type	Colour	Dim. mm	Pack Piece	Weight kg/100 pc.	Item no.
LKM A60060FS	–	120	1	55.800	6248047

External corner including cover for changing the direction of the LKM ducts.

External corner, for cable trunking type LKM 60060

St FSK

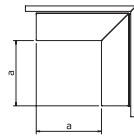

Type	Colour	Dim. mm	Pack Piece	Weight kg/100 pc.	Item no.
LKM A60060RW	Pure white	120	1	55.800	6249558

External corner including cover for changing the direction of the LKM ducts.

T piece, for cable routing duct type LKM 60060

St FS

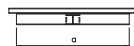

Type	Colour	Dim. mm	Pack Piece	Weight kg/100 pc.	Item no.
LKM T60060FS	–	300	1	54.200	6248187

T piece including cover for changing the direction of the LKM trunking.

St FSK

T piece, for cable trunking type LKM 60060

Type	Colour	Dim. mm	Pack Piece	Weight kg/100 pc.	Item no.
LKM T60060RW	Pure white	300	1	54.200	6249671

T piece including cover for changing the direction of the LKM trunking.

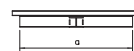

St FS

Flat angle, for cable trunking type LKM 60060

Type	Colour	Dim. mm	Pack Piece	Weight kg/100 pc.	Item no.
LKM F60060FS	–	140	1	54.700	6247989

Flat angle including cover for changing the direction of the LKM ducts.

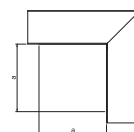

St FSK

Flat angle, for cable trunking type LKM 60060

Type	Colour	Dim. mm	Pack Piece	Weight kg/100 pc.	Item no.
LKM F60060RW	Pure white	140	1	54.700	6249485

Flat angle including cover for changing the direction of the LKM ducts.

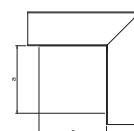

St FS

End piece, for cable trunking type LKM 60060

Type	Colour	Dim. mm	Dim. b mm	Pack Piece	Weight kg/100 pc.	Item no.
LKM E60060FS	–	60	64	10	4.500	6248284

End piece for closing the LKM ducts.

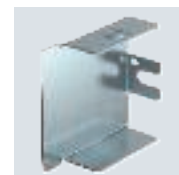
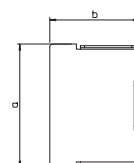

St FSK

End piece, for cable trunking type LKM 60060

Type	Colour	Dim. mm	Dim. b mm	Pack Piece	Weight kg/100 pc.	Item no.
LKM E60060RW	Pure white	60	64	10	4.500	6249795

End piece for closing the LKM ducts.

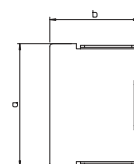

Trunking height 60 mm, trunking width 60 mm

PVC

Edge protection ring KSR60060, for LKM cable trunking type 60060

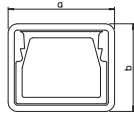

Type	Colour	Dim.		Pack Piece	Weight kg/100 pc.	Item no.
		mm	mm			
KSR60060	Grey	64	68	5	2.400	6249850

Edge protection ring for the open ends of LKM cable duct.



St FS

Cable trunking, type LKM 60100

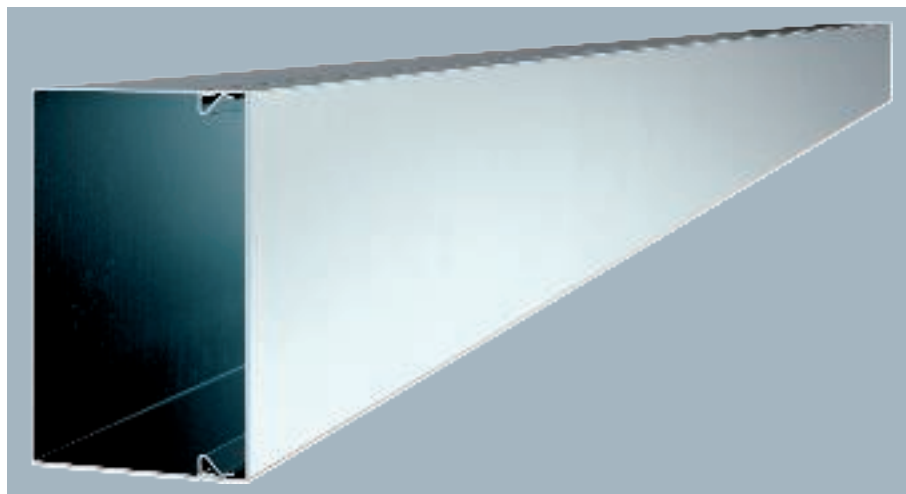
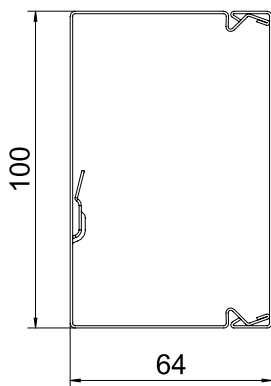

Trunking cover and base with base perforation. Equipotential bonding is guaranteed between the cover and the base without any additional aids. The LKM cable trunking, type LKM 60100FS, has been tested for the maintenance of electrical function as a routing system according to DIN 4102 Part 12. Please note the cable types tested in the BSS fire protection systems division!

Type	Colour	Length mm	Pack m	Weight kg/100 m	Item no.
LKM60100FS	–	2000	8	221.700	6247113

St FSK

Cable trunking, type LKM 60100

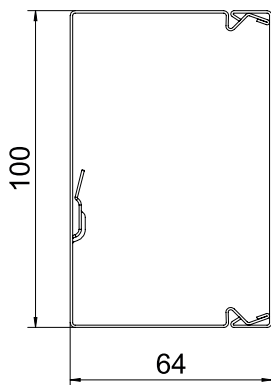

Trunking cover and base with base perforation. Equipotential bonding is guaranteed between the cover and the base without any additional aids. The LKM cable trunking, type LKM 60100FS, has been tested for the maintenance of electrical function as a routing system according to DIN 4102 Part 12. Please note the cable types tested in the BSS fire protection systems division!

Type	Colour	Length mm	Pack m	Weight kg/100 m	Item no.
LKM60100RW	Pure white	2000	8	221.700	6248624

St FS

Duct clamp, LKM, for maintenance of electrical function E30 - E90

Type	Pack Piece	Weight kg/100 pc.	Item no.
LKM KF 60100	10	9.800	6249881

Duct clamp for the metal cable routing duct type LKM 60100FS, prevents the cables falling out during installation. The duct clamp is essential if the duct is used in cable systems with integrated maintenance of electrical function to DIN 4102, Part 12. Easy mounting through insertion into the loop perforation in the side wall.

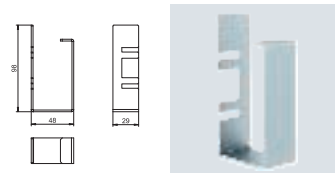

Joint connector LKM SV60

VA 2B

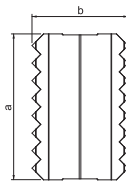

Type	Dim.		Pack Piece	Weight kg/100 pc.	Item no.
	mm	mm			
LKM SV60	75	49	10	1.600	6247466

Joint connector to connect the bases. This creates the equipotential bonding between the duct bases.

Internal corner, for cable duct type LKM 60100

St FS

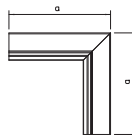
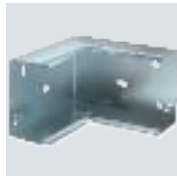

Type	Colour	Dim.	Pack Piece	Weight kg/100 pc.	Item no.
		mm			
LKM I60100FS	-	160	1	39.400	6248144

Internal corner for changing the direction of the LKM trunking.

Internal corner, for cable duct type LKM 60100

St FSK

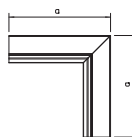

Type	Colour	Dim.	Pack Piece	Weight kg/100 pc.	Item no.
		mm			
LKM I60100RW	Pure white	160	1	39.400	6249639

Internal corner for changing the direction of the LKM trunking.

External corner, for cable duct type LKM 60100

St FS

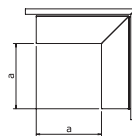

Type	Colour	Dim.	Pack Piece	Weight kg/100 pc.	Item no.
		mm			
LKM A60100FS	-	120	1	73.100	6248063

External corner including cover for changing the direction of the LKM ducts.

External corner, for cable duct type LKM 60100

St FSK

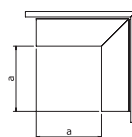

Type	Colour	Dim.	Pack Piece	Weight kg/100 pc.	Item no.
		mm			
LKM A60100RW	Pure white	120	1	73.100	6249574

External corner including cover for changing the direction of the LKM ducts.

St FS

T piece for cable routing duct type LKM 60100

Type	Colour	Dim. mm	Pack Piece	Weight kg/100 pc.	Item no.
LKM T60100FS	–	300	1	69.200	6248209

T piece including cover for changing the direction of the LKM ducts.

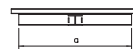

St FSK

T piece for cable routing duct type LKM 60100

Type	Colour	Dim. mm	Pack Piece	Weight kg/100 pc.	Item no.
LKM T60100RW	Pure white	300	1	69.200	6249701

T piece including cover for changing the direction of the LKM ducts.

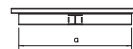

St FS

Flat angle, for cable duct type LKM 60100

Type	Colour	Dim. mm	Pack Piece	Weight kg/100 pc.	Item no.
LKM F60100FS	–	140	1	63.400	6248004

Flat angle including cover for changing the direction of the LKM ducts.

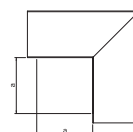

St FSK

Flat angle, for cable duct type LKM 60100

Type	Colour	Dim. mm	Pack Piece	Weight kg/100 pc.	Item no.
LKM F60100RW	Pure white	140	1	63.400	6249507

Flat angle including cover for changing the direction of the LKM ducts.

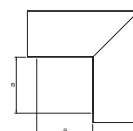

St FS

End piece, for cable duct type LKM 60100

Type	Colour	Dim. mm	Dim. b mm	Pack Piece	Weight kg/100 pc.	Item no.
LKM E60100FS	–	100	64	10	6.200	6248306

End piece for closing the LKM ducts.

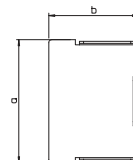

End piece, for cable duct type LKM 60100

St FSK

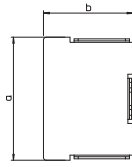

Type	Colour	Dim.		Pack Piece	Weight kg/100 pc.	Item no.
		mm	mm			
LKM E60100RW	Pure white	100	64	10	6.500	6249817

End piece for closing the LKM ducts.

Edge protection ring KSR60100, for LKM cable trunking type 60100

PVC

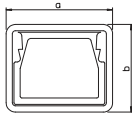

Type	Colour	Dim.		Pack Piece	Weight kg/100 pc.	Item no.
		mm	mm			
KSR60100	Grey	104	68	5	3.400	6249852

Edge protection ring for the open ends of LKM cable trunking.



St FS

Cable trunking, type LKM 60150

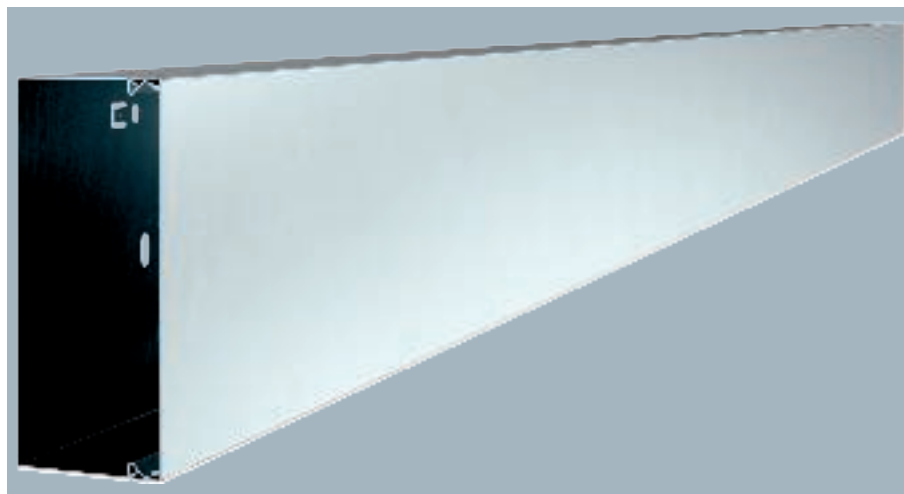
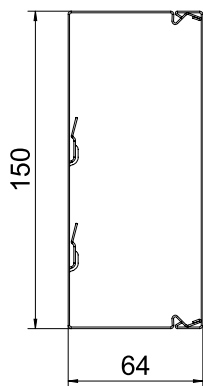

Trunking cover and base with base perforation. Equipotential bonding is guaranteed between the cover and the base without any additional aids.

Type	Colour	Length mm	Pack m	Weight kg/100 m	Item no.
LKM60150FS	–	2000	8	280.100	6247148

St FSK

Cable trunking, type LKM 60150

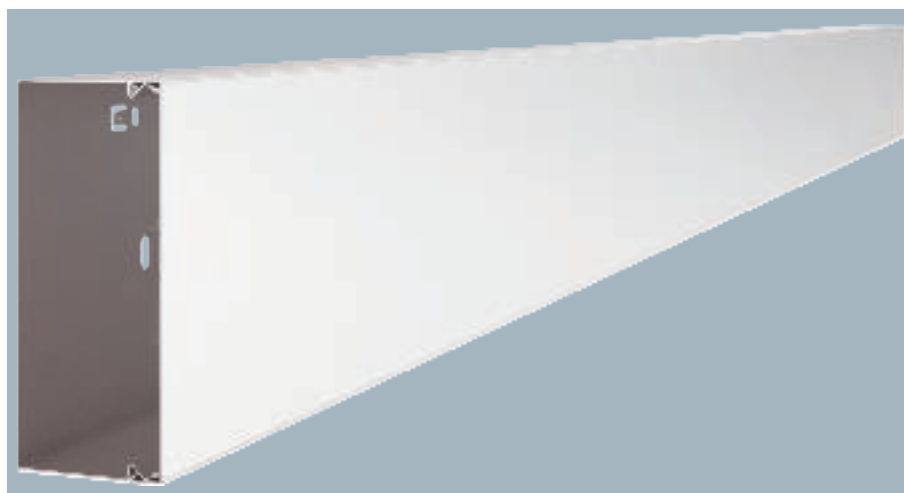
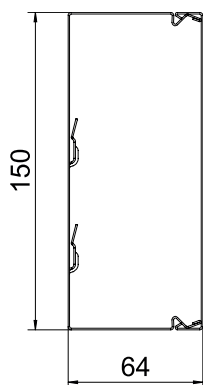

Trunking cover and base with base perforation. Equipotential bonding is guaranteed between the cover and the base without any additional aids.

Type	Colour	Length mm	Pack m	Weight kg/100 m	Item no.
LKM60150RW	Pure white	2000	8	280.100	6248640

VA 2B

Joint connector LKM SV60

Type	Dim. mm	Dim. b mm	Pack Piece	Weight kg/100 pc.	Item no.
LKM SV60	75	49	10	1.600	6247466

Joint connector to connect the bases. This creates the equipotential bonding between the duct bases.

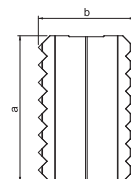

Internal corner, for cable trunking type LKM 60150

St FS

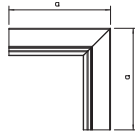

Type	Colour	Dim. mm	Pack Piece	Weight kg/100 pc.	Item no.
LKM I60150FS	–	160	1	48.400	6248152

Internal corner for changing the direction of the LKM trunking.

Internal corner, for cable trunking type LKM 60150

St FSK

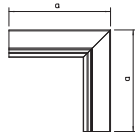

Type	Colour	Dim. mm	Pack Piece	Weight kg/100 pc.	Item no.
LKM I60150RW	Pure white	160	1	48.400	6249647

Internal corner for changing the direction of the LKM trunking.

External corner, for cable trunking type LKM 60150

St FS

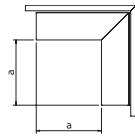
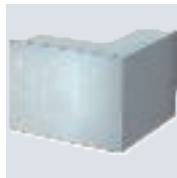

Type	Colour	Dim. mm	Pack Piece	Weight kg/100 pc.	Item no.
LKM A60150FS	–	120	1	91.300	6248071

External corner including cover for changing the direction of the LKM ducts.

External corner, for cable trunking type LKM 60150

St FSK

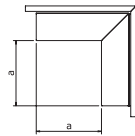

Type	Colour	Dim. mm	Pack Piece	Weight kg/100 pc.	Item no.
LKM A60150RW	Pure white	120	1	91.300	6249582

External corner including cover for changing the direction of the LKM ducts.

T piece, for cable trunking type LKM 60150

St FS

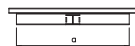

Type	Colour	Dim. mm	Pack Piece	Weight kg/100 pc.	Item no.
LKM T60150FS	–	300	1	87.600	6248217

T piece including cover for changing the direction of the LKM ducts.

St FSK

T piece, for cable trunking type LKM 60150

Type	Colour	Dim. mm	Pack Piece	Weight kg/100 pc.	Item no.
LKM T60150RW	Pure white	300	1	87.600	6249728

T piece including cover for changing the direction of the LKM ducts.

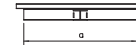

St FS

Flat angle, for cable trunking type LKM 60150

Type	Colour	Dim. mm	Pack Piece	Weight kg/100 pc.	Item no.
LKM F60150FS	–	140	1	113.500	6248012

Flat angle including cover for changing the direction of the LKM ducts.

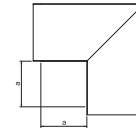

St FSK

Flat angle, for cable trunking type LKM 60150

Type	Colour	Dim. mm	Pack Piece	Weight kg/100 pc.	Item no.
LKM F60150RW	Pure white	140	1	113.500	6249515

Flat angle including cover for changing the direction of the LKM ducts.

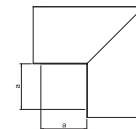

St FS

End piece, for cable trunking type LKM 60150

Type	Colour	Dim. mm	Dim. b mm	Pack Piece	Weight kg/100 pc.	Item no.
LKM E60150FS	–	150	64	10	8.400	6248314

End piece for closing the LKM ducts.

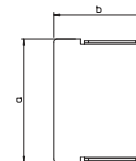

St FSK

End piece, for cable trunking type LKM 60150

Type	Colour	Dim. mm	Dim. b mm	Pack Piece	Weight kg/100 pc.	Item no.
LKM E60150RW	Pure white	150	64	10	9.000	6249825

End piece for closing the LKM ducts.

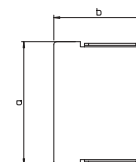

Trunking height 60 mm, trunking width 150 mm

PVC

Edge protection ring KSR60150, for LKM cable trunking type 60150

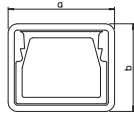

Type	Colour	Dim.		Pack Piece	Weight kg/100 pc.	Item no.
		mm	mm			
KSR60150	Grey	154	68	5	4.400	6249854

Edge protection ring for the open ends of LKM cable trunking.



St FS

Cable trunking, type LKM 60200

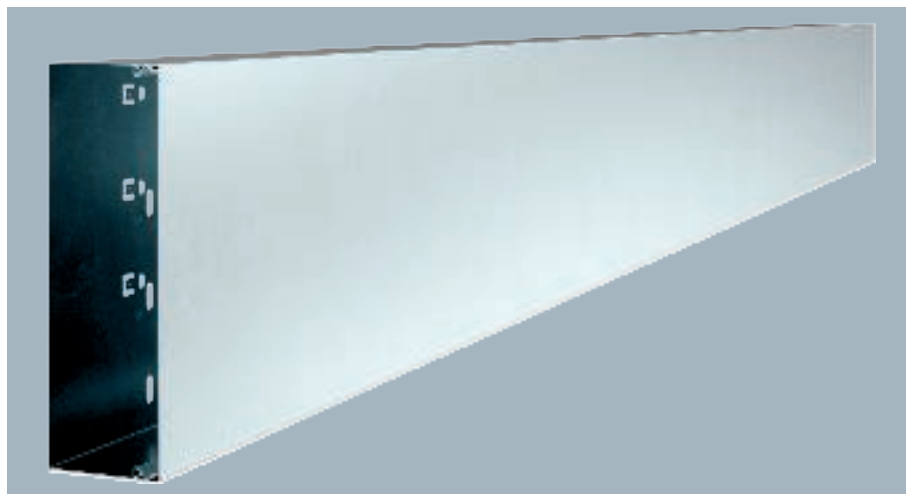
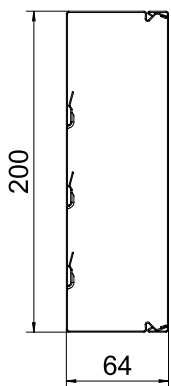

Trunking cover and base with base perforation. Equipotential bonding is guaranteed between the cover and the base without any additional aids.

Type	Colour	Length mm	Pack m	Weight kg/100 m	Item no.
LKM60200FS	—	2000	8	338.700	6247164

St FSK

Cable trunking, type LKM 60200

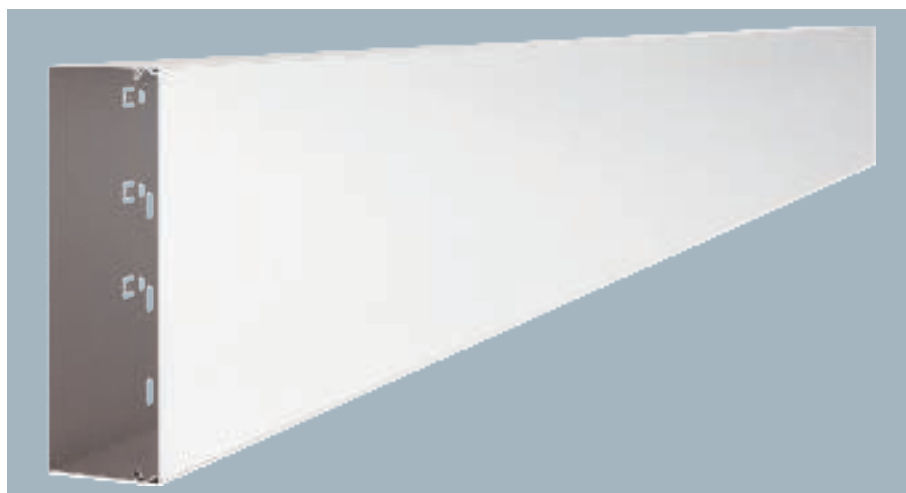
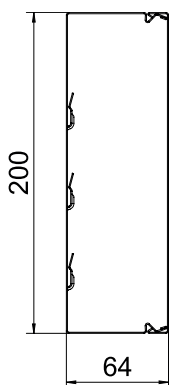

Trunking cover and base with base perforation. Equipotential bonding is guaranteed between the cover and the base without any additional aids.

Type	Colour	Length mm	Pack m	Weight kg/100 m	Item no.
LKM60200RW	Pure white	2000	8	338.700	6248667

VA 2B

Joint connector LKM SV60

Type	Dim. mm	Dim. b mm	Pack Piece	Weight kg/100 pc.	Item no.
LKM SV60	75	49	10	1.600	6247466

Joint connector to connect the bases. This creates the equipotential bonding between the duct bases.

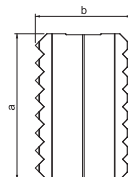

Internal corner, for cable trunking type LKM 60200

St FS

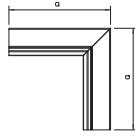
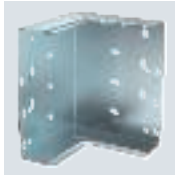

Type	Colour	Dim. mm	Pack Piece	Weight kg/100 pc.	Item no.
LKM I60200FS	–	160	1	57.500	6248160

Internal corner for changing the direction of the LKM trunking.

Internal corner, for cable trunking type LKM 60200

St FSK

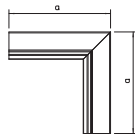

Type	Colour	Dim. mm	Pack Piece	Weight kg/100 pc.	Item no.
LKM I60200RW	Pure white	160	1	57.500	6249655

Internal corner for changing the direction of the LKM trunking.

External corner, for cable trunking type LKM 60200

St FS

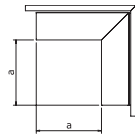

Type	Colour	Dim. mm	Pack Piece	Weight kg/100 pc.	Item no.
LKM A60200FS	–	120	1	114.000	6248098

External corner including cover for changing the direction of the LKM ducts.

External corner, for cable trunking type LKM 60200

St FSK

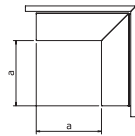

Type	Colour	Dim. mm	Pack Piece	Weight kg/100 pc.	Item no.
LKM A60200RW	Pure white	120	1	114.000	6249590

External corner including cover for changing the direction of the LKM ducts.

T piece, for cable trunking type LKM 60200

St FS

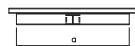

Type	Colour	Dim. mm	Pack Piece	Weight kg/100 pc.	Item no.
LKM T60200FS	–	300	1	106.000	6248225

T piece including cover for changing the direction of the LKM trunking.

St FSK

T piece, for cable trunking type LKM 60200

Type	Colour	Dim. mm	Pack Piece	Weight kg/100 pc.	Item no.
LKM T60200RW	Pure white	300	1	106.000	6249736

T piece including cover for changing the direction of the LKM trunking.

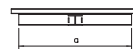

St FS

Flat angle, for cable trunking type LKM 60200

Type	Colour	Dim. mm	Pack Piece	Weight kg/100 pc.	Item no.
LKM F60200FS	–	140	1	154.400	6248020

Flat angle including cover for changing the direction of the LKM ducts.

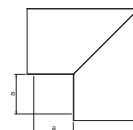

St FSK

Flat angle, for cable trunking type LKM 60200

Type	Colour	Dim. mm	Pack Piece	Weight kg/100 pc.	Item no.
LKM F60200RW	Pure white	140	1	154.400	6249523

Flat angle including cover for changing the direction of the LKM ducts.

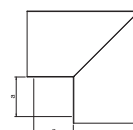

St FS

End piece, for cable trunking type LKM 60200

Type	Colour	Dim. mm	Dim. b mm	Pack Piece	Weight kg/100 pc.	Item no.
LKM E60200FS	–	200	64	10	10.800	6248322

End piece for closing the LKM ducts.

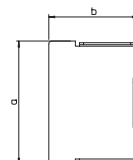

St FSK

End piece, for cable trunking type LKM 60200

Type	Colour	Dim. mm	Dim. b mm	Pack Piece	Weight kg/100 pc.	Item no.
LKM E60200RW	Pure white	200	64	10	11.500	6249833

End piece for closing the LKM ducts.

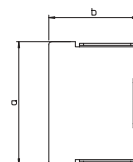

Trunking height 60 mm, trunking width 200 mm

PE

Edge protection ring KSR60200, for LKM cable trunking type 60200

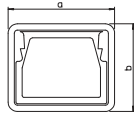

Type	Colour	Dim.		Pack Piece	Weight kg/100 pc.	Item no.
		mm	mm			
KSR60200	Grey	204	68	5	4.700	6249856

Edge protection ring for the open ends of LKM cable trunking.



St FS

Cable trunking, type LKM 80080

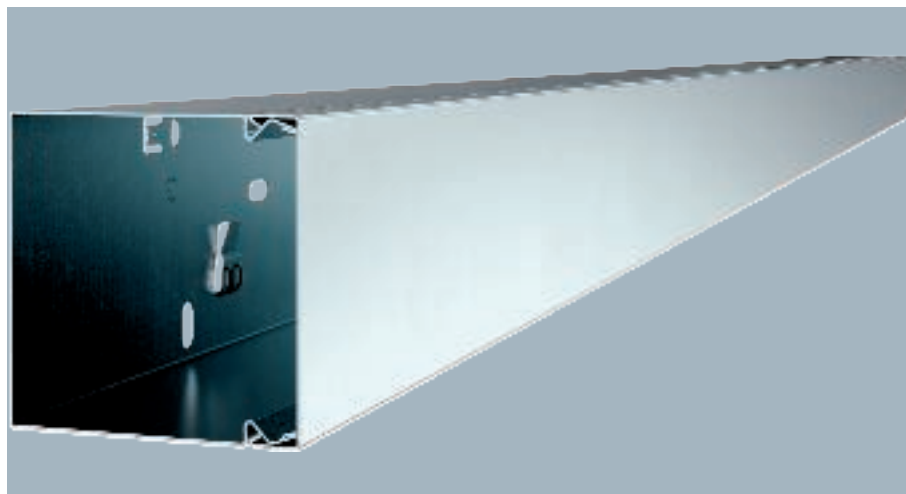
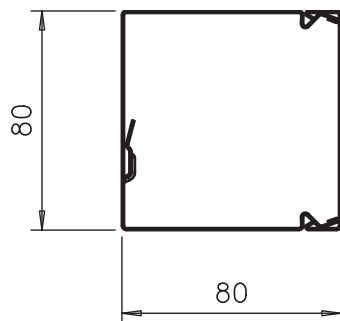

Trunking cover and base with base perforation. Equipotential bonding is guaranteed between the cover and the base without any additional aids.

Type	Colour	Length mm	Pack m	Weight kg/100 m	Item no.
LKM80080FS	–	2000	12	215.000	6247194

St FSK

Cable trunking, type LKM 80080

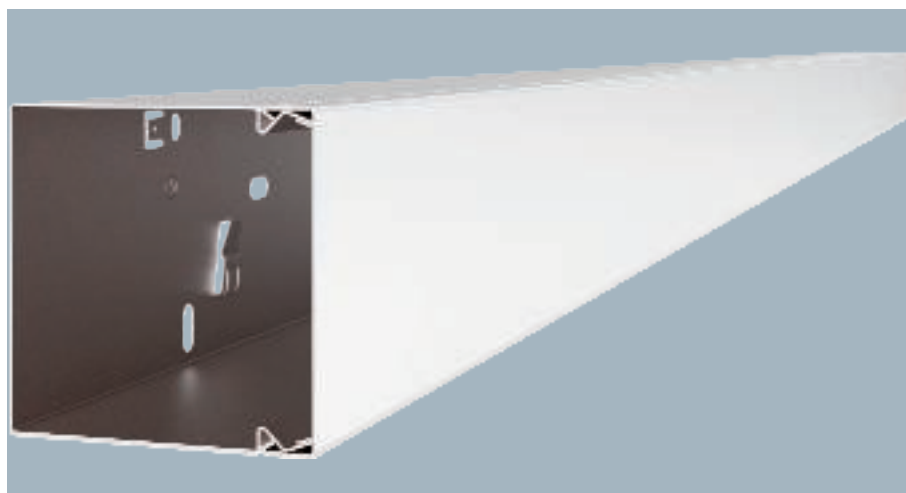
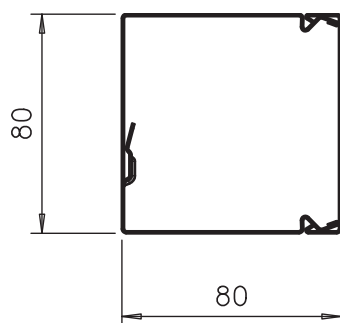

Trunking cover and base with base perforation. Equipotential bonding is guaranteed between the cover and the base without any additional aids.

Type	Colour	Length mm	Pack m	Weight kg/100 m	Item no.
LKM80080RW	Pure white	2000	8	238.000	6248694

VA 2B

Joint connector LKM SV80

Type	Dim. mm	Dim. b mm	Pack Piece	Weight kg/100 pc.	Item no.
LKM SV80	75	66	10	1.300	6247472

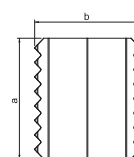

Joint connector to connect the bases. This creates the equipotential bonding between the duct bases.

Internal corner, for cable trunking type LKM 80080

St FS

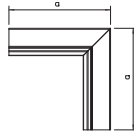

Type	Colour	Dim. mm	Pack Piece	Weight kg/100 pc.	Item no.
LKM I80080FS	–	160	1	38.700	6248336

Internal corner for changing the direction of LKM trunking.

Internal corner, for cable trunking type LKM 80080

St FSK

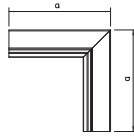

Type	Colour	Dim. mm	Pack Piece	Weight kg/100 pc.	Item no.
LKM I80080RW	Pure white	160	1	38.700	6248436

Internal corner for changing the direction of LKM trunking.

External corner, for cable trunking type LKM 80080

St FS

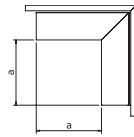

Type	Colour	Dim. mm	Pack Piece	Weight kg/100 pc.	Item no.
LKM A80080FS	–	120	1	75.300	6248332

External corner including cover for changing the direction of the LKM ducts.

External corner, for cable trunking type LKM 80080

St FSK

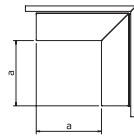

Type	Colour	Dim. mm	Pack Piece	Weight kg/100 pc.	Item no.
LKM A80080RW	Pure white	120	1	75.300	6248432

External corner including cover for changing the direction of the LKM ducts.

T piece, for cable trunking type LKM 80080

St FS

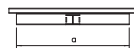

Type	Colour	Dim. mm	Pack Piece	Weight kg/100 pc.	Item no.
LKM T80080FS	–	300	1	67.200	6248340

T piece including cover for changing the direction of the LKM ducts.

St FSK

T piece, for cable trunking type LKM 80080

Type	Colour	Dim. mm	Pack Piece	Weight kg/100 pc.	Item no.
LKM T80080RW	Pure white	300	1	67.200	6248450

T piece including cover for changing the direction of the LKM ducts.

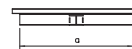

St FS

Flat angle, for cable trunking type LKM 80080

Type	Colour	Dim. mm	Pack Piece	Weight kg/100 pc.	Item no.
LKM F80080FS	—	140	1	80.000	6248328

Flat angle including cover for changing the direction of the LKM ducts.

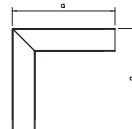

St FSK

Flat angle, for cable trunking type LKM 80080

Type	Colour	Dim. mm	Pack Piece	Weight kg/100 pc.	Item no.
LKM F80080RW	Pure white	140	1	80.000	6248428

Flat angle including cover for changing the direction of the LKM ducts.

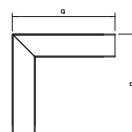

St FS

End piece, for cable trunking type LKM 80080

Type	Colour	Dim. mm	Dim. b mm	Pack Piece	Weight kg/100 pc.	Item no.
LKM E80080FS	—	80	80	1	7.000	6248344

End piece for closing the LKM ducts.

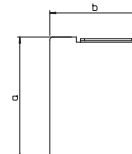

St FSK

End piece, for cable trunking type LKM 80080

Type	Colour	Dim. mm	Dim. b mm	Pack Piece	Weight kg/100 pc.	Item no.
LKM E80080RW	Pure white	80	80	1	7.000	6248454

End piece for closing the LKM ducts.

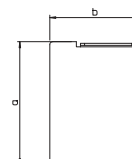

Trunking height 80 mm, trunking width 80 mm

PE

Edge protection ring KSR80080, for LKM cable trunking 80080

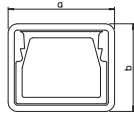

Type	Colour	Dim.		Pack Piece	Weight kg/100 pc.	Item no.
		Dim. mm	b mm			
KSR80080	Grey	84	84	5	3.800	6249865

Edge protection ring for the open ends of LKM cable trunking.





Partition for WDK trunking, trunking height 40 mm

PVC

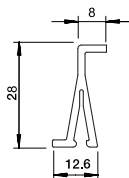

Type	Colour	Length mm	Pack m	Weight kg/100 m	Item no.
2371 40	Light grey	2000	60	13.500	6023096

Partition to divide the WDK trunking, with 40 mm trunking height, and various ISS service poles for the installation of different voltage levels.

Partition for WDKH trunking, trunking height 40 mm

PC/ABS

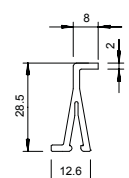

Type	Colour	Length mm	Pack m	Weight kg/100 m	Item no.
WDKH-TW40LGR	Light grey	2000	60	13.350	6175500

Partition to divide the WDKH trunking of 40 mm trunking height for the installation of different voltage levels.

Partition for WDK trunking, trunking height 60 mm

PVC

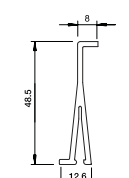

Type	Colour	Length mm	Pack m	Weight kg/100 m	Item no.
2371 60	Light grey	2000	40	17.000	6023118

Partition to divide the WDK trunking, with 60 mm trunking height for the installation of different voltage levels.

Partition, halogen-free, for trunking height 60 mm

PC/ABS

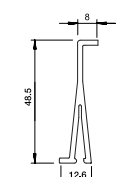

Type	Colour	Length mm	Pack m	Weight kg/100 m	Item no.
WDKH-TW60LGR	Light grey	2000	40	20.650	6175504

Partition to divide the WDKH trunking of 60 mm trunking height for the installation of different voltage levels.

Partition for WDK trunking, trunking height 80 mm

PVC

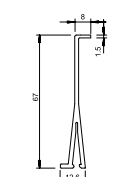

Type	Colour	Length mm	Pack m	Weight kg/100 m	Item no.
2371 80	Light grey	2000	40	33.000	6026982

Partition to divide the WDK trunking, with 80 mm trunking height for the installation of different voltage levels.

PVC

Partition for WDK trunking, trunking height 100 mm

Type	Colour	Length mm	Pack m	Weight kg/100 m	Item no.
2371 100	Light grey	2000	20	40.000	6026990

Partition to divide the WDK trunking, with 100 mm trunking height for the installation of different voltage levels.

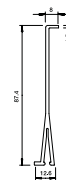

St FS

Partition LKM/TWS55

Type	Length mm	Dim. mm	Pack m	Weight kg/100 m	Item no.
LKM TWS55	2000	55	32	53.000	6249876
LKM TWS75	2000	60	32	114.000	6249880
LKM TWS45	2000	45	2	47.900	6249871

Partition to divide the LKM cable routing trunking, 60 mm duct height, for different voltage levels.

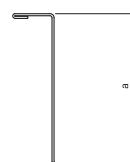

Trunking clips

St FS

Duct clamp, LKM, for maintenance of electrical function E30 - E90

Type	Pack Piece	Weight kg/100 pc.	Item no.
LKM KF 60100	10	9.800	6249881

Duct clamp for the metal cable routing duct type LKM 60100FS, prevents the cables falling out during installation. The duct clamp is essential if the duct is used in cable systems with integrated maintenance of electrical function to DIN 4102, Part 12. Easy mounting through insertion into the loop perforation in the side wall.

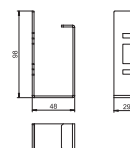

Plastic cable routing trunking accessories

PA

Knock-in anchor

Type	Dowel Ø mm	Length mm	Pull-out force N min/concrete	Pack Piece	Weight kg/100 pc.	Item no.
910 SD 6X35	6	35	260	100	0.310	2351056



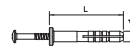

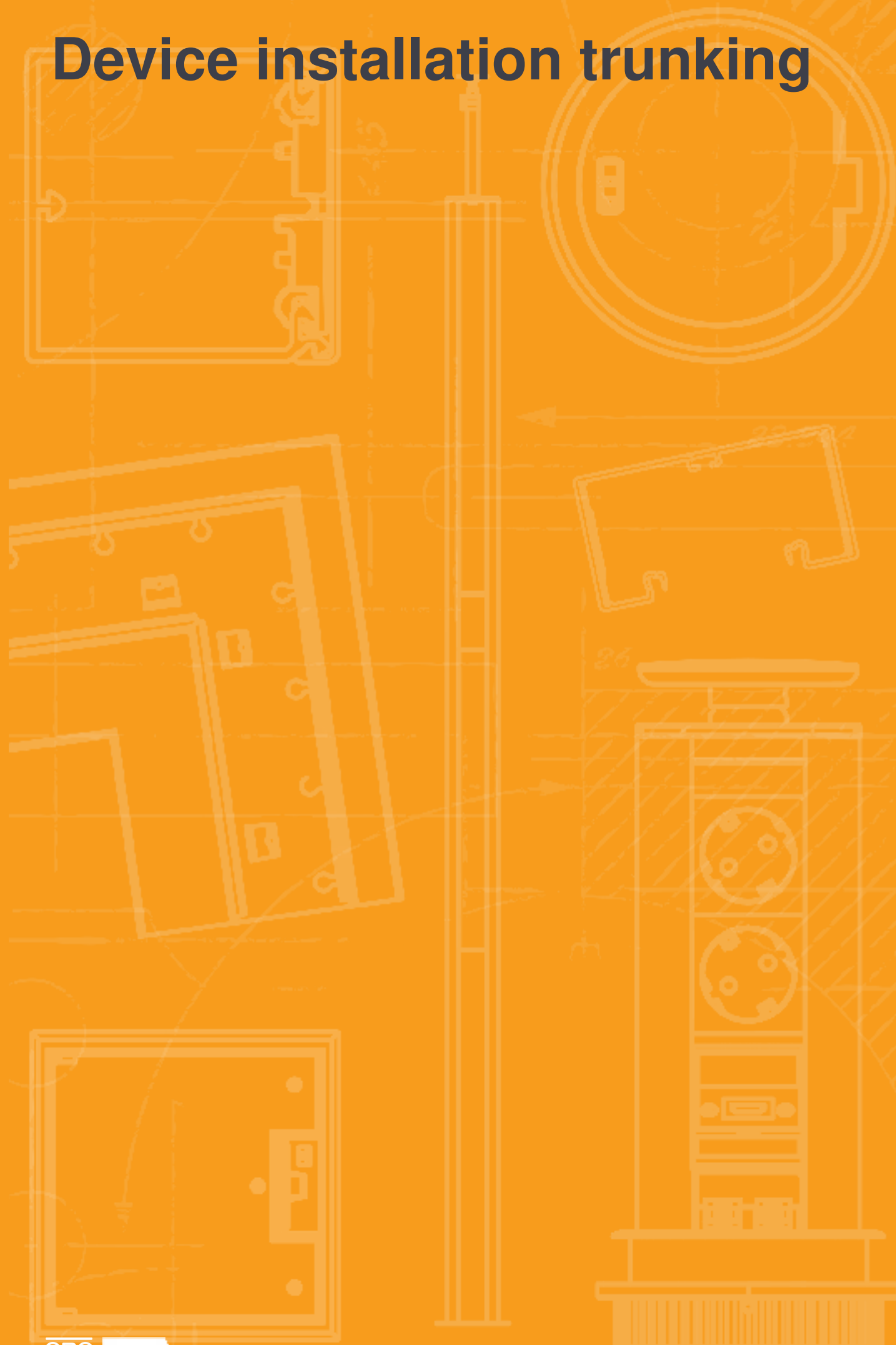

Knock-in anchor: steel, electrogalvanised and transparently passivated.



Device installation trunking



Device installation trunking

	Rapid 45-2 device installation trunking	124
	{Geräteeinbaukanäle Rapid 45-2, halogenfrei}	140
	Device installation trunking Rapid 45-2, aluminium	144
	Rapid 45-2 device installation trunking covers	158
	Rapid 80 device installation ducts	160
	Rapid 80 device installation ducts, halogen-free	172
	Device installation trunking Rapid 80, metal	182
	Device installation trunking Rapid 80, aluminium	216
	Fastening panel, mounting accessories for device installation ducts	242
	Accessories, device installation ducts	244



Installing intelligently

Rapid 45-2 device installation trunking & Modul 45

Rapid 45-2

The new Rapid 45 generation combines symmetrical design, homogenous colour quality and technical flexibility in one system. Innovative fittings allow practical wall installations in administrative buildings, commercial areas and in industry.



Plastic

Aluminium

Slim design

Devices snap-in quickly

Extensive range of accessories



Modul 45 installation devices

- Space-saving installation
- Extensive range of switches, sockets and data technology equipment
- Simple and quick planning



Rapid 45-2 GK device installation trunking

Installation principle



1	Device installation trunking	GK	11	T piece adapter on WDK	GK-TA WDK
2	Trunking connector and joint cover	GK-KS	12	End piece	GK-E
3	Joint cover	GK-KSOT	13	Partition	GK-TW
4	External corner	GK-AS			
5	External corner cover	GK-AH			
6	Flat angle	GK-AS			
7	Flat angle cover	GK-AH			
8	Internal corner	GK-IS			
9	Internal corner cover	GK-IH			
10	T piece adapter	GK-TR			



Trunking height 53 mm, trunking width 100 mm

PVC

Device installation trunking Rapid 45-2, trunking width 100, trunking height 53



Type	Colour	Length mm	Pack m	Weight kg/100 m	Item no.
GK-53100RW	Pure white	2000	12	130.300	6113000
GK-53100LGR	Light grey	2000	12	130.300	6113002
GK-53100SW	Jet black	2000	12	130.300	6113003

Trunking base and cover with base perforation for direct wall mounting.

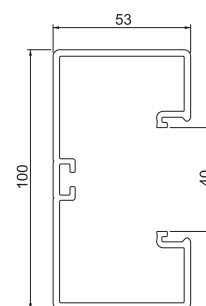

Trunking connector and joint cover

PC/ABS



Type	Colour	Additional information	Pack Piece	Weight kg/100 pc.	Item no.
GK-KS45-1RW	Pure white	–	6	0.861	6113020
GK-KS45-1LGR	Light grey	–	6	0.861	6113022

Joint cover for the bases of the Rapid 45-2 device installation trunking to hide cut edges and provide a perfect connection of the trunking segments. The joint covers are attached. Suitable for trunking width 100 mm and 165 mm.

Flat angle, for device installation trunking Rapid 45-2 type GK-53100

PVC

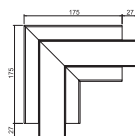

Type	Colour	Pack Piece	Weight kg/100 pc.	Item no.
GK-FS53100RW	Pure white	1	34.600	6113080
GK-FS53100LGR	Light grey	1	34.600	6113082

Flat angle for changing the direction of the Rapid 45-2 device installation trunking.

PC / ABS

Flat angle, for device installation trunking Rapid 45-2 type GK-53100

Type	Colour	Additional information	Pack Piece	Weight kg/100 pc.	Item no.
GK-FH53100RW	Pure white	—	2	10.911	6113090
GK-FH53100LGR	Light grey	—	2	10.911	6113092
GK-FH53100SW	Black	EE	1	—	6112994
GK-FH53100SW	Black	LT	1	—	6112974
GK-FH53100SW	Black	LV	1	—	6112984

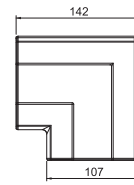

Flat angle as hood fitting for changing the direction of the Rapid 45-2 device installation trunking.

PVC

Internal corner, for device installation trunking Rapid 45-2 type GK-53100

Type	Colour	Pack Piece	Weight kg/100 pc.	Item no.
GK-IS53100RW	Pure white	1	34.200	6113060
GK-IS53100LGR	Light grey	1	34.200	6113062

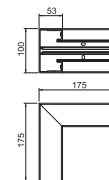

90° internal corner for changing the direction of the Rapid 45-2 device installation trunking.

PC / ABS

Internal corner, for device installation trunking Rapid 45-2 type GK-53100

Type	Colour	Additional information	Pack Piece	Weight kg/100 pc.	Item no.
GK-IH53100RW	Pure white	—	1	12.856	6113070
GK-IH53100LGR	Light grey	—	1	12.856	6113072
GK-IH53100SW	Black	EE	1	—	6112992
GK-IH53100SW	Black	LT	1	—	6112972
GK-IH53100SW	Black	LV	1	—	6112982

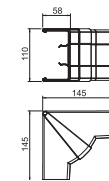

Internal corner for changing the direction of Rapid 45 device installation trunking.

PVC

External corner, for device installation trunking Rapid 45-2 type GK-53100

Type	Colour	Pack Piece	Weight kg/100 pc.	Item no.
GK-AS53100RW	Pure white	1	40.400	6113040
GK-AS53100LGR	Light grey	1	40.400	6113042

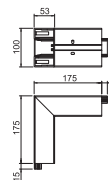

90° fixed external corner for changing the direction of Rapid 45-2 device installation trunking.



External corner, for device installation trunking Rapid 45-2 type GK-53100

PC/
ABS



Type	Colour	Additional information	Pack Piece	Weight kg/100 pc.	Item no.
GK-AH53100RW	Pure white	—	1	7.153	6113050
GK-AH53100LGR	Light grey	—	1	7.153	6113052
GK-AH53100SW	Black	EE	1	—	6112993
GK-AH53100SW	Black	LT	1	—	6112973
GK-AH53100SW	Black	LV	1	—	6112983

External corner for changing the direction of Rapid 45-2 device installation trunking. The fittings can be adjusted between 80–110°.

T piece adapter, for device installation trunking Rapid 45-2 type GK-53100

PC/
ABS

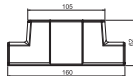

Type	Colour	Additional information	Pack Piece	Weight kg/100 pc.	Item no.
GK-TR53100RW	Pure white	—	1	3.405	6113100
GK-TR53100LGR	Light grey	—	1	3.405	6113102
GK-TR53100SW	Black	EE	1	—	6112995
GK-TR53100SW	Black	LT	1	—	6112975
GK-TR53100SW	Black	LV	1	—	6112985

T piece to create a 90° junction of the system size 53100 on the system size 53100.

T piece adapter WDK 40060

PC/
ABS

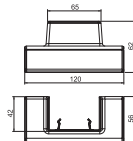

Type	Colour	Pack Piece	Weight kg/100 pc.	Item no.
GK-TA WDK 1RW	Pure white	1	3.002	6113310

T-piece adapter to create a 90° junction from the system size Rapid 45-2 53100 and 53165 on a cable trunking WDK40060.

End piece, for device installation trunking Rapid 45-2 type GK-53100

PC/
ABS

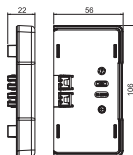

Type	Colour	Additional information	Pack Piece	Weight kg/100 pc.	Item no.
GK-E53100RW	Pure white	—	1	2.493	6113110
GK-E53100LGR	Light grey	—	1	2.493	6113112
GK-E53100SW	Black	EE	1	—	6112990
GK-E53100SW	Black	LT	1	—	6112970
GK-E53100SW	Black	LV	1	—	6112980

End piece for side closing of the Rapid 45-2 GK and GA 53100 device installation trunking.

Cover, for device installation trunking Rapid 45-2

PVC

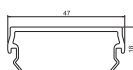

Type	Colour	Length mm	Pack m	Weight kg/100 m	Item no.
GK-OT45RW	Pure white	2000	24	20.550	6113010
GK-OT45LGR	Light grey	2000	24	20.550	6113012

Trunking cover for closing the Rapid 45-2 device installation trunking.

PVC

Partition GK-TW53

Type	Length mm	Pack m	Weight kg/100 m	Item no.
GK-TW53	2000	40	28.700	6113290

Partition for mounting in Rapid 45-2 GK and GA device installation trunking for installing cables of different voltage levels.

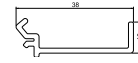

Trunking height 53 mm, trunking width 130 mm

PVC

Device installation trunking Rapid 45-2, trunking width 130, trunking height 53



Type	Colour	Length mm	Pack m	Weight kg/100 m	Item no.
GK-53130RW	Pure white	2000	8	174.000	6113200
GK-53130LGR	Light grey	2000	8	174.000	6113202

Trunking base and cover with base perforation for direct wall mounting.

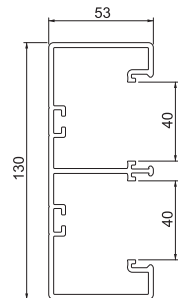

Trunking connector and joint cover

PC/ABS



Type	Colour	Pack Piece	Weight kg/100 pc.	Item no.
GK-KS45-2RW	Pure white	6	0.707	6113210
GK-KS45-2LGR	Light grey	6	0.707	6113212

Joint cover for the bases of the Rapid 45 device installation trunking to hide cut edges and provide a perfect connection of the trunking segments. The joint covers are attached. Suitable for trunking width 130 mm.

Flat angle, for device installation trunking Rapid 45-2 type GK-53130

PVC

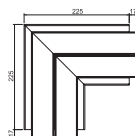

Type	Colour	Pack Piece	Weight kg/100 pc.	Item no.
GK-FS53130RW	Pure white	1	60.200	6113260
GK-FS53130LGR	Light grey	1	60.200	6113262

Flat angle for changing the direction of the Rapid 45-2 device installation trunking.

PC / ABS

Flat angle, for device installation trunking Rapid 45-2 type GK-53130

Type	Colour	Pack Piece	Weight kg/100 pc.	Item no.
GK-FH53130RW	Pure white	2	14.754	6113270
GK-FH53130LGR	Light grey	2	14.754	6113272

Flat angle as hood fitting for changing the direction of the Rapid 45-2 device installation trunking.

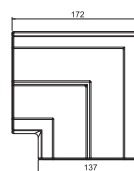

PVC

Internal corner, for Rapid 45-2 device installation trunking, type GK-53130

Type	Colour	Pack Piece	Weight kg/100 pc.	Item no.
GK-IS53130RW	Pure white	1	44.400	6113240
GK-IS53130LGR	Light grey	1	44.400	6113242

90° internal corner for changing the direction of the Rapid 45-2 device installation trunking.

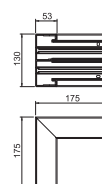

PC / ABS

Internal corner, for Rapid 45-2 device installation trunking, type GK-53130

Type	Colour	Pack Piece	Weight kg/100 pc.	Item no.
GK-IH53130RW	Pure white	1	14.730	6113250
GK-IH53130LGR	Light grey	1	14.730	6113252

Internal corner for changing the direction of Rapid 45 device installation trunking.

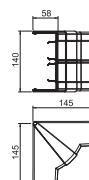

PVC

External corner, for device installation trunking Rapid 45-2 type GK-53130

Type	Colour	Pack Piece	Weight kg/100 pc.	Item no.
GK-AS53130RW	Pure white	1	56.200	6113220
GK-AS53130LGR	Light grey	1	56.200	6113222

External corner 90° for changing the direction of Rapid 45-2 device installation trunking.

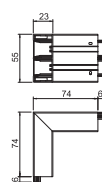

PC / ABS

External corner cover

Type	Colour	Pack Piece	Weight kg/100 pc.	Item no.
GK-AH53130RW	Pure white	1	8.440	6113230
GK-AH53130LGR	Light grey	1	8.440	6113232

External corner for changing the direction of Rapid 45-2 device installation trunking. The fittings can be adjusted between 80–110°.

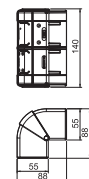

T piece adapter, for device installation trunking Rapid 45-2 type GK-53130

PC/ABS

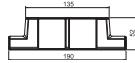
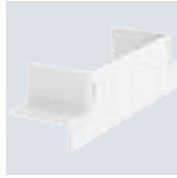

Type	Colour		Pack Piece	Weight kg/100 pc.	Item no.
GK-TR53130RW	Pure white		1	3.514	6113300
GK-TR53130LGR	Light grey		1	3.514	6113302

T piece adapter to create a 90° junction of the system size 53130 on the system size 53130.

T piece adapter on WDK 40060

PC/ABS

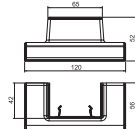

Type	Colour		Pack Piece	Weight kg/100 pc.	Item no.
GK-TA WDK 2RW	Pure white		1	2.717	6113320
GK-TA WDK 2LGR	Light grey		1	2.670	6113322

T-piece adapter to create a 90° junction from the system size Rapid 45-2 53130 to a cable trunking WDK40060.

End piece, for device installation trunking Rapid 45-2 type GK-53130

PC/ABS

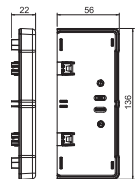

Type	Colour		Pack Piece	Weight kg/100 pc.	Item no.
GK-E53130RW	Pure white		1	2.972	6113280
GK-E53130LGR	Light grey		1	2.972	6113282

End piece for side closing of the Rapid 45-2 GK and GA 53130 device installation trunking.

Cover, for device installation trunking Rapid 45-2

PVC

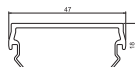

Type	Colour	Length mm	Pack m	Weight kg/100 m	Item no.
GK-OT45LGR	Light grey	2000	24	20.550	6113012

Trunking cover for closing the Rapid 45-2 device installation trunking.

Partition GK-TW53

PVC

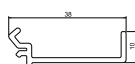

Type	Length mm	Pack m	Weight kg/100 m	Item no.

Partition for mounting in Rapid 45-2 GK and GA device installation trunking for installing cables of different voltage levels.

PVC

Device installation trunking Rapid 45-2, trunking width 165, trunking height 53



Trunking base and cover with base perforation for direct wall mounting.

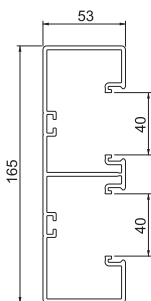

Type	Colour	Length mm	Pack m	Weight kg/100 m	Item no.
GK-53165RW	Pure white	2000	8	216.250	6113400
GK-53165LGR	Light grey	2000	8	216.250	6113402

PC / ABS

Trunking connector and joint cover

Type	Colour	Pack Piece	Weight kg/100 pc.	Item no.
GK-KS45-1RW	Pure white	6	0.861	6113020
GK-KS45-1LGR	Light grey	6	0.861	6113022

Joint cover for the bases of the Rapid 45-2 device installation trunking to hide cut edges and provide a perfect connection of the trunking segments. The joint covers are attached. Suitable for trunking width 100 mm and 165 mm.

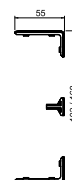

PVC

Flat angle, for device installation trunking Rapid 45-2 type GK-53165

Type	Colour	Pack Piece	Weight kg/100 pc.	Item no.
GK-FS53165RW	Pure white	1	64.500	6113450
GK-FS53165LGR	Light grey	1	64.500	6113452

Flat angle for changing the direction of the Rapid 45-2 device installation trunking.

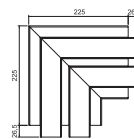

Trunking height 53 mm, trunking width 165 mm

Flat angle, for device installation trunking Rapid 45-2 type GK-53165

PC/
ABS

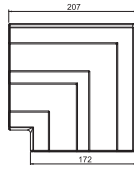

Type	Colour	Pack Piece	Weight kg/100 pc.	Item no.
GK-FH53165RW	Pure white	2	16.300	6113460
GK-FH53165LGR	Light grey	2	16.300	6113462

Flat angle as hood fitting for changing the direction of the Rapid 45-2 device installation trunking.

Internal corner, for Rapid 45-2 device installation trunking, type GK-53165

PVC

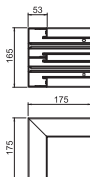
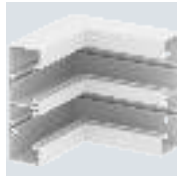

Type	Colour	Pack Piece	Weight kg/100 pc.	Item no.
GK-IS53165RW	Pure white	1	54.500	6113430
GK-IS53165LGR	Light grey	1	54.500	6113432

90° internal corner for changing the direction of the Rapid 45-2 device installation trunking.

Internal corner, for Rapid 45-2 device installation trunking, type GK-53165

PC/
ABS

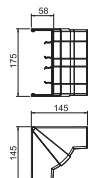

Type	Colour	Pack Piece	Weight kg/100 pc.	Item no.
GK-IH53165RW	Pure white	1	15.634	6113440
GK-IH53165LGR	Light grey	1	15.634	6113442

Internal corner for changing the direction of Rapid 45 device installation trunking.

External corner, for device installation trunking Rapid 45-2 type GK-53165

PVC

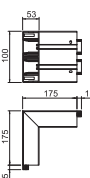

Type	Colour	Pack Piece	Weight kg/100 pc.	Item no.
GK-AS53165RW	Pure white	1	66.800	6113410
GK-AS53165LGR	Light grey	1	66.800	6113412

External corner 90° for changing the direction of Rapid 45-2 device installation trunking.

External corner, for device installation trunking Rapid 45-2 type GK-53165

PC/
ABS



Type	Colour	Pack Piece	Weight kg/100 pc.	Item no.
GK-AH53165RW	Pure white	1	9.230	6113420
GK-AH53165LGR	Light grey	1	9.230	6113422

External corner for changing the direction of Rapid 45-2 device installation trunking. The fittings can be adjusted between 80–110°.

PC / ABS

T piece adapter, for device installation trunking Rapid 45-2 type GK-53165

Type	Colour	Pack Piece	Weight kg/100 pc.	Item no.
GK-TR53165RW	Pure white	1	4.545	6113480
GK-TR53165LGR	Light grey	1	4.515	6113482

T-piece adapter to create a 90° junction of the system size 53165 on the system size 53165.

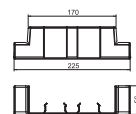

PC / ABS

T piece adapter WDK 40060

Type	Colour	Pack Piece	Weight kg/100 pc.	Item no.
GK-TA WDK 1RW	Pure white	1	3.002	6113310
GK-TA WDK 1LGR	Light grey	1	2.940	6113312

T-piece adapter to create a 90° junction from the system size Rapid 45-2 53100 and 53165 on a cable trunking WDK40060.

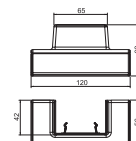

PC / ABS

End piece, for device installation trunking Rapid 45-2 type GK-53165

Type	Colour	Pack Piece	Weight kg/100 pc.	Item no.
GK-E53165RW	Pure white	1	3.561	6113470
GK-E53165LGR	Light grey	1	3.561	6113472

End piece for side closing of the Rapid 45-2 GK and GA 53165 device installation trunking.

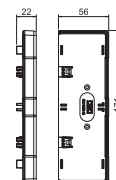

PVC

Cover, for device installation trunking Rapid 45-2

Type	Colour	Length mm	Pack m	Weight kg/100 m	Item no.
GK-OT45RW	Pure white	2000	24	20.550	6113010
GK-OT45LGR	Light grey	2000	24	20.550	6113012

Trunking cover for closing the Rapid 45-2 device installation trunking.

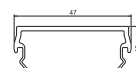

PVC

Partition GK-TW53

Type	Length mm	Pack m	Weight kg/100 m	Item no.
GK-TW53	2000	40	28.700	6113290

Partition for mounting in Rapid 45-2 GK and GA device installation trunking for installing cables of different voltage levels.

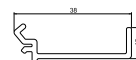

Trunking depth 53 mm, trunking height 160 mm, 3-compartment

PVC

Device installation trunking Rapid 45-2, trunking width 160, trunking height 53

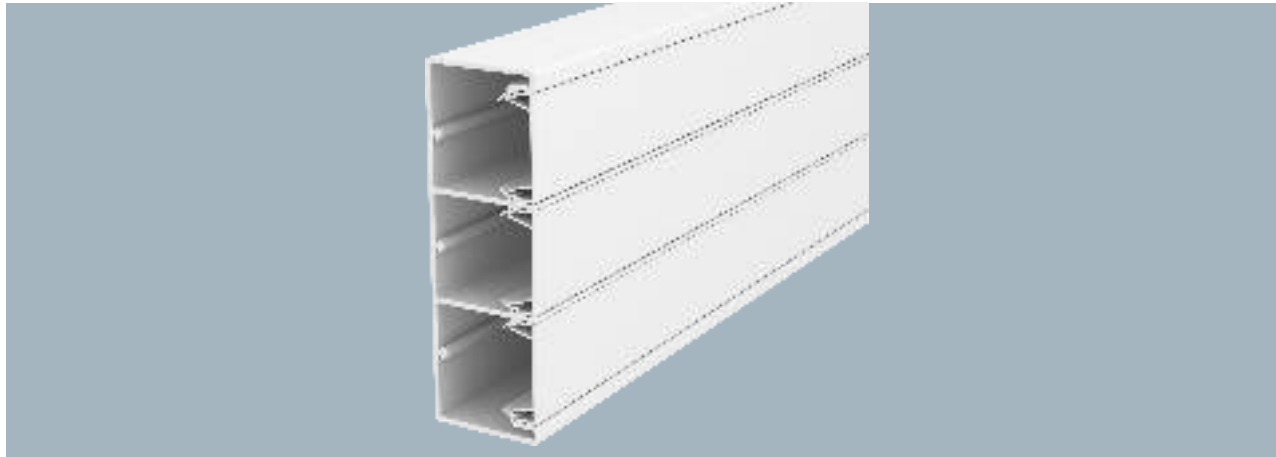

Type	Colour	Length mm	Pack m	Weight kg/100 m	Item no.
GEK-K53160-3	Pure white	2000	8	210.000	6116073

Trunking base and cover with base perforation for direct wall mounting.

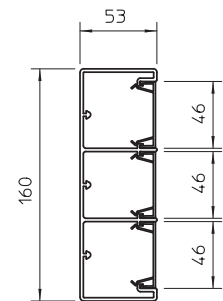

Trunking connector and joint cover

PVC

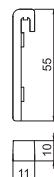

Type	Colour	Pack Piece	Weight kg/100 pc.	Item no.
GEK-KS45-3	Pure white	6	1.324	6116163

Joint cover for smooth connection of trunking segments.

Joint cover

PVC

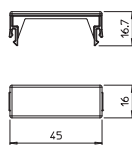

Type	Colour	Pack Piece	Weight kg/100 pc.	Item no.
GEK-KSOT45	Pure white	6	0.284	6116152

Joint cover for the covers of the Rapid 45 device installation trunking to hide cut edges and provide tidy connection to installed Modul 45 devices.

PVC

Flat angle, for device installation trunking Rapid 45-2 type GK-53160

Type	Colour	Pack Piece	Weight kg/100 pc.	Item no.
GEK-KF53160-3	Pure white	1	64.000	6116493

Flat angle for direction change of Rapid 45 device installation trunking, GEK-K53160-3.

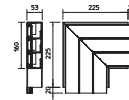

PVC

Internal corner, for device installation trunking Rapid 45-2 type GK-53160

Type	Colour	Pack Piece	Weight kg/100 pc.	Item no.
GEK-KI53160-3	Pure white	2	13.800	6116201

Internal corner as hood fitting for direction change of three-compartment Rapid 45 device installation trunking. The fittings can be variably adjusted between 80 and 103°.

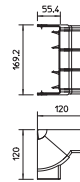

PVC

Internal corner, for device installation trunking Rapid 45-2 type GK-53160

Type	Colour	Pack Piece	Weight kg/100 pc.	Item no.
GEK-KIS53160-3	Pure white	1	48.100	6116203

Rigid 90° internal corner for changing the direction of the Rapid 45 three-compartment device installation trunking.

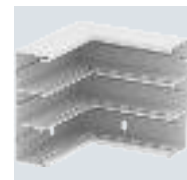
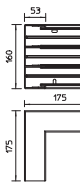

PVC

External corner, for device installation trunking Rapid 45-2 type GK-53160

Type	Colour	Pack Piece	Weight kg/100 pc.	Item no.
GEK-KA53160-3	Pure white	2	22.000	6116261

External corner as hood fitting for direction change of three-compartment Rapid 45 device installation trunking. The fittings can be adjusted variably between 70–130°. Fittings can be adjusted through 70–130°.



PVC

External corner

Type	Colour	Pack Piece	Weight kg/100 pc.	Item no.
GEK-KAS53160-3	Pure white	1	64.000	6116263

Rigid 90° external corner for changing the direction of the Rapid 45 three-compartment device installation trunking.

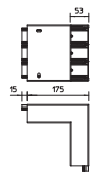

T piece, for device installation trunking Rapid 45-2 type GK-53160

PVC

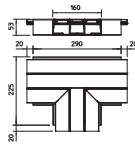

Type	Colour	Pack Piece	Weight kg/100 pc.	Item no.
GEK-KT53160-3	Pure white	1	72.000	6116193

Prefabricated T piece for vertical branch of the Rapid 45 device installation trunking, three-compartment.

End piece, for device installation trunking Rapid 45-2 type GK-53160

PVC

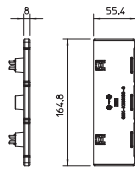

Type	Colour	Pack Piece	Weight kg/100 pc.	Item no.
GEK-KE53160-3	Pure white	8	3.687	6116403

End piece for closing the device installation trunking Rapid 45 GEK-K53160-3. The end pieces are pinned on the connector in the base and held in place.

Cover

PVC

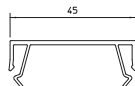

Type	Colour	Length mm	Pack m	Weight kg/100 m	Item no.
GEK-KOT45	Pure white	2000	24	18.600	6116108

Trunking cover for closing the Rapid 45 device installation trunking.

Accessories, trunking height 53

Partition for WDK trunking, trunking height 40 mm

PVC

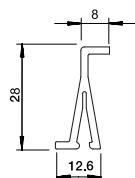

Type	Colour	Length mm	Pack m	Weight kg/100 m	Item no.
2371 40	Light grey	2000	60	13.500	6023096

Partition to divide the WDK trunking, with 40 mm trunking height, and various ISS service poles for the installation of different voltage levels.

The partitions are pinned on the connectors in the base.

Cover clip OK-K 45

VA



Type	Pack Piece	Weight kg/100 pc.	Item no.
OK-K 45	10	0.490	6116116

Cover clip for better and easier cable routing in the Rapid 45 device installation trunking.



Trunking height 53 mm, trunking width 100 mm

PC/
ABS

Device installation trunking Rapid 45-2, trunking width 100, trunking height 53, halogen-free

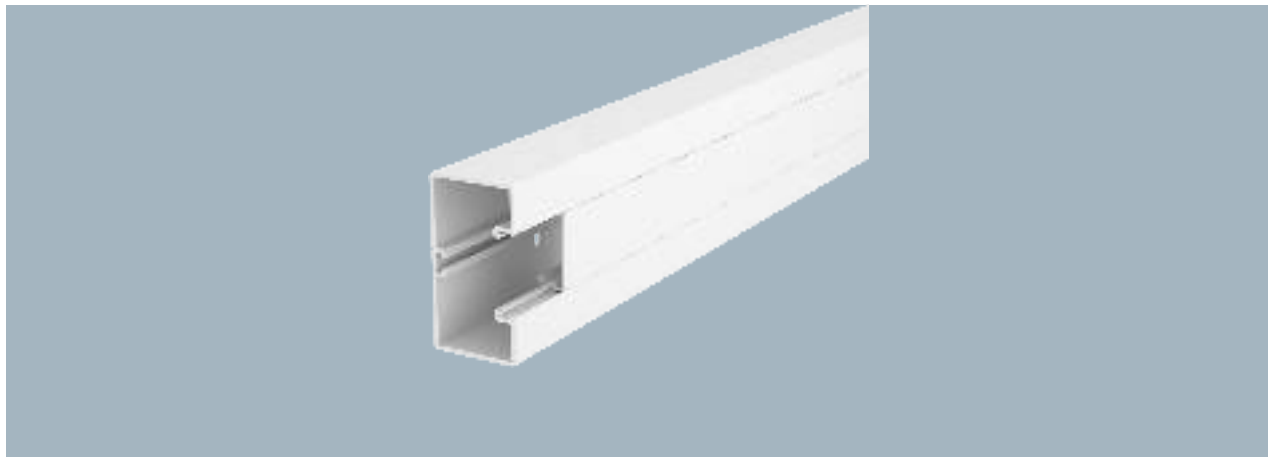

Type	Colour	Length mm	Pack m	Weight kg/100 m	Item no.
GKH-53100RW	Pure white	2000	12	109.700	6114157

Trunking base and cover with base perforation for direct wall mounting.

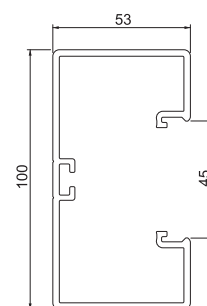

Trunking connector and joint cover

PC/
ABS

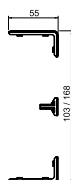
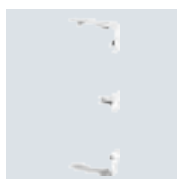

Type	Colour	Additional information	Pack Piece	Weight kg/100 pc.	Item no.
GK-KS45-1RW	Pure white	–	6	0.861	6113020

Joint cover for the bases of the Rapid 45-2 device installation trunking to hide cut edges and provide a perfect connection of the trunking segments. The joint covers are attached. Suitable for trunking width 100 mm and 165 mm.

Flat angle, for device installation trunking Rapid 45-2 type GKH-53100

PC/
ABS

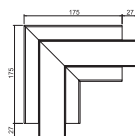

Type	Colour	Pack Piece	Weight kg/100 pc.	Item no.
GKH-FS53100RW	Pure white	1	36.400	6113085

Flat angle for changing the direction of the Rapid 45-2 device installation trunking.

PC / ABS

Flat angle, for device installation trunking Rapid 45-2 type GK-53100

Type	Colour	Additional information	Pack Piece	Weight kg/100 pc.	Item no.
GK-FH53100RW	Pure white	—	2	10.911	6113090

Flat angle as hood fitting for changing the direction of the Rapid 45-2 device installation trunking.

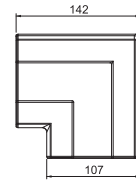

PC / ABS

Internal corner, for device installation trunking Rapid 45-2 type GKH-53100

Type	Colour	Pack Piece	Weight kg/100 pc.	Item no.
GKH-IS53100RW	Pure white	1	34.200	6113065

Internal corner for changing the direction of Rapid 45 device installation trunking.

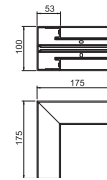

PC / ABS

Internal corner, for device installation trunking Rapid 45-2 type GK-53100

Type	Colour	Additional information	Pack Piece	Weight kg/100 pc.	Item no.
GK-IH53100RW	Pure white	—	1	12.856	6113070

Internal corner for changing the direction of Rapid 45 device installation trunking.

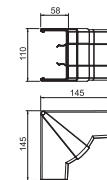

PC / ABS

External corner, for device installation trunking Rapid 45-2 type GK-53100

Type	Colour	Pack Piece	Weight kg/100 pc.	Item no.
GKH-AS53100RW	Pure white	1	40.400	6113045

External corner for changing the direction of Rapid 45-2 device installation trunking. The fittings can be adjusted between 80–110°.

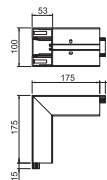

PC / ABS

External corner, for device installation trunking Rapid 45-2 type GK-53100

Type	Colour	Additional information	Pack Piece	Weight kg/100 pc.	Item no.
GK-AH53100RW	Pure white	—	1	7.153	6113050

External corner for changing the direction of Rapid 45-2 device installation trunking. The fittings can be adjusted between 80–110°.

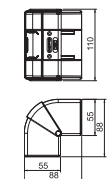

Trunking height 53 mm, trunking width 100 mm

T piece adapter, for device installation trunking Rapid 45-2 type GK-53100

PC/
ABS

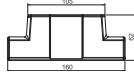
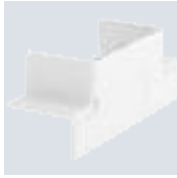

Type	Colour	Additional information	Pack Piece	Weight kg/100 pc.	Item no.
GK-TR53100RW	Pure white	—	1	3.405	6113100

T piece to create a 90° junction of the system size 53100 on the system size 53100.

End piece, for device installation trunking Rapid 45-2 type GK-53100

PC/
ABS

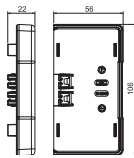

Type	Colour	Additional information	Pack Piece	Weight kg/100 pc.	Item no.
GK-E53100RW	Pure white	—	1	2.493	6113110

End piece for side closing of the Rapid 45-2 GK and GA 53100 device installation trunking.

Cover

PC/
ABS



Type	Colour	Length mm	Pack m	Weight kg/100 m	Item no.
GKH-OT45RW	Pure white	2000	24	15.900	6114162

Trunking cover for closing the Rapid 45-2 device installation trunking.

Joint cover

PC/
ABS

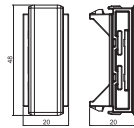

Type	Colour	Pack Piece	Weight kg/100 pc.	Item no.
GK-OTSA45RW	Pure white	6	0.624	6113030

Joint cover for the cover of the Rapid 45-2 device installation trunking to hide cut edges and provide a tidy connection to installed Modul 45® devices.

Partition GKH-TW53

PC/
ABS

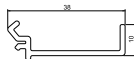

Type	Length mm	Pack m	Weight kg/100 m	Item no.
GKH-TW53	2000	40	14.300	6114166



Rapid 45-2 GA device installation trunking

Installation principle

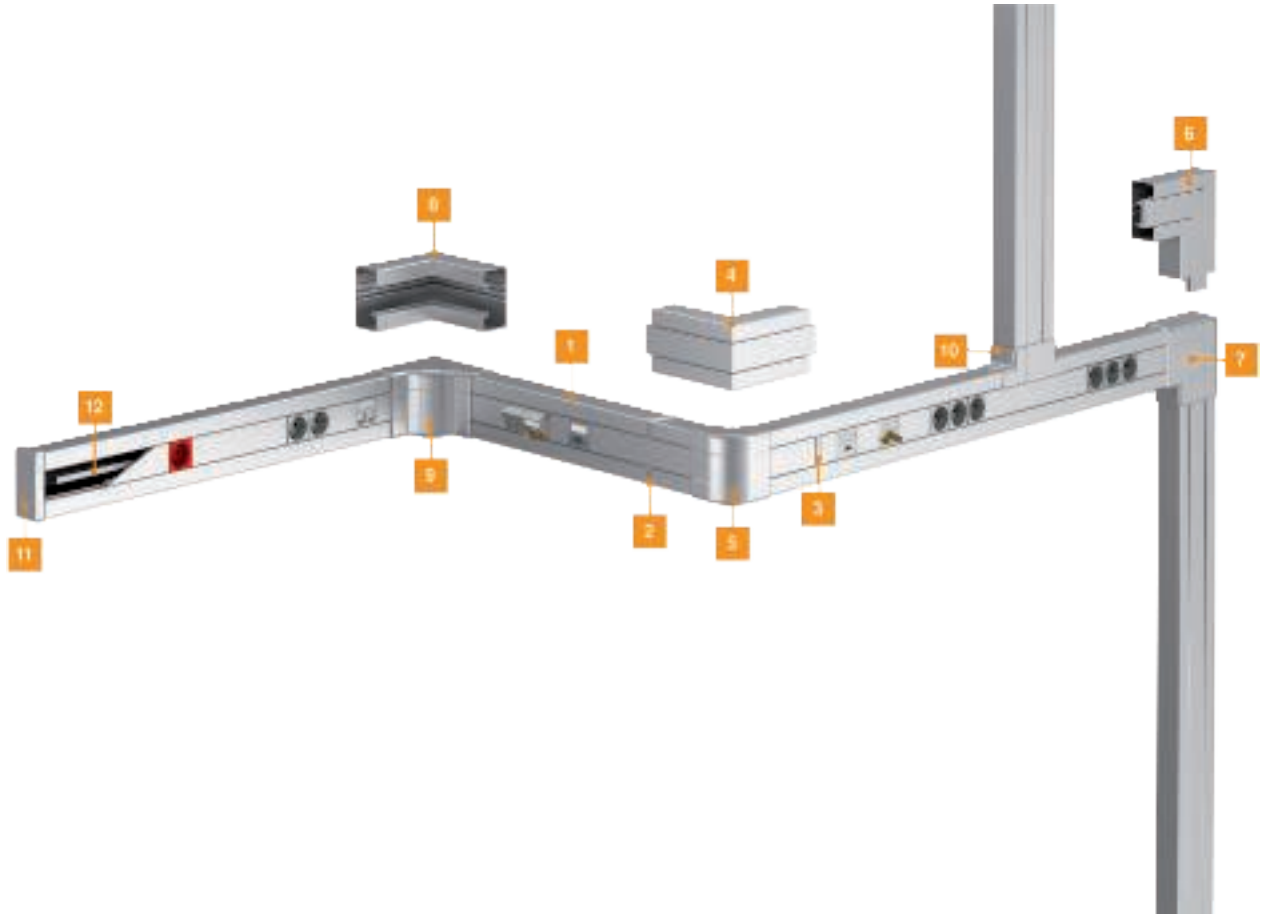

1	Device installation trunking	GA
2	Trunking connector and joint cover	GK-KS
3	Joint cover	
4	External corner	GA-AS
5	External corner cover	GA-AH
6	Flat angle	GA-FS
7	Flat angle cover	GA-FS
8	Internal corner	GA-IS
9	Internal corner cover	GA-IH
10	T piece adapter	GA-TR
11	End piece	GK-E
12	Partition	GK-TW

Alu EL

Device installation trunking Rapid 45-2, trunking width 100, trunking height 53

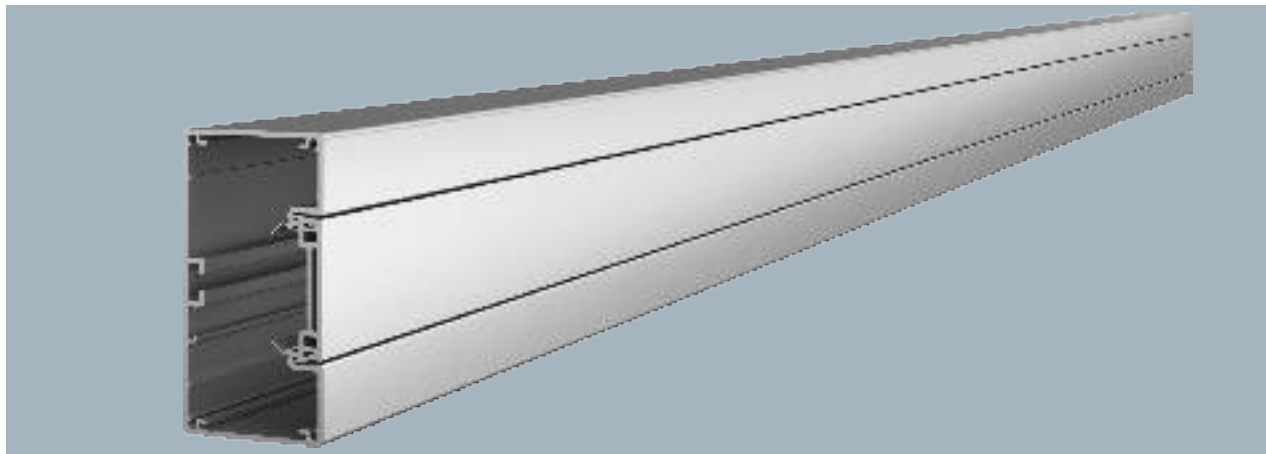

Aluminium complete device installation trunking, consisting of a base and cover. The base has no floor perforation.

Note:

For anodised device installation trunking and fittings made from aluminium, light colour differences caused by permitted scatter due to the material and process conditions cannot be avoided (according to DIN 17 611). 45 mm devices can be clicked in directly. When using PC/ABS hood fittings, there may be colour differences due to the different materials.

Type	Colour	Surface	Length mm	Pack m	Weight kg/100 m	Item no.
GA-53100EL	—	Anodised	2000	8	223.800	6112403
GA-53100RW	Pure white	—	2000	8	223.800	6112400

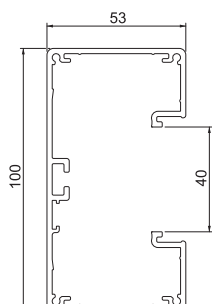

PC/ABS

Trunking connector and joint cover

Type	Colour	Pack Piece	Weight kg/100 pc.	Item no.
GK-KS45-1AL	Aluminium	1	0.580	6113024
GK-KS45-1RW	Pure white	6	0.861	6113020

Joint cover for the bases of the Rapid 45-2 device installation trunking to hide cut edges and provide a perfect connection of the trunking segments. The joint covers are attached. Suitable for trunking width 100 mm and 165 mm.

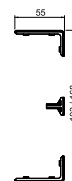

Alu EL

Flat angle, for device installation trunking Rapid 45-2 type GA-53100

Type	Colour	Surface	Pack Piece	Weight kg/100 pc.	Item no.
GA-FS53100EL	—	Anodised	1	69.200	6112443
GA-FS53100RW	Pure white	—	1	69.200	6112440

90° aluminium flat angle for direction change of Rapid 45-2 GA... device installation trunking.

Note:

For anodised device installation trunking and fittings made from aluminium, light colour differences caused by permitted scatter due to the material and process conditions cannot be avoided (according to DIN 17 611). 45 mm devices can be clicked in directly. When using PC/ABS hood fittings, there may be colour differences due to the different materials.

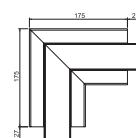

Flat angle, for device installation trunking Rapid 45-2 type GK-53100

PC/ABS

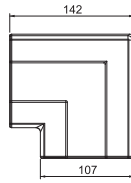

Type	Colour		Pack Piece	Weight kg/100 pc.	Item no.
	Colour	Surface			
GK-FH53100AL	Aluminium		2	9.800	6113094
GK-FH53100RW	Pure white		2	10.911	6113090

Flat angle as hood fitting for changing the direction of the Rapid 45-2 device installation trunking.

Internal corner, for device installation trunking Rapid 45-2 type GA-53100

Alu EL

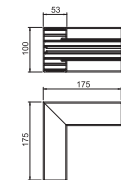

Type	Colour		Surface	Pack Piece	Weight kg/100 pc.	Item no.
	Colour	Surface				
GA-IS53100EL	—	Anodised		1	69.200	6112433
GA-IS53100RW	Pure white	—		1	69.200	6112430

Corner 90° aluminium for changing the direction of device installation trunking Rapid 45-2 GA...

Note:

For anodised device installation trunking and fittings made from aluminium, light colour differences caused by permitted scatter due to the material and process conditions cannot be avoided (according to DIN 17 611). 45 mm devices can be clicked in directly. When using PC/ABS hood fittings, there may be colour differences due to the different materials.

Internal corner, for device installation trunking Rapid 45-2 type GK-53100

PC/ABS

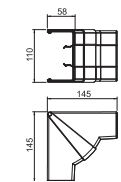

Type	Colour		Pack Piece	Weight kg/100 pc.	Item no.
	Colour	Surface			
GK-IH53100AL	Aluminium		1	12.000	6113074
GK-IH53100RW	Pure white		1	12.856	6113070

Internal corner for changing the direction of Rapid 45 device installation trunking.

External corner, for device installation trunking Rapid 45-2 type GA-53100

Alu EL

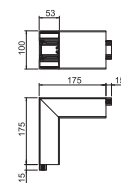

Type	Colour		Surface	Pack Piece	Weight kg/100 pc.	Item no.
	Colour	Surface				
GA-AS53100EL	—	Anodised		1	84.100	6112423
GA-AS53100RW	Pure white	—		1	84.100	6112420

External corner 90° aluminium for changing the direction of device installation trunking Rapid 45-2 GA...

Note:

For anodised device installation trunking and fittings made from aluminium, light colour differences caused by permitted scatter due to the material and process conditions cannot be avoided (according to DIN 17 611). 45 mm devices can be clicked in directly. When using PC/ABS hood fittings, there may be colour differences due to the different materials.

PC / ABS

External corner, for device installation trunking Rapid 45-2 type GK-53100

Type	Colour	Pack Piece	Weight kg/100 pc.	Item no.
GK-AH53100RW	Pure white	1	7.153	6113050
GK-AH53100AL	Aluminium	1	6.900	6113054

External corner for changing the direction of Rapid 45-2 device installation trunking. The fittings can be adjusted between 80–110°.



PC / ABS

T piece adapter, for device installation trunking Rapid 45-2 type GK-53100

Type	Colour	Pack Piece	Weight kg/100 pc.	Item no.
GK-TR53100AL	Aluminium	1	3.405	6113104
GK-TR53100RW	Pure white	1	3.405	6113100

T piece to create a 90° junction of the system size 53100 on the system size 53100.

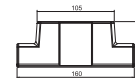

PC / ABS

T piece adapter WDK 40060

Type	Colour	Pack Piece	Weight kg/100 pc.	Item no.
GK-TA WDK 1AL	Aluminium	1	3.002	6113314
GK-TA WDK 1RW	Pure white	1	3.002	6113310

T-piece adapter to create a 90° junction from the system size Rapid 45-2 53100 and 53165 on a cable trunking WDK40060.

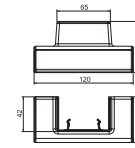

PC / ABS

End piece, for device installation trunking Rapid 45-2 type GK-53100

Type	Colour	Pack Piece	Weight kg/100 pc.	Item no.
GK-E53100RW	Pure white	1	2.493	6113110
GK-E53100AL	Aluminium	1	2.200	6113114

End piece for side closing of the Rapid 45-2 GK and GA 53100 device installation trunking.

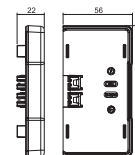

Alu EL

Cover, for device installation trunking Rapid 45-2

Type	Colour	Length mm	Pack m	Weight kg/100 m	Item no.
GA-OT45EL	—	2000	20	47.450	6112413
GA-OT45RW	Pure white	2000	20	47.450	6112410

Trunking cover for closing the device installation trunking of the Rapid 45-2 GA... series. . The 2-piece cover consists of a PVC base profile and an aluminium panel profile.

Note:

For anodised aluminium trunking, covers and fittings, light colour differences caused by permitted scatter due to the material and process conditions cannot be avoided (according to DIN 17 611). 45 mm devices can be clicked in directly. When using PC/ABS hood fittings, there may be colour differences due to the different materials.

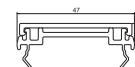

Partition GK-TW53

PVC



Type	Length mm	Pack m	Weight kg/100 m	Item no.
GK-TW53	2000	40	28.700	6113290

Partition for mounting in Rapid 45-2 GK and GA device installation trunking for installing cables of different voltage levels.

Protective conductor connection bracket

St G

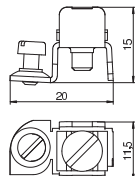

Type	Surface	Pack Piece	Weight kg/100 pc.	Item no.
8AWR	Electrogalvanised	10	0.610	6288704

Protective conductor connection bracket to include steel and aluminium device installation trunking, service poles and system components of underfloor duct systems in the protective measure.
Clamping area: 2 x 1.5–4 mm²

Joint connector

St

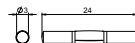

Type	Pack Piece	Weight kg/100 pc.	Item no.
GEK-AKU45	10	0.135	6116752

Joint connectors as notched pins for direct joint-to-joint connection of the trunking bases without joint cover. Suitable for aluminium device installation trunking of the Rapid 80 and Rapid 45-2 series and GAD design trunking for system use for cable routing and/or with Modul45 connect.

Note:

For anodised device installation trunking and fittings made from aluminium, light colour differences caused by permitted scatter due to the material and process conditions cannot be avoided (according to DIN 17 611). mm devices can be clicked in directly. When using PC/ABS hood fittings, there may be colour differences due to the different materials.

Alu EL

Device installation trunking Rapid 45-2, trunking width 130, trunking height 53

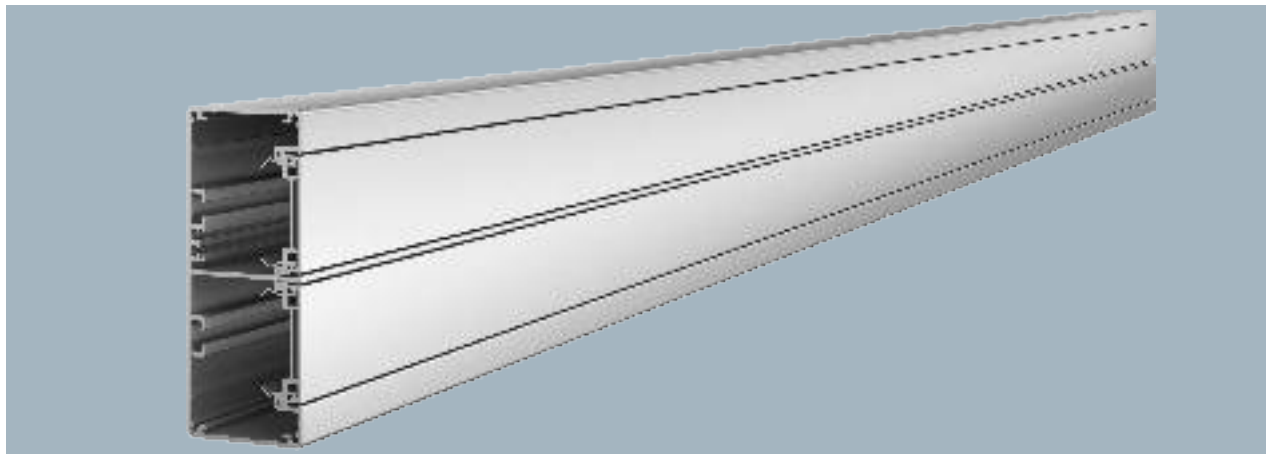

Aluminium complete device installation trunking, consisting of a base and cover. The base has no floor perforation.

Note:

For anodised device installation trunking and fittings made from aluminium, light colour differences caused by permitted scatter due to the material and process conditions cannot be avoided (according to DIN 17 611). 45 mm devices can be clicked in directly. When using PC/ABS hood fittings, there may be colour differences due to the different materials.

Type	Colour	Surface	Length mm	Pack m	Weight kg/100 m	Item no.
GA-53130EL	—	Anodised	2000	8	326.500	6112503
GA-53130RW	Pure white	—	2000	8	326.500	6112500

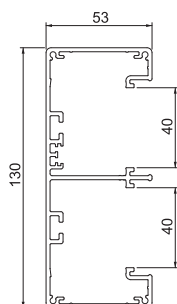

PC/ABS

Trunking connector and joint cover

Type	Colour	Pack Piece	Weight kg/100 pc.	Item no.
GK-KS45-2AL	Aluminium	1	0.450	6113214
GK-KS45-1RW	Pure white	6	0.861	6113020

Joint cover for the bases of the Rapid 45 device installation trunking to hide cut edges and provide a perfect connection of the trunking segments. The joint covers are attached. Suitable for trunking width 130 mm.



Alu EL

Flat angle, for device installation trunking Rapid 45-2 type GA-53130

Type	Colour	Surface	Pack Piece	Weight kg/100 pc.	Item no.
GA-FS53130EL	—	Anodised	1	119.900	6112533
GA-FS53130RW	Pure white	—	1	119.900	6112530

90° aluminium flat angle for direction change of Rapid 45-2 GA... device installation trunking.

Note:

For anodised device installation trunking and fittings made from aluminium, light colour differences caused by permitted scatter due to the material and process conditions cannot be avoided (according to DIN 17 611). 45 mm devices can be clicked in directly. When using PC/ABS hood fittings, there may be colour differences due to the different materials.

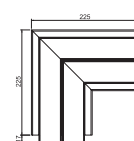

Trunking height 53 mm, trunking width 130 mm

Flat angle, for device installation trunking Rapid 45-2 type GK-53130

PC/ABS

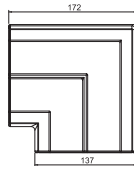

Type	Colour		Pack Piece	Weight kg/100 pc.	Item no.
	Colour	Surface			
GK-FH53130AL	Aluminium		2	12.700	6113274
GK-FH53130RW	Pure white		2	14.754	6113270

Flat angle as hood fitting for changing the direction of the Rapid 45-2 device installation trunking.

Internal corner, for device installation trunking Rapid 45-2 type GA-53100

Alu EL

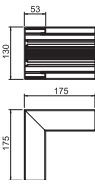
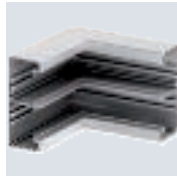

Type	Colour		Surface	Pack Piece	Weight kg/100 pc.	Item no.
	Colour	Surface				
GA-IS53130EL	—	Anodised		1	89.200	6112523
GA-IS53130RW	Pure white	—		1	89.200	6112520

Corner 90° aluminium for changing the direction of device installation trunking Rapid 45-2 GA...

Note:

For anodised device installation trunking and fittings made from aluminium, light colour differences caused by permitted scatter due to the material and process conditions cannot be avoided (according to DIN 17 611). 45 mm devices can be clicked in directly. When using PC/ABS hood fittings, there may be colour differences due to the different materials.

Internal corner, for Rapid 45-2 device installation trunking, type GK-53130

PC/ABS

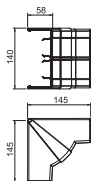

Type	Colour		Pack Piece	Weight kg/100 pc.	Item no.
	Colour	Surface			
GK-IH53130AL	Aluminium		1	13.170	6113254
GK-IH53130RW	Pure white		1	14.730	6113250

Internal corner for changing the direction of Rapid 45 device installation trunking.

External corner, for device installation trunking Rapid 45-2 type GA-53130

Alu EL

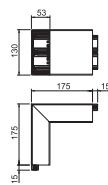

Type	Colour		Surface	Pack Piece	Weight kg/100 pc.	Item no.
	Colour	Surface				
GA-AS53130EL	—	Anodised		1	117.700	6112513
GA-AS53130RW	Pure white	—		1	117.700	6112510

External corner 90° aluminium for changing the direction of device installation trunking Rapid 45-2 GA...

Note:

For anodised device installation trunking and fittings made from aluminium, light colour differences caused by permitted scatter due to the material and process conditions cannot be avoided (according to DIN 17 611). 45 mm devices can be clicked in directly. When using PC/ABS hood fittings, there may be colour differences due to the different materials.

PC / ABS

External corner cover

Type	Colour	Pack Piece	Weight kg/100 pc.	Item no.
GK-AH53130RW	Pure white	1	8.440	6113230
GK-AH53130AL	Aluminium	1	8.000	6113234

External corner for changing the direction of Rapid 45-2 device installation trunking. The fittings can be adjusted between 80–110°.



PC / ABS

T piece adapter, for device installation trunking Rapid 45-2 type GK-53130

Type	Colour	Pack Piece	Weight kg/100 pc.	Item no.
GK-TR53130AL	Aluminium	1	3.514	6113304
GK-TR53130RW	Pure white	1	3.514	6113300

T piece adapter to create a 90° junction of the system size 53130 on the system size 53130.

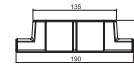

PC / ABS

T piece adapter on WDK 40060

Type	Colour	Pack Piece	Weight kg/100 pc.	Item no.
GK-TA WDK 2AL	Aluminium	1	2.200	6113324
GK-TA WDK 2RW	Pure white	1	2.717	6113320

T-piece adapter to create a 90° junction from the system size Rapid 45-2 53130 to a cable trunking WDK40060.

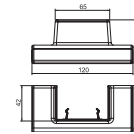

PC / ABS

End piece, for device installation trunking Rapid 45-2 type GK-53130

Type	Colour	Pack Piece	Weight kg/100 pc.	Item no.
GK-E53130AL	Aluminium	1	2.700	6113284
GK-E53130RW	Pure white	1	2.972	6113280

End piece for side closing of the Rapid 45-2 GK and GA 53130 device installation trunking.

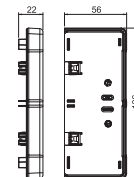

Alu EL

Cover, for device installation trunking Rapid 45-2

Type	Colour	Length mm	Pack m	Weight kg/100 m	Item no.
GA-OT45EL	—	2000	20	47.450	6112413
GA-OT45RW	Pure white	2000	20	47.450	6112410

Trunking cover for closing the device installation trunking of the Rapid 45-2 GA... series. . The 2-piece cover consists of a PVC base profile and an aluminium panel profile.

Note:

For anodised aluminium trunking, covers and fittings, light colour differences caused by permitted scatter due to the material and process conditions cannot be avoided (according to DIN 17 611). 45 mm devices can be clicked in directly. When using PC/ABS hood fittings, there may be colour differences due to the different materials.

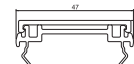

Partition GK-TW53

PVC



Type	Length mm	Pack m	Weight kg/100 m	Item no.
GK-TW53	2000	40	28.700	6113290

Partition for mounting in Rapid 45-2 GK and GA device installation trunking for installing cables of different voltage levels.

Protective conductor connection bracket

St G

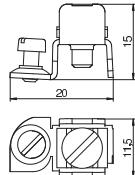

Type	Surface	Pack Piece	Weight kg/100 pc.	Item no.
8AWR	Electrogalvanised	10	0.610	6288704

Protective conductor connection bracket to include steel and aluminium device installation trunking, service poles and system components of underfloor duct systems in the protective measure.
Clamping area: 2 x 1.5–4 mm²

Joint connector

St



Type	Pack Piece	Weight kg/100 pc.	Item no.
GEK-AKU45	10	0.135	6116752

Joint connectors as notched pins for direct joint-to-joint connection of the trunking bases without joint cover. Suitable for aluminium device installation trunking of the Rapid 80 and Rapid 45-2 series and GAD design trunking for system use for cable routing and/or with Modul45 connect.

Note:

For anodised device installation trunking and fittings made from aluminium, light colour differences caused by permitted scatter due to the material and process conditions cannot be avoided (according to DIN 17 611). mm devices can be clicked in directly. When using PC/ABS hood fittings, there may be colour differences due to the different materials.

Alu EL

Device installation trunking Rapid 45-2, trunking width 165, trunking height 53

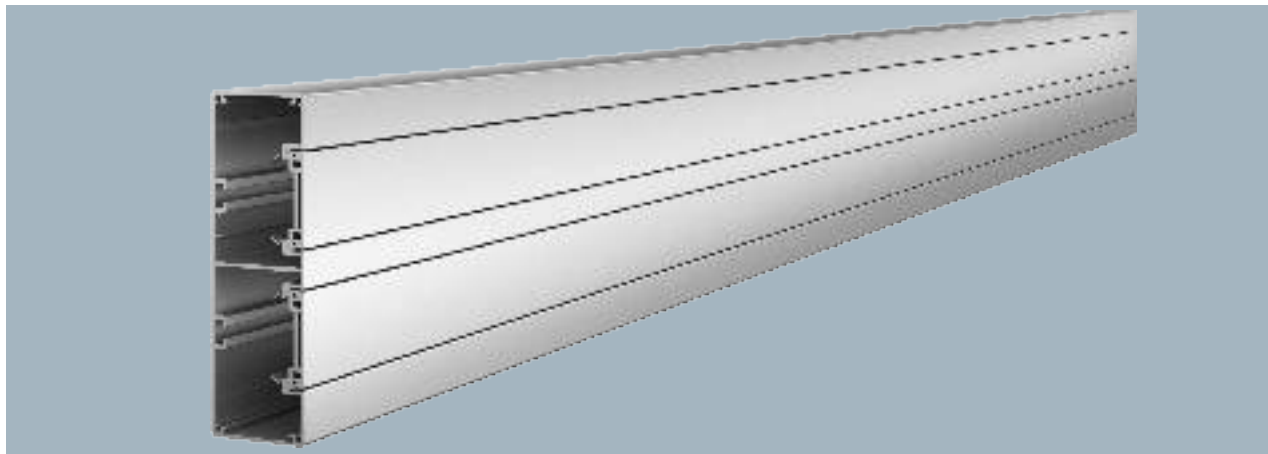

Aluminium complete device installation trunking, consisting of a base and cover. The base has no floor perforation.

Note:

For anodised device installation trunking and fittings made from aluminium, light colour differences caused by permitted scatter due to the material and process conditions cannot be avoided (according to DIN 17 611). 45 mm devices can be clicked in directly. When using PC/ABS hood fittings, there may be colour differences due to the different materials.

Type	Colour	Surface	Length mm	Pack m	Weight kg/100 m	Item no.
GA-53165EL	—	Anodised	2000	6	370.750	6112603
GA-53165RW	Pure white	—	2000	6	370.750	6112600

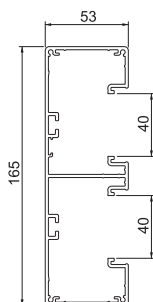

PC/ABS

Trunking connector and joint cover

Type	Colour	Pack Piece	Weight kg/100 pc.	Item no.
GK-KS45-1AL	Aluminium	1	0.580	6113024
GK-KS45-1RW	Pure white	6	0.861	6113020

Joint cover for the bases of the Rapid 45-2 device installation trunking to hide cut edges and provide a perfect connection of the trunking segments. The joint covers are attached. Suitable for trunking width 100 mm and 165 mm.

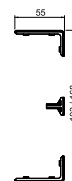

Alu EL

Flat angle, for device installation trunking Rapid 45-2 type GA-53165

Type	Colour	Surface	Pack Piece	Weight kg/100 pc.	Item no.
GA-FS53165EL	—	Anodised	1	121.900	6112633
GA-FS53165RW	Pure white	—	1	121.900	6112630

90° aluminium flat angle for direction change of Rapid 45-2 GA... device installation trunking.

Note:

For anodised device installation trunking and fittings made from aluminium, light colour differences caused by permitted scatter due to the material and process conditions cannot be avoided (according to DIN 17 611). 45 mm devices can be clicked in directly. When using PC/ABS hood fittings, there may be colour differences due to the different materials.

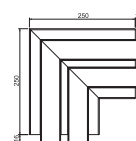

Flat angle, for device installation trunking Rapid 45-2 type GK-53165

PC/ABS

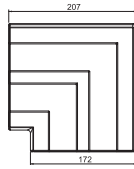

Type	Colour		Pack Piece	Weight kg/100 pc.	Item no.
	Colour	Surface			
GK-FH53165AL	Aluminium		2	16.300	6113464
GK-FH53165RW	Pure white		2	16.300	6113460

Flat angle as hood fitting for changing the direction of the Rapid 45-2 device installation trunking.

Internal corner, for device installation trunking Rapid 45-2 type GA-53165

Alu EL

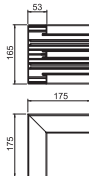

Type	Colour		Surface	Pack Piece	Weight kg/100 pc.	Item no.
	Colour	Surface				
GA-IS53165EL	—	Anodised		1	100.100	6112623
GA-IS53165RW	Pure white	—		1	100.100	6112620

Corner 90° aluminium for changing the direction of device installation trunking Rapid 45-2 GA...

Note:

For anodised device installation trunking and fittings made from aluminium, light colour differences caused by permitted scatter due to the material and process conditions cannot be avoided (according to DIN 17 611). 45 mm devices can be clicked in directly. When using PC/ABS hood fittings, there may be colour differences due to the different materials.

Internal corner, for Rapid 45-2 device installation trunking, type GK-53165

PC/ABS

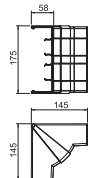

Type	Colour		Pack Piece	Weight kg/100 pc.	Item no.
	Colour	Surface			
GK-IH53165AL	Aluminium		1	14.660	6113444
GK-IH53165RW	Pure white		1	15.634	6113440

Internal corner for changing the direction of Rapid 45 device installation trunking.

External corner, for device installation trunking Rapid 45-2 type GA-53165

Alu EL

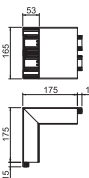

Type	Colour		Surface	Pack Piece	Weight kg/100 pc.	Item no.
	Colour	Surface				
GA-AS53165EL	—	Anodised		1	114.200	6112613
GA-AS53165RW	Pure white	—		1	114.200	6112610

External corner 90° aluminium for changing the direction of device installation trunking Rapid 45-2 GA...

Note:

For anodised device installation trunking and fittings made from aluminium, light colour differences caused by permitted scatter due to the material and process conditions cannot be avoided (according to DIN 17 611). 45 mm devices can be clicked in directly. When using PC/ABS hood fittings, there may be colour differences due to the different materials.

PC / ABS

External corner, for device installation trunking Rapid 45-2 type GK-53165

Type	Colour	Pack Piece	Weight kg/100 pc.	Item no.
GK-AH53165AL	Aluminium	1	9.230	6113424
GK-AH53165RW	Pure white	1	9.230	6113420

External corner for changing the direction of Rapid 45-2 device installation trunking. The fittings can be adjusted between 80–110°.



PC / ABS

T piece adapter, for device installation trunking Rapid 45-2 type GK-53165

Type	Colour	Pack Piece	Weight kg/100 pc.	Item no.
GK-TR53165AL	Aluminium	1	4.040	6113484
GK-TR53165RW	Pure white	1	4.545	6113480

T-piece adapter to create a 90° junction of the system size 53165 on the system size 53165.

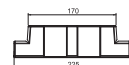

PC / ABS

T piece adapter WDK 40060

Type	Colour	Pack Piece	Weight kg/100 pc.	Item no.
GK-TA WDK 1AL	Aluminium	1	3.002	6113314
GK-TA WDK 1RW	Pure white	1	3.002	6113310

T-piece adapter to create a 90° junction from the system size Rapid 45-2 53100 and 53165 on a cable trunking WDK40060.

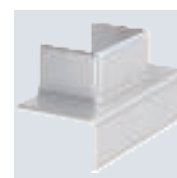
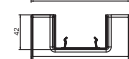
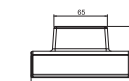

PC / ABS

End piece, for device installation trunking Rapid 45-2 type GK-53165

Type	Colour	Pack Piece	Weight kg/100 pc.	Item no.
GK-E53165AL	Aluminium	1	3.240	6113474
GK-E53165RW	Pure white	1	3.561	6113470

End piece for side closing of the Rapid 45-2 GK and GA 53165 device installation trunking.

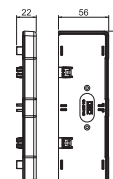

Alu EL

Cover, for device installation trunking Rapid 45-2

Type	Colour	Length mm	Pack m	Weight kg/100 m	Item no.
GA-OT45EL	—	2000	20	47.450	6112413
GA-OT45RW	Pure white	2000	20	47.450	6112410

Trunking cover for closing the device installation trunking of the Rapid 45-2 GA... series. . The 2-piece cover consists of a PVC base profile and an aluminium panel profile.

Note:

For anodised aluminium trunking, covers and fittings, light colour differences caused by permitted scatter due to the material and process conditions cannot be avoided (according to DIN 17 611). 45 mm devices can be clicked in directly. When using PC/ABS hood fittings, there may be colour differences due to the different materials.

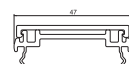

Partition GK-TW53

PVC



Type	Length mm	Pack m	Weight kg/100 m	Item no.
GK-TW53	2000	40	28.700	6113290

Partition for mounting in Rapid 45-2 GK and GA device installation trunking for installing cables of different voltage levels.

Protective conductor connection bracket

St G

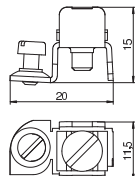

Type	Surface	Pack Piece	Weight kg/100 pc.	Item no.
8AWR	Electrogalvanised	10	0.610	6288704

Protective conductor connection bracket to include steel and aluminium device installation trunking, service poles and system components of underfloor duct systems in the protective measure.
Clamping area: 2 x 1.5–4 mm²

Joint connector

St

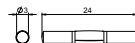

Type	Pack Piece	Weight kg/100 pc.	Item no.
GEK-AKU45	10	0.135	6116752

Joint connectors as notched pins for direct joint-to-joint connection of the trunking bases without joint cover. Suitable for aluminium device installation trunking of the Rapid 80 and Rapid 45-2 series and GAD design trunking for system use for cable routing and/or with Modul45 connect.

Note:

For anodised device installation trunking and fittings made from aluminium, light colour differences caused by permitted scatter due to the material and process conditions cannot be avoided (according to DIN 17 611). mm devices can be clicked in directly. When using PC/ABS hood fittings, there may be colour differences due to the different materials.



Cover, for device installation trunking Rapid 45-2

PVC

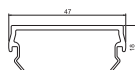

Type	Colour	Length mm	Pack	Weight	Item no.
			m	kg/100 m	
GK-OT45RW	Pure white	2000	24	20.550	6113010

Trunking cover for closing the Rapid 45-2 device installation trunking.

Cover, for device installation trunking Rapid 45-2

PVC

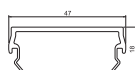

Type	Colour	Length mm	Pack	Weight	Item no.
			m	kg/100 m	
GK-OT45LGR	Light grey	2000	24	20.550	6113012

Trunking cover for closing the Rapid 45-2 device installation trunking.

Cover, for device installation trunking Rapid 45-2

Alu

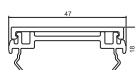

Type	Colour	Length mm	Pack	Weight	Item no.
			m	kg/100 m	
GA-OT45RW	Pure white	2000	20	47.450	6112410

Trunking cover for closing the device installation trunking of the Rapid 45-2 GA... series. . The 2-piece cover consists of a PVC base profile and an aluminium panel profile.

Note:

For anodised aluminium trunking, covers and fittings, light colour differences caused by permitted scatter due to the material and process conditions cannot be avoided (according to DIN 17 611). 45 mm devices can be clicked in directly. When using PC/ABS hood fittings, there may be colour differences due to the different materials.

Cover, for device installation trunking Rapid 45-2

Alu EL

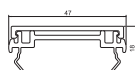

Type	Colour	Length mm	Pack	Weight	Item no.
			m	kg/100 m	
GA-OT45EL	—	2000	20	47.450	6112413

Trunking cover for closing the device installation trunking of the Rapid 45-2 GA... series. . The 2-piece cover consists of a PVC base profile and an aluminium panel profile.

Note:

For anodised aluminium trunking, covers and fittings, light colour differences caused by permitted scatter due to the material and process conditions cannot be avoided (according to DIN 17 611). 45 mm devices can be clicked in directly. When using PC/ABS hood fittings, there may be colour differences due to the different materials.



Trunking height 70 mm, trunking width 110 mm

PVC

Device installation trunking Rapid 80, trunking width 110, trunking height 70

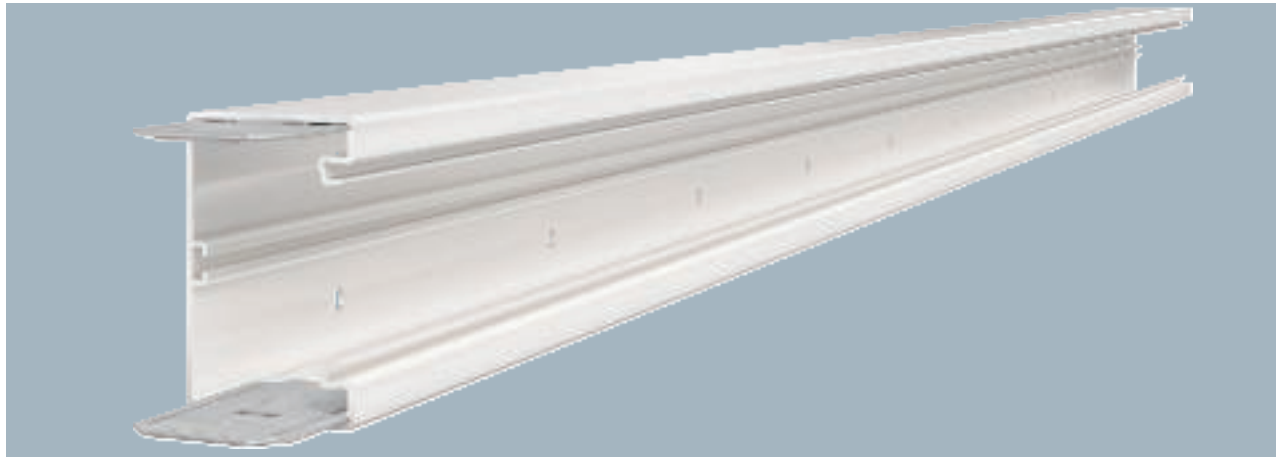

Type	Colour	Length mm	Pack m	Weight kg/100 m	Item no.
GK-70110RW	Pure white	2000	8	132.000	6274300
GK-70110CW	Cream	2000	8	132.000	6274301
GK-70110LGR	Light grey	2000	8	132.000	6274302
GK-70110GR	Stone grey	2000	8	132.000	6274306

GK device installation trunking, made of lead-free PVC, suitable for installing directly on the wall or on wall panels. Fastening takes place using the perforation in the trunking. The GK device installation trunking possesses a C profile on the floor to accept a plastic partition. All the switch programmes with a support ring and support clamp design as well as Modul 45 installation devices can be installed in the accessory mounting boxes of series 71GD.... The system opening is 76.5 mm. On each trunking length, a coupling pair is pre-assembled on one side. The cover must be ordered separately.

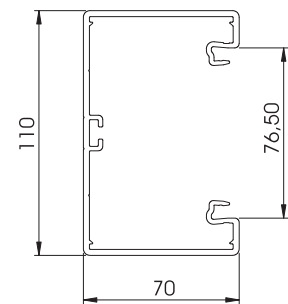

Accessory mounting box 71GD6, single

PA

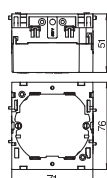

Type	Colour	Pack Piece	Weight kg/100 pc.	Item no.
71GD6	Iron grey	5	5.600	6288610

Front locking accessory mounting box for switch systems, with folding, and also removable, base for time-saving cable connection, with feed openings for cable diameters of up to 14 mm. Halogen-free version.

7ZE strain relief

PA

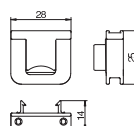

Type	Pack Piece	Weight kg/100 pc.	Item no.
7ZE	50	0.700	6288790

Strain relief with locking clips, suitable for the accessory mounting boxes 7GD... and 71GD... Cable clamping range to 14 mm.

PVC

Plastic trunking cover, smooth

Type	Colour	Length mm	Pack m	Weight kg/100 m	Item no.
GK-OTGRW	Pure white	2000	16	27.500	6278680
GK-OTGCW	Cream	2000	16	27.500	6278681
GK-OTGLGR	Light grey	2000	16	27.500	6278682
GK-OTGGR	Stone grey	2000	16	27.500	6278686

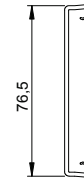

Smooth trunking cover, for closing device installation trunking with 76.5 mm system opening.

PC / ABS



External corner hood, for Rapid 80 device installation trunking, type GK-70110

Type	Colour	Length mm	Pack Piece	Weight kg/100 pc.	Item no.
GK-AH70110RW	Pure white	130.5	1	15.000	6274210
GK-AH70110CW	Cream	130.5	1	15.000	6274211
GK-AH70110LGR	Light grey	130.5	1	15.000	6274212

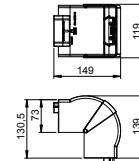

External corner cover made of halogen-free PC/ABS for changing the direction of Rapid 80 device installation trunking of the GK, GKH, GS and GA systems. The fittings can be variably adjusted between 80° and 100° and can be used in symmetrical and asymmetrical trunking.

PVC

External corner, for device installation trunking Rapid 80 type GK-70110

Type	Colour	Pack Piece	Weight kg/100 pc.	Item no.
GK-A70110RW	Pure white	1	116.000	6274310
GK-A70110CW	Cream	1	116.000	6274311
GK-A70110LGR	Light grey	1	116.000	6274312
GK-A70110GR	Stone grey	1	116.000	6274316

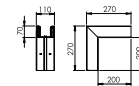

External corner for changing the direction of the GK device installation trunking.
Cover must be ordered separately.

PVC

External corner cover, smooth

Type	Colour	Pack Piece	Weight kg/100 pc.	Item no.
GK-OTGARW	Pure white	2	9.500	6274790
GK-OTGACW	Cream	2	9.500	6274791
GK-OTGALGR	Light grey	2	9.500	6274792
GK-OTGAGR	Stone grey	2	9.500	6274796

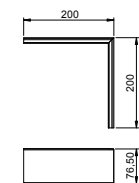

PVC external corner cover, smooth surface.

PC / ABS



Flat angle cover, for device installation trunking Rapid 80 type GK-70110

Type	Colour	Length mm	Pack Piece	Weight kg/100 pc.	Item no.
GK-FH70110RW	Pure white	152.5	1	15.100	6274220
GK-FH70110CW	Cream	152.5	1	15.100	6274221
GK-FH70110LGR	Light grey	152.5	1	15.100	6274222

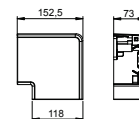

Flat angle cover fitting made of halogen-free PC/ABS for simple creation of a rising or falling 90° change of direction with device installation trunking of the series Rapid 80 GK, GKH, GS and GA. The flat angle cover fitting can be used for symmetrical and asymmetrical trunking types.

Flat angle, for device installation trunking Rapid 80 type GK-70110

PVC

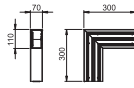

Type	Colour	Pack Piece	Weight kg/100 pc.	Item no.
GK-F70110RW	Pure white	1	78.000	6274320
GK-F70110CW	Cream	1	78.000	6274321
GK-F70110LGR	Light grey	1	78.000	6274322
GK-F70110GR	Stone grey	1	78.000	6274326

Flat angle for changing the direction of the GK device installation trunking.
Cover must be ordered separately.

Flat angle cover, smooth

PVC

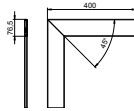

Type	Colour	Pack Piece	Weight kg/100 pc.	Item no.
GK-OTGFRW	Pure white	1	17.000	6274490
GK-OTGFCW	Cream	1	17.000	6274491
GK-OTGFLGR	Light grey	1	17.000	6274492
GK-OTGFGFR	Stone grey	1	17.000	6274496

PVC flat angle cover, smooth surface.

Internal corner hood, for Rapid 80 device installation trunking, type GK-70110

PC/ABS

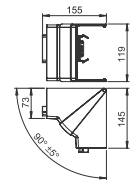

Type	Colour	Pack Piece	Weight kg/100 pc.	Item no.
GK-IH70110RW	Pure white	1	14.200	6274240
GK-IH70110CW	Cream	1	14.200	6274241
GK-IH70110LGR	Light grey	1	14.200	6274282

Internal corner cover made of halogen-free PC/ABS for changing the direction of Rapid 80 device installation trunking of the GK, GKH, GS and GA systems. The fittings can be variably adjusted between 85° and 95° and can be used in symmetrical and asymmetrical trunking.

Internal corner, for device installation trunking Rapid 80 type GK-70110

PVC

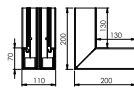

Type	Colour	Pack Piece	Weight kg/100 pc.	Item no.
GK-I70110RW	Pure white	1	100.000	6274340
GK-I70110CW	Cream	1	100.000	6274341
GK-I70110LGR	Light grey	1	100.000	6274342
GK-I70110GR	Stone grey	1	100.000	6274346

Internal corner for changing the direction of the GK device installation trunking.

T piece, for device installation trunking Rapid 80 type GK-70110

PVC

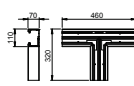

Type	Colour	Pack Piece	Weight kg/100 pc.	Item no.
GK-T70110RW	Pure white	1	100.000	6274360
GK-T70110CW	Cream	1	100.000	6274361
GK-T70110LGR	Light grey	1	100.000	6274362
GK-T70110GR	Stone grey	1	100.000	6274366

T piece for changing the direction of the GK device installation trunking.

PVC

End piece, for device installation trunking Rapid 80 type GK-70110

Type	Colour	Pack Piece	Weight kg/100 pc.	Item no.
GK-E70110RW	Pure white	1	5.009	6274370
GK-E70110CW	Cream	1	5.009	6274371
GK-E70110LGR	Light grey	1	5.009	6274372
GK-E70110GR	Stone grey	1	5.009	6274376

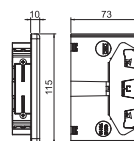

End piece for closing the GK device installation trunking.

PVC

Partition GK-TW70

Type	Length mm	Pack m	Weight kg/100 m	Item no.
GK-TW70	2000	40	17.400	6274900



Partition for mounting in Rapid 80 GK, GA and Rapid IBIS device installation duct or ISS service poles for installing cables of different voltage levels.

PC / ABS

Duct clamp KL80A

Type	Colour	Pack Piece	Weight kg/100 pc.	Item no.
KL80A	Light grey	20	0.685	6288640



Duct clamp for holding cables securely and for fastening the partition in Rapid 80 GK, GS and GA device installation trunking systems as well as in ISS service poles with a 76.5 mm system opening.

Trunking height 70 mm, trunking width 130 mm

PVC

Device installation trunking Rapid 80, trunking width 130, trunking height 70



Type	Colour	Length mm	Pack m	Weight kg/100 m	Item no.
GK-70130RW	Pure white	2000	8	152.000	6274500
GK-70130LGR	Light grey	2000	8	152.000	6274502
GK-70130GR	Stone grey	2000	8	152.000	6274506

GK device installation trunking, made of lead-free PVC, suitable for installing directly on the wall or on wall panels. Fastening takes place using the perforation in the trunking. The GK device installation trunking possesses a C profile on the floor to accept a plastic partition. All the switch programmes with a support ring and support clamp design as well as Modul 45 installation devices can be installed in the accessory mounting boxes of series 71GD.... The system opening is 76.5 mm. On each trunking length, a coupling pair is pre-assembled on one side. The cover must be ordered separately.

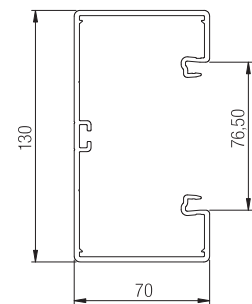

Accessory mounting box 71GD6, single

PA

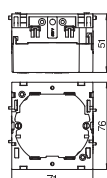

Type	Colour	Pack Piece	Weight kg/100 pc.	Item no.
71GD6	Iron grey	5	5.600	6288610

Front locking accessory mounting box for switch systems, with folding, and also removable, base for time-saving cable connection, with feed openings for cable diameters of up to 14 mm. Halogen-free version.

7ZE strain relief

PA

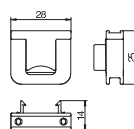

Type	Pack Piece	Weight kg/100 pc.	Item no.
7ZE	50	0.700	6288790

Strain relief with locking clips, suitable for the accessory mounting boxes 7GD... and 71GD... Cable clamping range to 14 mm.

PVC

Plastic trunking cover, smooth

Type	Colour	Length mm	Pack m	Weight kg/100 m	Item no.
GK-OTGRW	Pure white	2000	16	27.500	6278680
GK-OTGCW	Cream	2000	16	27.500	6278681
GK-OTGLGR	Light grey	2000	16	27.500	6278682
GK-OTGGR	Stone grey	2000	16	27.500	6278686

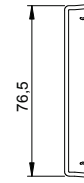

Smooth trunking cover, for closing device installation trunking with 76.5 mm system opening.

PC / ABS



External corner cover, for device installation trunking Rapid 80 type GK-70130

Type	Colour	Length mm	Pack Piece	Weight kg/100 pc.	Item no.
GK-AH70130RW	Pure white	130.5	1	18.535	6274410
GK-AH70130CW	Cream	130.5	1	16.100	6274411
GK-AH70130LGR	Light grey	130.5	1	16.100	6274412

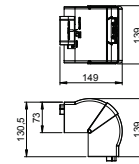

External corner cover made of halogen-free PC/ABS for changing the direction of Rapid 80 device installation trunking of the GK, GKH, GS and GA systems. The fittings can be variably adjusted between 80° and 100° and can be used in symmetrical and asymmetrical trunking.

PVC

External corner, for device installation trunking Rapid 80 type GK-70130

Type	Colour	Pack Piece	Weight kg/100 pc.	Item no.
GK-A70130RW	Pure white	1	127.000	6274510
GK-A70130CW	Cream	1	127.000	6274511
GK-A70130LGR	Light grey	1	127.000	6274512
GK-A70130GR	Stone grey	1	127.000	6274516

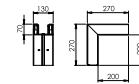

External corner for changing the direction of the GK device installation trunking.
Cover must be ordered separately.

PVC

External corner cover, smooth

Type	Colour	Pack Piece	Weight kg/100 pc.	Item no.
GK-OTGARW	Pure white	2	9.500	6274790
GK-OTGACW	Cream	2	9.500	6274791
GK-OTGALGR	Light grey	2	9.500	6274792
GK-OTGAGR	Stone grey	2	9.500	6274796

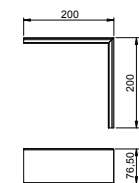

PVC external corner cover, smooth surface.

PC / ABS



Flat angle cover, for device installation trunking Rapid 80 type GK-70130

Type	Colour	Length mm	Pack Piece	Weight kg/100 pc.	Item no.
GK-FH70130RW	Pure white	172.5	1	12.461	6274420
GK-FH70130CW	Cream	172.5	1	17.100	6274421
GK-FH70130LGR	Light grey	172.5	1	17.100	6274422

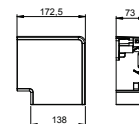

Flat angle cover fitting made of halogen-free PC/ABS for simple creation of a rising or falling 90° change of direction with device installation trunking of the series Rapid 80 GK, GKH, GS and GA. The flat angle cover fitting can be used for symmetrical and asymmetrical trunking types.

PVC

Flat angle, for device installation trunking Rapid 80 type GK-70130

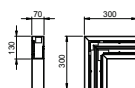

Type	Colour	Pack Piece	Weight kg/100 pc.	Item no.
GK-F70130RW	Pure white	1	83.000	6274520
GK-F70130CW	Cream	1	83.000	6274521
GK-F70130LGR	Light grey	1	83.000	6274522
GK-F70130GR	Stone grey	1	83.000	6274526

Flat angle for changing the direction of the GK device installation trunking.

Flat angle cover, smooth

PVC

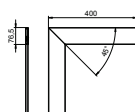

Type	Colour	Pack Piece	Weight kg/100 pc.	Item no.
GK-OTGFRW	Pure white	1	17.000	6274490
GK-OTGFCW	Cream	1	17.000	6274491
GK-OTGFLGR	Light grey	1	17.000	6274492
GK-OTGFGR	Stone grey	1	17.000	6274496

PVC flat angle cover, smooth surface.

Internal corner cover, for device installation trunking Rapid 80 type GK-70130

PC / ABS

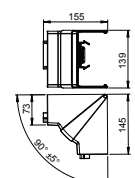

Type	Colour	Pack Piece	Weight kg/100 pc.	Item no.
GK-IH70130RW	Pure white	1	14.900	6274440
GK-IH70130CW	Cream	1	14.900	6274441
GK-IH70130LGR	Light grey	1	14.900	6274442

Internal corner cover made of halogen-free PC/ABS for changing the direction of Rapid 80 device installation trunking of the GK, GKH, GS and GA systems. The fittings can be variably adjusted between 85° and 95° and can be used in symmetrical and asymmetrical trunking.

Internal corner, for device installation trunking Rapid 80 type GK-70130

PVC

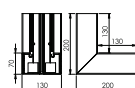

Type	Colour	Pack Piece	Weight kg/100 pc.	Item no.
GK-I70130RW	Pure white	1	110.000	6274540
GK-I70130CW	Cream	1	110.000	6274541
GK-I70130LGR	Light grey	1	110.000	6274542
GK-I70130GR	Stone grey	1	110.000	6274546

Internal corner for changing the direction of the GK device installation trunking.

T piece, for device installation trunking Rapid 80 type GK-70130

PVC

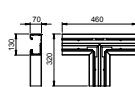

Type	Colour	Pack Piece	Weight kg/100 pc.	Item no.
GK-T70130RW	Pure white	1	108.000	6274560
GK-T70130CW	Cream	1	108.000	6274561
GK-T70130LGR	Light grey	1	108.000	6274562
GK-T70130GR	Stone grey	1	108.000	6274566

T piece for changing the direction of the GK device installation trunking.

PVC

End piece, for device installation trunking Rapid 80 type GK-70130

Type	Colour	Pack Piece	Weight kg/100 pc.	Item no.
GK-E70130RW	Pure white	1	5.574	6274570
GK-E70130CW	Cream	1	5.621	6274571
GK-E70130LGR	Light grey	1	5.621	6274572
GK-E70130GR	Stone grey	1	5.621	6274576

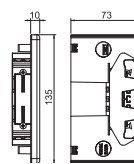

End piece for closing the GK device installation trunking.

PVC

Partition GK-TW70

Type	Length mm	Pack m	Weight kg/100 m	Item no.
GK-TW70	2000	40	17.400	6274900

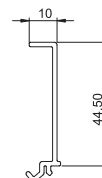

Partition for mounting in Rapid 80 GK, GA and Rapid IBIS device installation duct or ISS service poles for installing cables of different voltage levels.

PC / ABS

Duct clamp KL80A

Type	Colour	Pack Piece	Weight kg/100 pc.	Item no.
KL80A	Light grey	20	0.685	6288640



Duct clamp for holding cables securely and for fastening the partition in Rapid 80 GK, GS and GA device installation trunking systems as well as in ISS service poles with a 76.5 mm system opening.

Trunking height 70 mm, trunking width 170 mm

PVC

Device installation trunking Rapid 80, trunking width 170, trunking height 70



Type	Colour	Length mm	Pack m	Weight kg/100 m	Item no.
GK-70170RW	Pure white	2000	8	180.000	6274700
GK-70170CW	Cream	2000	8	180.000	6274701
GK-70170LGR	Light grey	2000	8	180.000	6274702
GK-70170GR	Stone grey	2000	8	180.000	6274706

GK device installation trunking, made of lead-free PVC, suitable for installing directly on the wall or on wall panels. Fastening takes place using the perforation in the trunking. The GK device installation trunking possesses a C profile on the floor to accept a plastic partition. All the switch programmes with a support ring and support clamp design as well as Modul 45 installation devices can be installed in the accessory mounting boxes of series 71GD.... The system opening is 76.5 mm. On each trunking length, a coupling pair is pre-assembled on one side. The cover must be ordered separately.

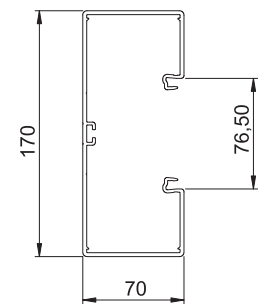

Accessory mounting box 71GD6, single

PA

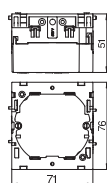

Type	Colour	Pack Piece	Weight kg/100 pc.	Item no.
71GD6	Iron grey	5	5.600	6288610

Front locking accessory mounting box for switch systems, with folding, and also removable, base for time-saving cable connection, with feed openings for cable diameters of up to 14 mm. Halogen-free version.

PA

7ZE strain relief

Type	Pack Piece	Weight kg/100 pc.	Item no.
7ZE	50	0.700	6288790

Strain relief with locking clips, suitable for the accessory mounting boxes 7GD... and 71GD...

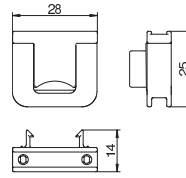

PVC

Plastic trunking cover, smooth

Type	Colour	Length mm	Pack m	Weight kg/100 m	Item no.
GK-OTGRW	Pure white	2000	16	27.500	6278680
GK-OTGCW	Cream	2000	16	27.500	6278681
GK-OTGLGR	Light grey	2000	16	27.500	6278682
GK-OTGGR	Stone grey	2000	16	27.500	6278686

Smooth trunking cover, for closing device installation trunking with 76.5 mm system opening.

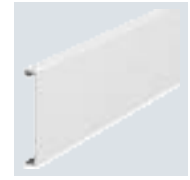

PC / ABS



External corner cover, for device installation trunking Rapid 80 type GK-70170

Type	Colour	Length mm	Pack Piece	Weight kg/100 pc.	Item no.
GK-AH70170RW	Pure white	130.5	1	20.490	6274610
GK-AH70170CW	Cream	130.5	1	20.490	6274611
GK-AH70170LGR	Light grey	130.5	1	20.490	6274612

External corner cover made of halogen-free PC/ABS for changing the direction of Rapid 80 device installation trunking of the GK, GKX, GS and GA systems. The fittings can be variably adjusted between 80° and 100° and can be used in symmetrical and asymmetrical trunking.

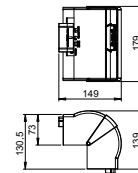

PVC

External corner, for device installation trunking Rapid 80 type GK-70170

Type	Colour	Pack Piece	Weight kg/100 pc.	Item no.
GK-A70170RW	Pure white	1	149.000	6274710
GK-A70170CW	Cream	1	149.000	6274711
GK-A70170LGR	Light grey	1	149.000	6274712
GK-A70170GR	Stone grey	1	149.000	6274716

External corner for changing the direction of the GK device installation trunking. Cover must be ordered separately.

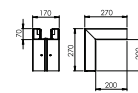

PVC

External corner cover, smooth

Type	Colour	Pack Piece	Weight kg/100 pc.	Item no.
GK-OTGARW	Pure white	2	9.500	6274790
GK-OTGACW	Cream	2	9.500	6274791
GK-OTGALGR	Light grey	2	9.500	6274792
GK-OTGAGR	Stone grey	2	9.500	6274796

PVC external corner cover, smooth surface.

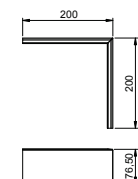

Flat angle cover, for device installation trunking Rapid 80 type GK-70170

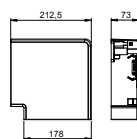

Type	Colour	Length mm	Pack Piece	Weight kg/100 pc.	Item no.
GK-FH70170RW	Pure white	212.5	1	26.150	6274620
GK-FH70170CW	Cream	212.5	1	26.150	6274621
GK-FH70170LGR	Light grey	212.5	1	26.150	6274622

Flat angle cover fitting made of halogen-free PC/ABS for simple creation of a rising or falling 90° change of direction with device installation trunking of the series Rapid 80 GK, GKH, GS and GA. The flat angle cover fitting can be used for symmetrical and asymmetrical trunking types.

Flat angle, for device installation trunking Rapid 80 type GK-70170

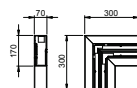

Type	Colour	Pack Piece	Weight kg/100 pc.	Item no.
GK-F70170RW	Pure white	1	91.000	6274720
GK-F70170CW	Cream	1	91.000	6274721
GK-F70170LGR	Light grey	1	91.000	6274722
GK-F70170GR	Stone grey	1	91.000	6274726

Flat angle for changing the direction of the GK device installation trunking.

Flat angle cover, smooth

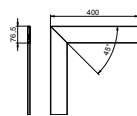

Type	Colour	Pack Piece	Weight kg/100 pc.	Item no.
GK-OTGFRW	Pure white	1	17.000	6274490
GK-OTGFCW	Cream	1	17.000	6274491
GK-OTGFLGR	Light grey	1	17.000	6274492
GK-OTGFGR	Stone grey	1	17.000	6274496

PVC flat angle cover, smooth surface.

Internal corner cover, for device installation trunking Rapid 80 type GK-70170

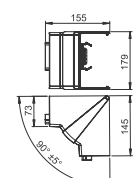

Type	Colour	Pack Piece	Weight kg/100 pc.	Item no.
GK-IH70170RW	Pure white	1	16.300	6274640
GK-IH70170CW	Cream	1	16.300	6274641
GK-IH70170LGR	Light grey	1	16.300	6274642

Internal corner cover made of halogen-free PC/ABS for changing the direction of Rapid 80 device installation trunking of the GK, GKH, GS and GA systems. The fittings can be variably adjusted between 85° and 95° and can be used in symmetrical and asymmetrical trunking.

Internal corner, for device installation trunking Rapid 80 type GK-70170

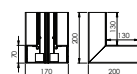

Type	Colour	Pack Piece	Weight kg/100 pc.	Item no.
GK-I70170RW	Pure white	1	130.000	6274740
GK-I70170CW	Cream	1	130.000	6274741
GK-I70170LGR	Light grey	1	130.000	6274742
GK-I70170GR	Stone grey	1	130.000	6274746

Internal corner for changing the direction of the GK device installation trunking.

PVC

T piece, for device installation trunking Rapid 80 type GK-70170

Type	Colour	Pack Piece	Weight kg/100 pc.	Item no.
GK-T70170RW	Pure white	1	120.000	6274760
GK-T70170CW	Cream	1	120.000	6274761
GK-T70170LGR	Light grey	1	120.000	6274762
GK-T70170GR	Stone grey	1	120.000	6274766

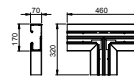

T piece for changing the direction of the GK device installation trunking.

PVC

End piece, for device installation trunking Rapid 80 type GK-70170

Type	Colour	Pack Piece	Weight kg/100 pc.	Item no.
GK-E70170RW	Pure white	1	6.840	6274770
GK-E70170CW	Cream	1	6.840	6274771
GK-E70170LGR	Light grey	1	6.840	6274772
GK-E70170GR	Stone grey	1	6.840	6274776

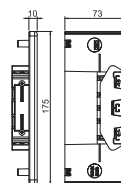

End piece for closing the GK device installation trunking.

PVC

Partition GK-TW70

Type	Length mm	Pack m	Weight kg/100 m	Item no.
GK-TW70	2000	40	17.400	6274900

Partition for mounting in Rapid 80 GK, GA and Rapid IBIS device installation duct or ISS service poles for installing cables of different voltage levels.

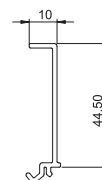

PC / ABS

Duct clamp KL80A

Type	Colour	Pack Piece	Weight kg/100 pc.	Item no.
KL80A	Light grey	20	0.685	6288640

Duct clamp for holding cables securely and for fastening the partition in Rapid 80 GK, GS and GA device installation trunking systems as well as in ISS service poles with a 76.5 mm system opening.



Simply versatile

Rapid 80 device installation trunking

Our Rapid 80 plastic device installation trunking is now available in a halogen-free version. In the event of fire, the self-extinguishing plastic reduces the amount of poisonous smoke gases.

Device installation ducts and trunking



Plastic

**HALOGEN
FREE**

Sheet steel

Easy installation

Wide range of variants

Aluminium

Extensive range of accessories



Device installation trunking Rapid 80, trunking width 130, trunking height 70, halogen-free



GKH device installation trunking made of halogen-free PC/ABS, suitable for direct wall mounting or on wall brackets. Fastening takes place using the perforation in the trunking. The GKH device installation trunking possesses a C profile on the floor to accept a plastic partition. All the switch programmes with a support ring and support clamp design as well as Modul 45 installation devices can be installed in the accessory mounting boxes of series 71GD.... The system opening is 76.5 mm. On each trunking length, a coupling pair is pre-assembled on one side. The cover must be ordered separately.

Type	Colour	Length mm	Pack m	Weight kg/100 m	Item no.
GKH-70130RW	Pure white	2000	8	121.000	6114200

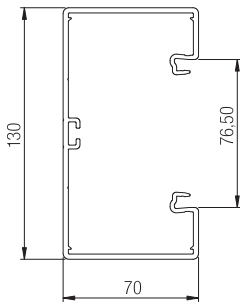

Accessory mounting box 71GD6, single

Type	Colour	Pack Piece	Weight kg/100 pc.	Item no.
71GD6	Iron grey	5	5.600	6288610

Front locking accessory mounting box for switch systems, with folding, and also removable, base for time-saving cable connection, with feed openings for cable diameters of up to 14 mm. Halogen-free version.

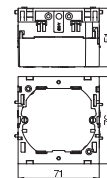

7ZE strain relief

Type	Pack Piece	Weight kg/100 pc.	Item no.
7ZE	50	0.700	6288790

Strain relief with locking clips, suitable for the accessory mounting boxes 7GD... and 71GD...

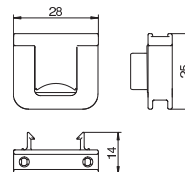

Trunking cover, smooth

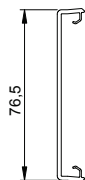
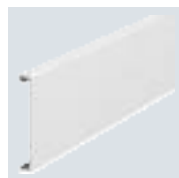

Type	Colour	Length mm	Pack m	Weight kg/100 m	Item no.
GKH-OTGRW	Pure white	2000	16	22.000	6114210

Smooth trunking cover made of halogen-free PC/ABS, for closing device installation trunking with 80 mm system opening.

External corner, for device installation trunking Rapid 80 type GKH-70130

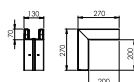

Type	Colour	Pack Piece	Weight kg/100 pc.	Item no.
GKH-A70130RW	Pure white	1	100.000	6114220

External corner made of halogen-free PC/ABS for changing the direction of the GKH device installation trunking. Cover must be ordered separately.

External corner cover, smooth

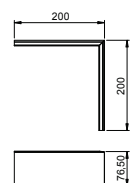

Type	Colour	Pack Piece	Weight kg/100 pc.	Item no.
GKH-OTGARW	Pure white	2	7.500	6114230

PC/ABS external corner cover, smooth surface.

Flat angle cover, for device installation trunking Rapid 80 type GK-70130

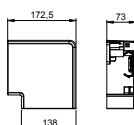

Type	Colour	Length mm	Pack Piece	Weight kg/100 pc.	Item no.
GK-FH70130RW	Pure white	172.5	1	12.461	6274420

Flat angle cover fitting made of halogen-free PC/ABS for simple creation of a rising or falling 90° change of direction with device installation trunking of the series Rapid 80 GK, GKH, GS and GA. The flat angle cover fitting can be used for symmetrical and asymmetrical trunking types.

Flat angle, for device installation trunking Rapid 45-2 type GKH-70130

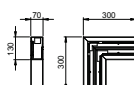

Type	Colour	Pack Piece	Weight kg/100 pc.	Item no.
GKH-F70130RW	Pure white	1	66.000	6114240

Flat angle made of halogen-free PC/ABS for changing the direction of the GKH device installation trunking. Cover must be ordered separately.

PC / ABS



Flat angle cover, smooth

Type	Colour	Pack Piece	Weight kg/100 pc.	Item no.
GKH-OTGFRW	Pure white	1	13.000	6114250

Flat angle cover made of halogen-free PC/ABS.

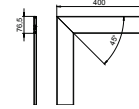

PC / ABS



Internal corner cover, for device installation trunking Rapid 80 type GK-70130

Type	Colour	Pack Piece	Weight kg/100 pc.	Item no.
GK-IH70130RW	Pure white	1	14.900	6274440

Internal corner cover made of halogen-free PC/ABS for changing the direction of Rapid 80 device installation trunking of the GK, GKH, GS and GA systems. The fittings can be variably adjusted between 85° and 95° and can be used in symmetrical and asymmetrical trunking.

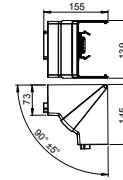

PC / ABS



Internal corner, for device installation trunking Rapid 80 type GKH-70130

Type	Colour	Pack Piece	Weight kg/100 pc.	Item no.
GKH-I70130RW	Pure white	1	90.000	6114260

Internal corner made of halogen-free PC/ABS for changing the direction of the GKH device installation trunking.

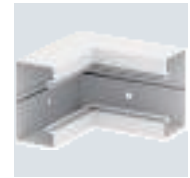
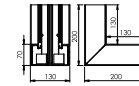

PC / ABS



T piece, for device installation trunking Rapid 80 type GKH-70130

Type	Colour	Pack Piece	Weight kg/100 pc.	Item no.
GKH-T70130RW	Pure white	1	82.000	6114270

T piece made of halogen-free PC/ABS for changing the direction of the GKH device installation trunking.

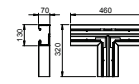

PC / ABS



End piece, for device installation trunking Rapid 80 type GKH-70130

Type	Colour	Pack Piece	Weight kg/100 pc.	Item no.
GKH-E70130RW	Pure white	1	5.203	6114280

End piece made of halogen-free PC/ABS for closing the GKH device installation trunking.

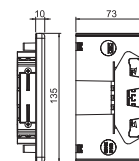

Partition GKH-TW70

PC/
ABS

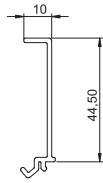

Type	Colour	Length mm	Pack Weight		Item no.
			m	kg/100 m	
GKH-TW70	Pure white	2000	40	14.000	6114290

Partition made of halogen-free PC/ABS for mounting in Rapid 80 GKH (GA) device installation trunking or ISS service poles for installing cables of different voltage levels.

Duct clamp KL80A

PC/
ABS

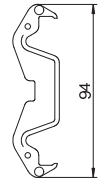

Type	Colour	Pack Weight		Item no.
		Piece	kg/100 pc.	
KL80A	Light grey	20	0.685	6288640

Duct clamp for holding cables securely and for fastening the partition in Rapid 80 GK, GS and GA device installation trunking systems as well as in ISS service poles with a 76.5 mm system opening.





Device installation trunking Rapid 80, trunking width 170, trunking height 70, halogen-free



GKH device installation trunking made of halogen-free PC/ABS, suitable for direct wall mounting or on wall brackets. Fastening takes place using the perforation in the trunking. The GKH device installation trunking possesses a C profile on the floor to accept a plastic partition. All the switch programmes with a support ring and support clamp design as well as Modul 45 installation devices can be installed in the accessory mounting boxes of series 71GD.... The system opening is 76.5 mm. On each trunking length, a coupling pair is pre-assembled on one side. The cover must be ordered separately.

Type	Colour	Length mm	Pack m	Weight kg/100 m	Item no.
GKH-70170RW	Pure white	2000	8	151.000	6114300

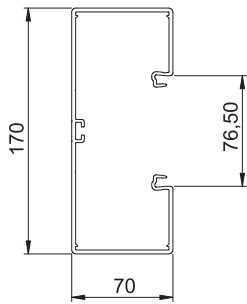

Accessory mounting box 71GD6, single

Type	Colour	Pack Piece	Weight kg/100 pc.	Item no.
71GD6	Iron grey	5	5.600	6288610

Front locking accessory mounting box for switch systems, with folding, and also removable, base for time-saving cable connection, with feed openings for cable diameters of up to 14 mm. Halogen-free version.

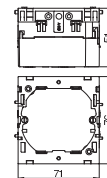

7ZE strain relief

Type	Pack Piece	Weight kg/100 pc.	Item no.
7ZE	50	0.700	6288790

Strain relief with locking clips, suitable for the accessory mounting boxes 7GD... and 71GD... . Cable clamping range to 14 mm.

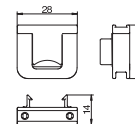

Trunking cover, smooth

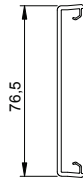

Type	Colour	Length mm	Pack m	Weight kg/100 m	Item no.
GKH-OTGRW	Pure white	2000	16	22.000	6114210

Smooth trunking cover made of halogen-free PC/ABS, for closing device installation trunking with 80 mm system opening.

External corner, for device installation trunking Rapid 80 type GKH-70170

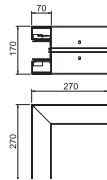

Type	Colour	Pack Piece	Weight kg/100 pc.	Item no.
GKH-A70170RW	Pure white	1	119.000	6114320

External corner made of halogen-free PC/ABS for changing the direction of the GKH device installation trunking. Cover must be ordered separately.

External corner cover, smooth

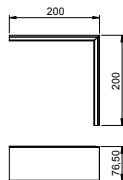

Type	Colour	Pack Piece	Weight kg/100 pc.	Item no.
GKH-OTGARW	Pure white	2	7.500	6114230

PC/ABS external corner cover, smooth surface.

Flat angle cover, for device installation trunking Rapid 80 type GK-70170

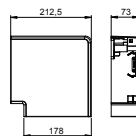

Type	Colour	Length mm	Pack Piece	Weight kg/100 pc.	Item no.
GK-FH70170RW	Pure white	212.5	1	26.150	6274620

Flat angle cover fitting made of halogen-free PC/ABS for simple creation of a rising or falling 90° change of direction with device installation trunking of the series Rapid 80 GK, GKH, GS and GA. The flat angle cover fitting can be used for symmetrical and asymmetrical trunking types.

Flat angle, for device installation trunking Rapid 80 type GKH-70170

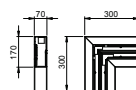

Type	Colour	Pack Piece	Weight kg/100 pc.	Item no.
GKH-F70170RW	Pure white	1	73.000	6114340

Flat angle made of halogen-free PC/ABS for changing the direction of the GKH device installation trunking. Cover must be ordered separately.

PC / ABS



Flat angle cover, smooth

Type	Colour	Pack Piece	Weight kg/100 pc.	Item no.
GKH-OTGFRW	Pure white	1	13.000	6114250

Flat angle cover made of halogen-free PC/ABS.

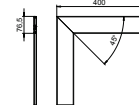

PC / ABS



Internal corner cover, for device installation trunking Rapid 80 type GK-70170

Type	Colour	Pack Piece	Weight kg/100 pc.	Item no.
GK-IH70170RW	Pure white	1	16.300	6274640

Internal corner cover made of halogen-free PC/ABS for changing the direction of Rapid 80 device installation trunking of the GK, GKH, GS and GA systems. The fittings can be variably adjusted between 85° and 95° and can be used in symmetrical and asymmetrical trunking.

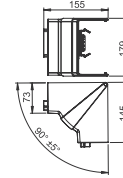

PC / ABS



Internal corner, for device installation trunking Rapid 80 type GKH-70170

Type	Colour	Pack Piece	Weight kg/100 pc.	Item no.
GKH-I70170RW	Pure white	1	100.000	6114360

Internal corner made of halogen-free PC/ABS for changing the direction of the GKH device installation trunking.

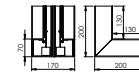

PC / ABS



T piece, for device installation trunking Rapid 80 type GKH-70170

Type	Colour	Pack Piece	Weight kg/100 pc.	Item no.
GKH-T70170RW	Pure white	1	96.000	6114370

T piece made of halogen-free PC/ABS for changing the direction of the GKH device installation trunking.

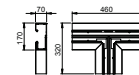

PC / ABS



End piece, for device installation trunking Rapid 80 type GKH-70170

Type	Colour	Pack Piece	Weight kg/100 pc.	Item no.
GKH-E70170RW	Pure white	1	6.144	6114380

End piece made of halogen-free PC/ABS for closing the GKH device installation trunking.

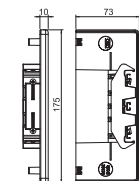

Partition GKH-TW70

PC/
ABS

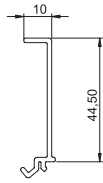

Type	Colour	Length mm	Pack Weight		Item no.
			m	kg/100 m	
GKH-TW70	Pure white	2000	40	14.000	6114290

Partition made of halogen-free PC/ABS for mounting in Rapid 80 GKH (GA) device installation trunking or ISS service poles for installing cables of different voltage levels.

Duct clamp KL80A

PC/
ABS

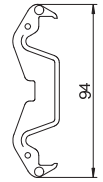

Type	Colour	Pack Weight		Item no.
		Piece	kg/100 pc.	
KL80A	Light grey	20	0.685	6288640

Duct clamp for holding cables securely and for fastening the partition in Rapid 80 GK, GS and GA device installation trunking systems as well as in ISS service poles with a 76.5 mm system opening.





Rapid 80 sheet steel device installation trunking

Installation principle

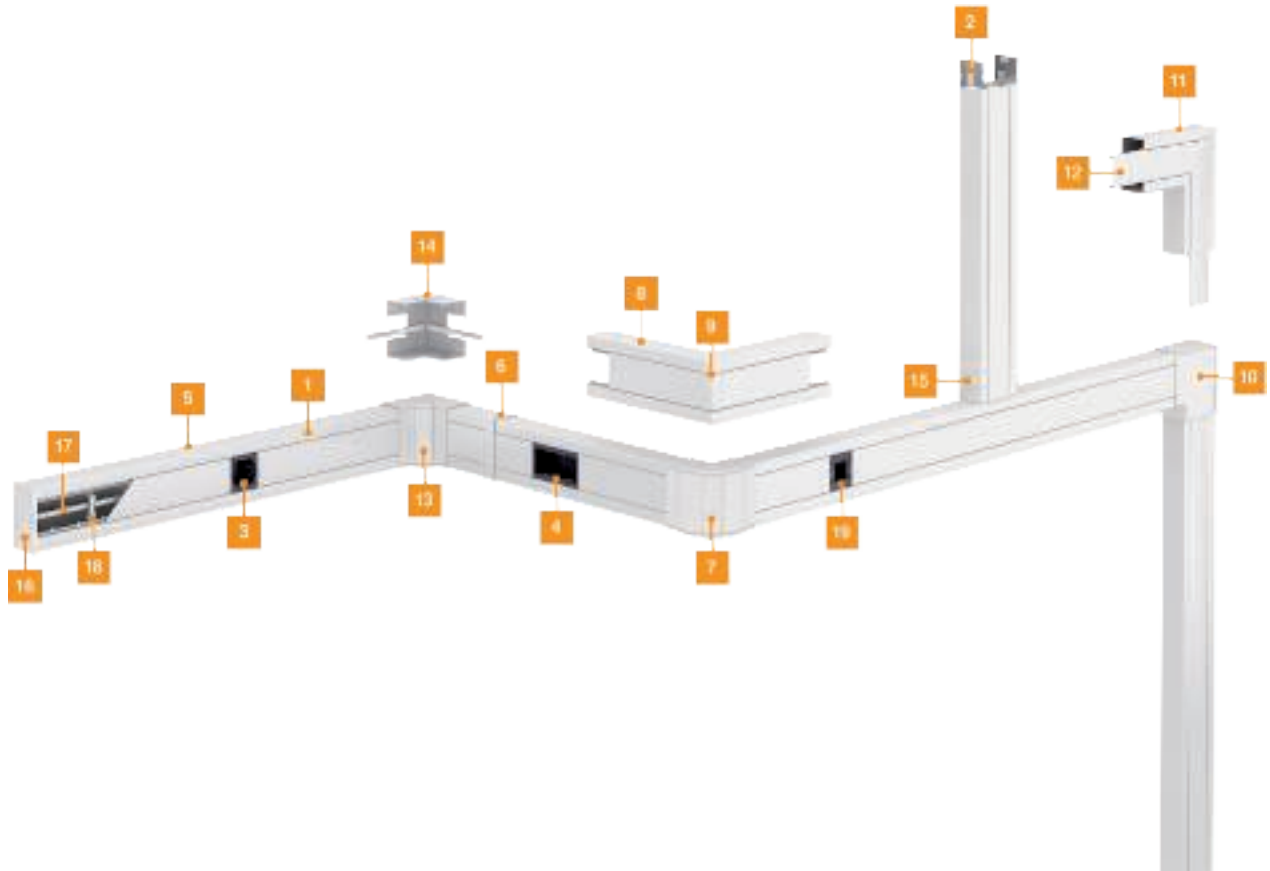

1	Trunking	GS	11	Flat angle	GK-F
2	Coupling	GS-KU	12	Flat angle cover hood	GK-OTGF
3	Accessory mounting box single	71GD	13	Internal corner cover	GS-IH
4	Accessory mounting box double	71GD	14	Internal corner	GK-I
5	Trunking cover	GS-OT	15	T-piece	GS-T
6	Joint cover	GEK_KS	16	Endpiece	GS-E
7	Trunking cover variable	GK-IH	17	Partition	GS-TW
8	External corner	GS-A	18	Trunking clamp	KL80A
9	External corner hood	GS-OTG			
10	Flat angle cover	GK-FH			



St FS

Device installation trunking Rapid 80, trunking width 110, trunking height 70, symmetrical

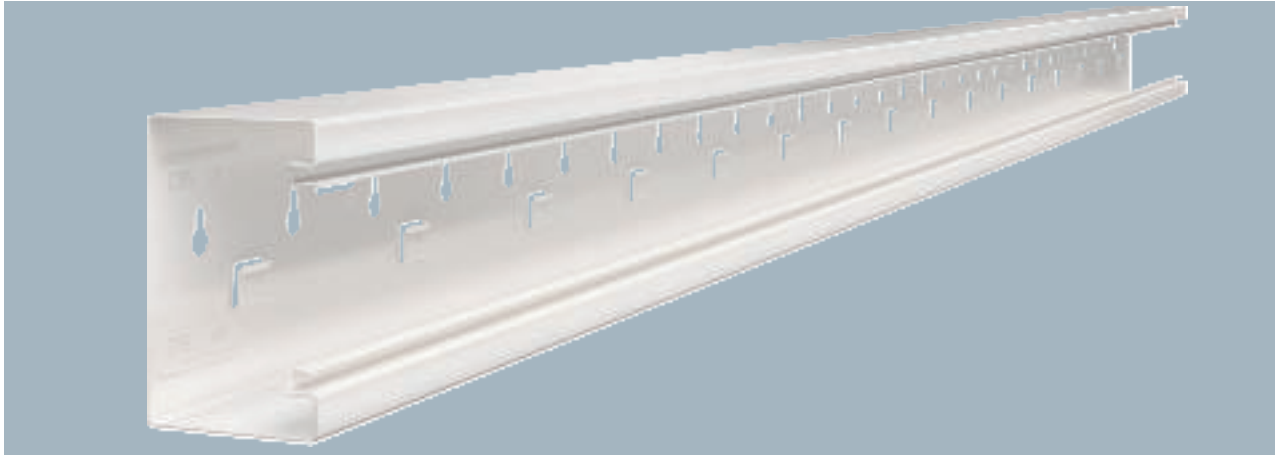

GS device installation trunking for mounting on the wall or on fastening panels. The GS device installation trunking possesses self-contacting locking straps to accept a sheet steel partition. The equipotential bonding between the trunking bases takes place using the trunking coupling. The protective measure and the equipotential bonding is guaranteed between the cover and the base by the self-contacting trunking cover. The real system opening is 76.5 mm. The cover must be ordered separately. Over-lengths up to 3000 mm for trunking bases and covers as well as other RAL colours can be provided on request. The visible surfaces of the painted device installation trunking are laminated.

Type	Colour	Length mm	Pack m	Weight kg/100 m	Item no.
GS-S70110RW	Pure white	2000	12	258.000	6277000
GS-S70110LGR	Light grey	2000	12	258.000	6277002
GS-S70110FS	—	2000	12	258.000	6277003

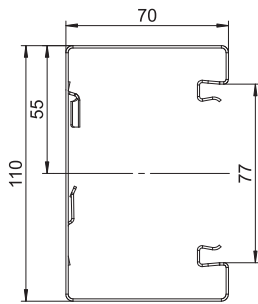

VA

Coupling GS-KUP70

Type	Length mm	Pack PU	Weight kg/100 PUs	Item no.
GS-KUP70	120	1	6.400	6277290

Coupling for connecting the trunking bases. This creates the equipotential bonding between the trunking bases. The scope of delivery of a coupling includes 2 connection plates.

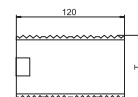

PA

Accessory mounting box 71GD6, single

Type	Colour	Pack Piece	Weight kg/100 pc.	Item no.
71GD6	Iron grey	5	5.600	6288610

Front locking accessory mounting box for switch systems, with folding, and also removable, base for time-saving cable connection, with feed openings for cable diameters of up to 14 mm. Halogen-free version.

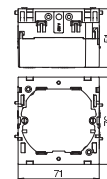

7ZE strain relief

PA

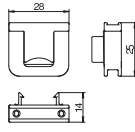

Type	Pack Piece	Weight kg/100 pc.	Item no.
7ZE	50	0.700	6288790

Strain relief with locking clips, suitable for the accessory mounting boxes 7GD... and 71GD...
Cable clamping range to 14 mm.

Trunking cover, sheet steel

St

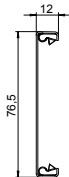

Type	Colour	Length mm	Pack m	Weight kg/100 m	Item no.
GS-OTRW	Pure white	2000	2	65.000	6279850
GS-OTLGR	Light grey	2000	2	65.000	6279852

Cover to close the device installation trunking GEK-S and GEK-A.

Locking bracket RKV3V

St



Type	Pack Piece	Weight kg/100 pc.	Item no.
RKV3V	20	0.085	6288700

Locking bracket for the mechanical and electrical connection of duct covers and duct bases. Suitable for covers of Rapid 45, Rapid 80 and ISS systems.

Plastic trunking cover, smooth

PVC

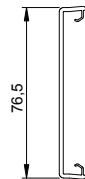

Type	Colour	Length mm	Pack m	Weight kg/100 m	Item no.
GK-OTGRW	Pure white	2000	16	27.500	6278680

Smooth trunking cover, for closing device installation trunking with 76.5 mm system opening.

External corner cover, smooth

PVC

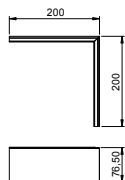

Type	Colour	Pack Piece	Weight kg/100 pc.	Item no.
GK-OTGARW	Pure white	2	9.500	6274790

PVC external corner cover, smooth surface.

PC / ABS



Flat angle cover, for device installation trunking Rapid 80 type GK-70110

Type	Colour	Length mm	Pack Piece	Weight kg/100 pc.	Item no.
GK-FH70110RW	Pure white	152.5	1	15.100	6274220

Flat angle cover fitting made of halogen-free PC/ABS for simple creation of a rising or falling 90° change of direction with device installation trunking of the series Rapid 80 GK, GKH, GS and GA. The flat angle cover fitting can be used for symmetrical and asymmetrical trunking types.

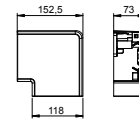

PVC

Flat angle cover, smooth

Type	Colour	Pack Piece	Weight kg/100 pc.	Item no.
GK-OTGFRW	Pure white	1	17.000	6274490

PVC flat angle cover, smooth surface.

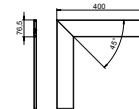

PC / ABS



Internal corner hood, for Rapid 80 device installation trunking, type GK-70110

Type	Colour	Pack Piece	Weight kg/100 pc.	Item no.
GK-IH70110RW	Pure white	1	14.200	6274240

Internal corner cover made of halogen-free PC/ABS for changing the direction of Rapid 80 device installation trunking of the GK, GKH, GS and GA systems. The fittings can be variably adjusted between 85° and 95° and can be used in symmetrical and asymmetrical trunking.

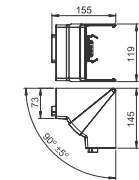

St

Internal corner, for device installation trunking Rapid 80 type GS-S70110

Type	Colour	Pack Piece	Weight kg/100 pc.	Item no.
GS-SI70110RW	Pure white	1	55.000	6277040

Internal corner for direct installation on GS device installation trunking.

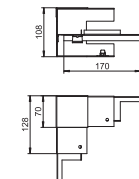

St

Partition GS-TW70

Type	Length mm	Suitable for duct depth	Pack m	Weight kg/100 m	Item no.
GS-TW70	2000	70	2	58.650	6277090

Partition to divide the trunking for different voltage levels. Self-conducting contacting during mounting.

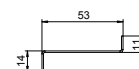

Partition GS-TW90

St

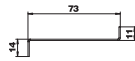

Type	Length		Pack	Weight	Item no.
	mm	Suitable for duct depth			
GS-TW90	2000	90	2	74.400	6277095

Partition to divide the trunking for different voltage levels. Self-conducting contacting during mounting.

Duct clamp KL80A

PC/ABS

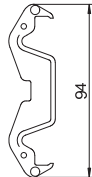

Type	Colour	Pack	Weight	Item no.
KL80A	Light grey	20	0.685	6288640

Duct clamp for holding cables securely and for fastening the partition in Rapid 80 GK, GS and GA device installation trunking systems as well as in ISS service poles with a 76.5 mm system opening.

Protective conductor connection bracket

St G

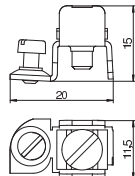

Type	Surface	Pack	Weight	Item no.
8AWR	Electrogalvanised	10	0.610	6288704

Protective conductor connection bracket to include steel and aluminium device installation trunking, service poles and system components of underfloor duct systems in the protective measure.
Clamping area: 2 x 1.5–4 mm²

St

Device installation trunking Rapid 80, trunking width 130, trunking height 70, symmetrical

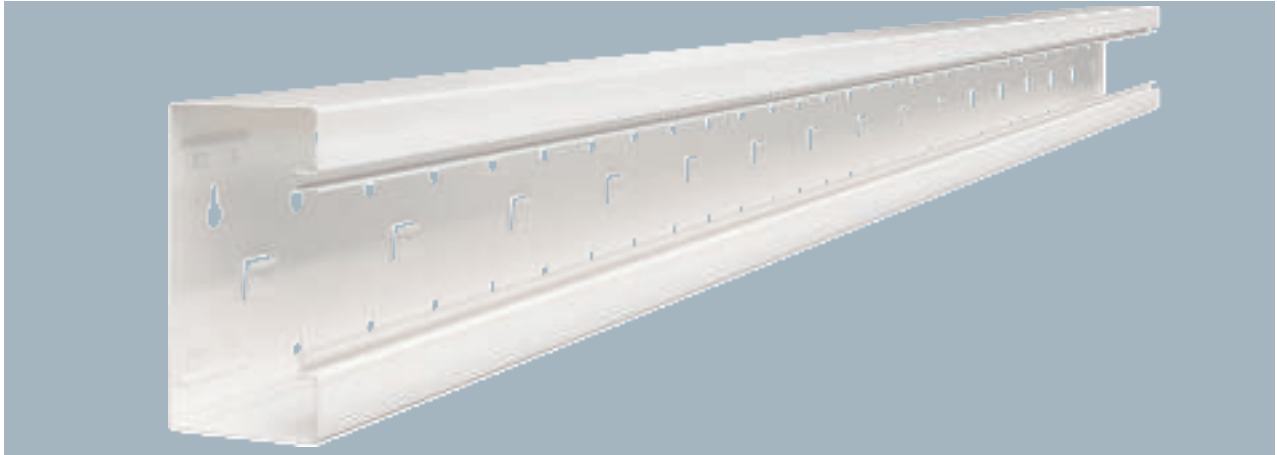

GS device installation trunking for mounting on the wall or on fastening panels. The GS device installation trunking possesses self-contacting locking straps to accept a sheet steel partition. The equipotential bonding between the trunking bases takes place using the trunking coupling. The protective measure and the equipotential bonding is guaranteed between the cover and the base by the self-contacting trunking cover. The real system opening is 76.5 mm. The cover must be ordered separately. Overlengths up to 3,000 mm for trunking bases and covers as well as other RAL colours can be provided on request. The visible surfaces of the painted device installation trunking are laminated.

Type	Colour	Length mm	Pack m	Weight kg/100 m	Item no.
GS-S70130RW	Pure white	2000	12	289.000	6277200
GS-S70130LGR	Light grey	2000	12	289.000	6277202

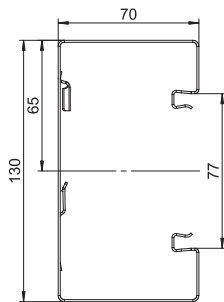

Device installation trunking Rapid 80, trunking width 130, trunking height 90, symmetrical

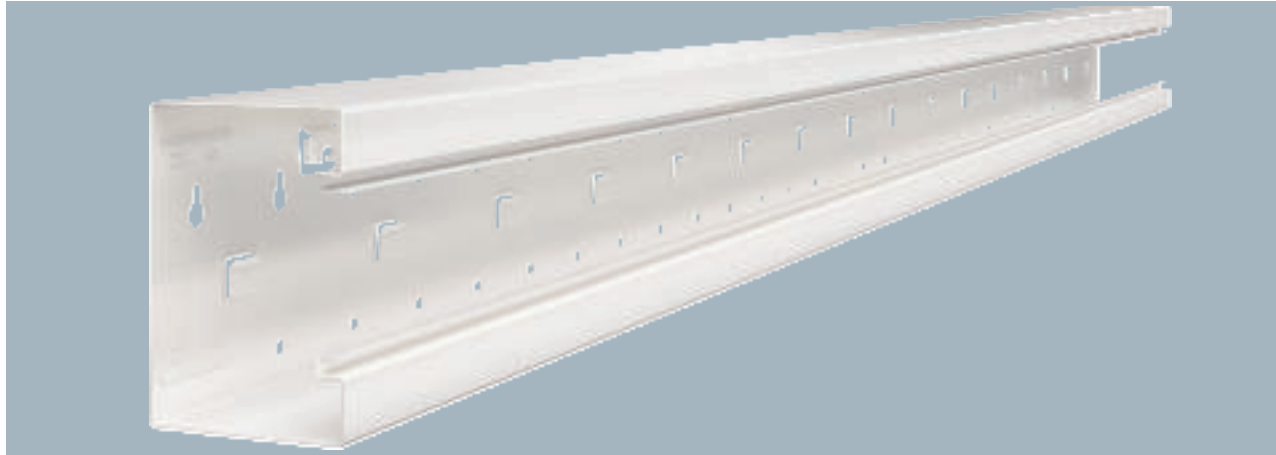

Type	Colour	Length mm	Pack m	Weight kg/100 m	Item no.
GS-S90130RW	Pure white	2000	8	321.000	6277300

GS device installation trunking for mounting on the wall or on fastening panels. The GS device installation trunking possesses self-contacting locking straps to accept a sheet steel partition. The equipotential bonding between the trunking bases takes place using the trunking coupling. The protective measure and the equipotential bonding is guaranteed between the cover and the base by the self-contacting trunking cover. The real system opening is 76.5 mm. The cover must be ordered separately. Overlengths up to 3,000 mm for trunking bases and covers as well as other RAL colours can be provided on request. The visible surfaces of the painted device installation trunking are laminated.

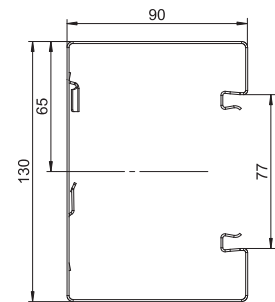

Coupling GS-KUP70

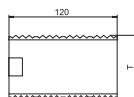

Type	Length mm	Pack PU	Weight kg/100 PUs	Item no.
GS-KUP70	120	1	6.400	6277290

Coupling for connecting the trunking bases. This creates the equipotential bonding between the trunking bases. The scope of delivery of a coupling includes 2 connection plates.

Accessory mounting box 71GD6, single

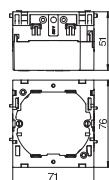

Type	Colour	Pack Piece	Weight kg/100 pc.	Item no.
71GD6	Iron grey	5	5.600	6288610

Front locking accessory mounting box for switch systems, with folding, and also removable, base for time-saving cable connection, with feed openings for cable diameters of up to 14 mm. Halogen-free version.

PA

7ZE strain relief

Type	Pack Piece	Weight kg/100 pc.	Item no.
7ZE	50	0.700	6288790

Strain relief with locking clips, suitable for the accessory mounting boxes 7GD... and 71GD...
Cable clamping range to 14 mm.

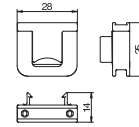

St

Trunking cover, sheet steel

Type	Colour	Length mm	Pack m	Weight kg/100 m	Item no.
GS-OTRW	Pure white	2000	2	65.000	6279850

Cover to close the device installation trunking GEK-S and GEK-A.

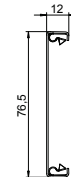

St

Locking bracket RKV3V

Type	Pack Piece	Weight kg/100 pc.	Item no.
RKV3V	20	0.085	6288700

Locking bracket for the mechanical and electrical connection of duct covers and duct bases. Suitable for covers of Rapid 45, Rapid 80 and ISS systems.



PVC

Plastic trunking cover, smooth

Type	Colour	Length mm	Pack m	Weight kg/100 m	Item no.
GK-OTGRW	Pure white	2000	16	27.500	6278680

Smooth trunking cover, for closing device installation trunking with 76.5 mm system opening.

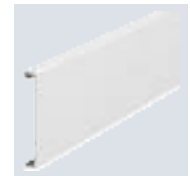

PVC

External corner cover, smooth

Type	Colour	Pack Piece	Weight kg/100 pc.	Item no.
GK-OTGARW	Pure white	2	9.500	6274790

PVC external corner cover, smooth surface.

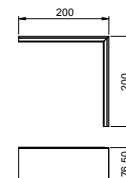

Flat angle cover, for device installation trunking Rapid 80 type GK-70130

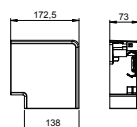

Type	Colour	Length mm	Pack Piece	Weight kg/100 pc.	Item no.
GK-FH70130RW	Pure white	172.5	1	12.461	6274420

Flat angle cover fitting made of halogen-free PC/ABS for simple creation of a rising or falling 90° change of direction with device installation trunking of the series Rapid 80 GK, GKH, GS and GA. The flat angle cover fitting can be used for symmetrical and asymmetrical trunking types.

Flat angle cover, smooth

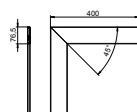

Type	Colour	Pack Piece	Weight kg/100 pc.	Item no.
GK-OTGFRW	Pure white	1	17.000	6274490

PVC flat angle cover, smooth surface.

Internal corner cover, for device installation trunking Rapid 80 type GK-70130

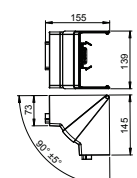

Type	Colour	Pack Piece	Weight kg/100 pc.	Item no.
GK-IH70130RW	Pure white	1	14.900	6274440

Internal corner cover made of halogen-free PC/ABS for changing the direction of Rapid 80 device installation trunking of the GK, GKH, GS and GA systems. The fittings can be variably adjusted between 85° and 95° and can be used in symmetrical and asymmetrical trunking.

End piece, for device installation trunking Rapid 80 type GS-S70130

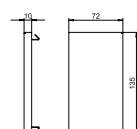

Type	Colour	Pack Piece	Weight kg/100 pc.	Item no.
GS-E70130RW	Pure white	1	10.800	6277270

End piece for GS device installation trunking.

End piece, for device installation trunking Rapid 80 type GS-S90130

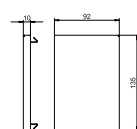

Type	Colour	Pack Piece	Weight kg/100 pc.	Item no.
GS-E90130RW	Pure white	1	13.800	6277370

End piece for GS device installation trunking.

St

Partition GS-TW70

Type	Length mm	Suitable for duct depth	Pack m	Weight kg/100 m	Item no.
GS-TW70	2000	70	2	58.650	6277090

Partition to divide the trunking for different voltage levels. Self-conducting contacting during mounting.

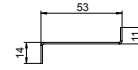

St

Partition GS-TW90

Type	Length mm	Suitable for duct depth	Pack m	Weight kg/100 m	Item no.
GS-TW90	2000	90	2	74.400	6277095

Partition to divide the trunking for different voltage levels. Self-conducting contacting during mounting.

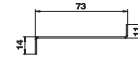

PC /
ABS

Duct clamp KL80A

Type	Colour	Pack Piece	Weight kg/100 pc.	Item no.
KL80A	Light grey	20	0.685	6288640

Duct clamp for holding cables securely and for fastening the partition in Rapid 80 GK, GS and GA device installation trunking systems as well as in ISS service poles with a 76.5 mm system opening.



St G

Protective conductor connection bracket

Type	Surface	Pack Piece	Weight kg/100 pc.	Item no.
8AWR	Electrogalvanised	10	0.610	6288704

Protective conductor connection bracket to include steel and aluminium device installation trunking, service poles and system components of underfloor duct systems in the protective measure.
Clamping area: 2 x 1.5–4 mm²

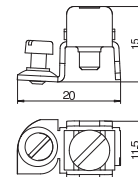

Trunking height 70 and 90 mm, trunking width 130 mm, asymmetrical

St

Device installation trunking Rapid 80, trunking width 130, trunking height 70, asymmetrical

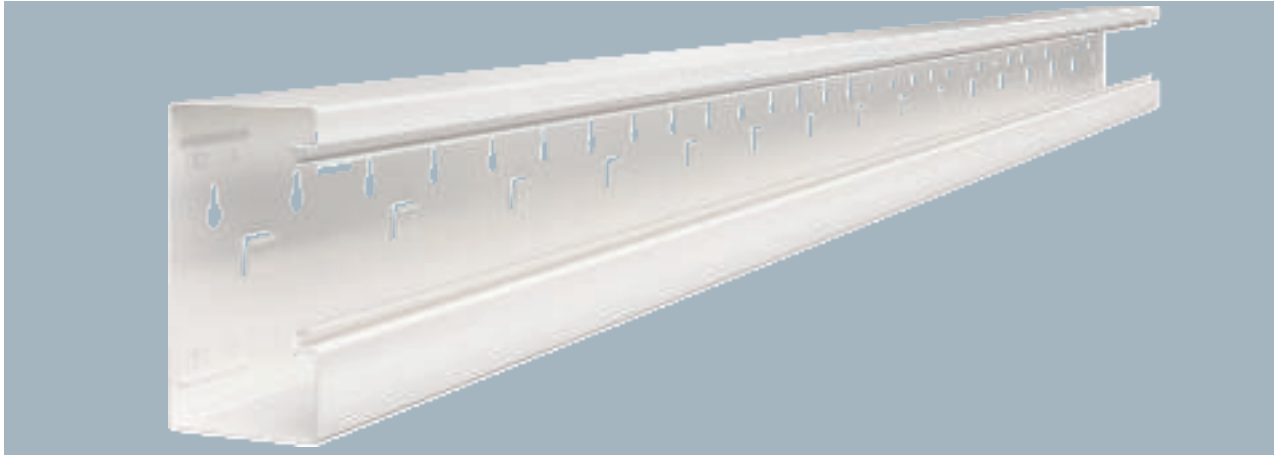

Type	Colour	Length mm	Pack m	Weight kg/100 m	Item no.
GS-A70130RW	Pure white	2000	12	289.000	6277400

GS device installation trunking for mounting on the wall or on fastening panels. The GS device installation trunking possesses self-contacting locking straps to accept a sheet steel partition. The equipotential bonding between the trunking bases takes place using the trunking coupling. The protective measure and the equipotential bonding is guaranteed between the cover and the base by the self-contacting trunking cover. The real system opening is 76.5 mm. The cover must be ordered separately. Overlengths up to 3,000 mm for trunking bases and covers as well as other RAL colours can be provided on request. The visible surfaces of the painted device installation trunking are laminated.

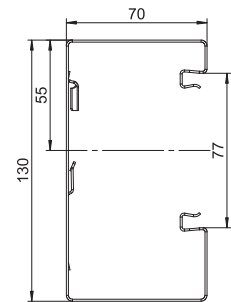

St

Device installation trunking Rapid 80, trunking width 130, trunking height 90, asymmetrical



GS device installation trunking for mounting on the wall or on fastening panels. The GS device installation trunking possesses self-contacting locking straps to accept a sheet steel partition. The equipotential bonding between the trunking bases takes place using the trunking coupling. The protective measure and the equipotential bonding is guaranteed between the cover and the base by the self-contacting trunking cover. The real system opening is 76.5 mm. The cover must be ordered separately. Overlengths up to 3,000 mm for trunking bases and covers as well as other RAL colours can be provided on request. The visible surfaces of the painted device installation trunking are laminated.

Type	Colour	Length mm	Pack m	Weight		Item no.
				m	kg/100 m	
GS-A90130RW	Pure white	2000	8	321.000		6277500

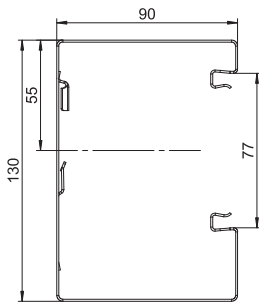

VA

Coupling GS-KUP70

Type	Length mm	Pack PU	Weight		Item no.
			kg/100 PUs	PUs	
GS-KUP70	120	1	6.400		6277290

Coupling for connecting the trunking bases. This creates the equipotential bonding between the trunking bases. The scope of delivery of a coupling includes 2 connection plates.

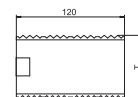

VA

Coupling GS-KUP90

Type	Length mm	Pack PU	Weight		Item no.
			kg/100 PUs	PUs	
GS-KUP90	120	1	8.200		6277294

Coupling for connecting the trunking bases. This creates the equipotential bonding between the trunking bases. The scope of delivery of a coupling includes 2 connection plates.

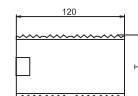

Accessory mounting box 71GD6, single

PA

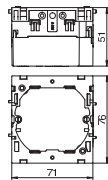

Type	Colour	Pack Piece	Weight kg/100 pc.	Item no.
71GD6	Iron grey	5	5.600	6288610

Front locking accessory mounting box for switch systems, with folding, and also removable, base for time-saving cable connection, with feed openings for cable diameters of up to 14 mm. Halogen-free version.

7ZE strain relief

PA

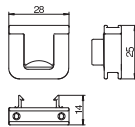

Type	Pack Piece	Weight kg/100 pc.	Item no.
7ZE	50	0.700	6288790

Strain relief with locking clips, suitable for the accessory mounting boxes 7GD... and 71GD... . Cable clamping range to 14 mm.

Trunking cover, sheet steel

St

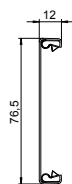

Type	Colour	Length mm	Pack m	Weight kg/100 m	Item no.
GS-OTRW	Pure white	2000	2	65.000	6279850

Cover to close the device installation trunking GEK-S and GEK-A.

Locking bracket RKV3V

St



Type	Pack Piece	Weight kg/100 pc.	Item no.
RKV3V	20	0.085	6288700

Locking bracket for the mechanical and electrical connection of duct covers and duct bases. Suitable for covers of Rapid 45, Rapid 80 and ISS systems.

Plastic trunking cover, smooth

PVC

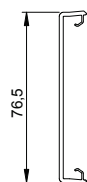

Type	Colour	Length mm	Pack m	Weight kg/100 m	Item no.
GK-OTGRW	Pure white	2000	16	27.500	6278680

Smooth trunking cover, for closing device installation trunking with 76.5 mm system opening.

PVC

External corner cover, smooth

Type	Colour	Pack Piece	Weight kg/100 pc.	Item no.
GK-OTGARW	Pure white	2	9.500	6274790

PVC external corner cover, smooth surface.

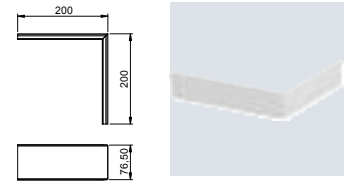

PC / ABS



Flat angle cover, for device installation trunking Rapid 80 type GK-70130

Type	Colour	Length mm	Pack Piece	Weight kg/100 pc.	Item no.
GK-FH70130RW	Pure white	172.5	1	12.461	6274420

Flat angle cover fitting made of halogen-free PC/ABS for simple creation of a rising or falling 90° change of direction with device installation trunking of the series Rapid 80 GK, GKH, GS and GA. The flat angle cover fitting can be used for symmetrical and asymmetrical trunking types.

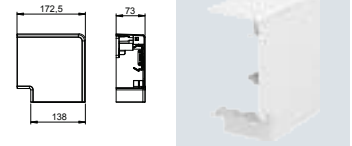

PVC

Flat angle cover, smooth

Type	Colour	Pack Piece	Weight kg/100 pc.	Item no.
GK-OTGFRW	Pure white	1	17.000	6274490

PVC flat angle cover, smooth surface.

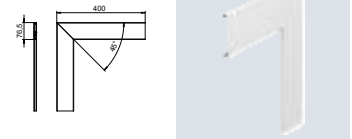

PC / ABS



Internal corner cover, for device installation trunking Rapid 80 type GK-70130

Type	Colour	Pack Piece	Weight kg/100 pc.	Item no.
GK-IH70130RW	Pure white	1	14.900	6274440

Internal corner cover made of halogen-free PC/ABS for changing the direction of Rapid 80 device installation trunking of the GK, GKH, GS and GA systems. The fittings can be variably adjusted between 85° and 95° and can be used in symmetrical and asymmetrical trunking.

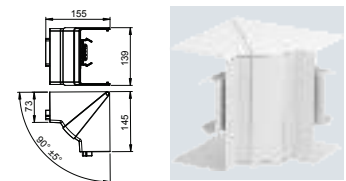

St

End piece, for device installation trunking Rapid 80 type GS-S70130

Type	Colour	Pack Piece	Weight kg/100 pc.	Item no.
GS-E70130RW	Pure white	1	10.800	6277270

End piece for GS device installation trunking.

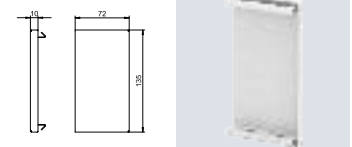

End piece, for device installation trunking Rapid 80 type GS-S90130

St

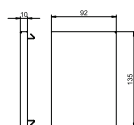

Type	Colour		Pack	Weight	Item no.
	mm	Suitable for duct depth	Piece	kg/100 pc.	
GS-E90130RW	Pure white		1	13.800	6277370

End piece for GS device installation trunking.

Partition GS-TW70

St

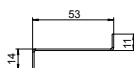

Type	Length		Pack	Weight	Item no.
	mm	Suitable for duct depth	m	kg/100 m	
GS-TW70	2000	70	2	58.650	6277090

Partition to divide the trunking for different voltage levels. Self-conducting contacting during mounting.

Partition GS-TW90

St

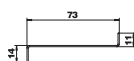

Type	Length		Pack	Weight	Item no.
	mm	Suitable for duct depth	m	kg/100 m	
GS-TW90	2000	90	2	74.400	6277095

Partition to divide the trunking for different voltage levels. Self-conducting contacting during mounting.

Duct clamp KL80A

PC/ABS

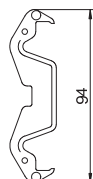

Type	Colour		Pack	Weight	Item no.
	mm	Suitable for duct depth	Piece	kg/100 pc.	
KL80A	Light grey		20	0.685	6288640

Duct clamp for holding cables securely and for fastening the partition in Rapid 80 GK, GS and GA device installation trunking systems as well as in ISS service poles with a 76.5 mm system opening.

Protective conductor connection bracket

St G

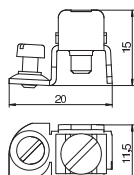

Type	Surface		Pack	Weight	Item no.
	mm	Suitable for duct depth	Piece	kg/100 pc.	
8AWR	Electrogalvanised		10	0.610	6288704

Protective conductor connection bracket to include steel and aluminium device installation trunking, service poles and system components of underfloor duct systems in the protective measure.
Clamping area: 2 x 1.5–4 mm²

St

Device installation trunking Rapid 80, trunking width 170, trunking height 70, symmetrical

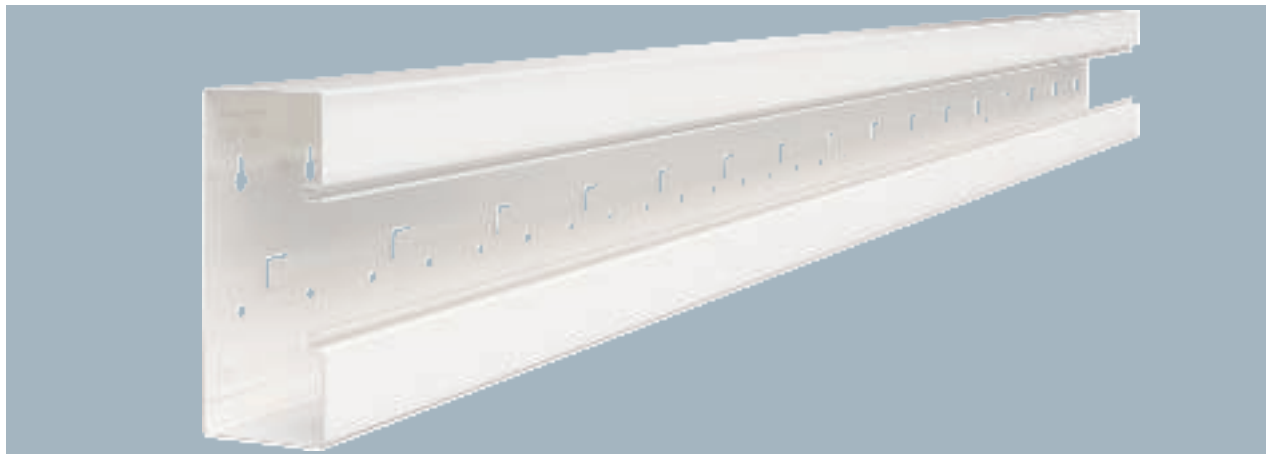

GS device installation trunking for mounting on the wall or on fastening panels. The GS device installation trunking possesses self-contacting locking straps to accept a sheet steel partition. The equipotential bonding between the trunking bases takes place using the trunking coupling. The protective measure and the equipotential bonding is guaranteed between the cover and the base by the self-contacting trunking cover. The real system opening is 76.5 mm. The cover must be ordered separately. Overlengths up to 3,000 mm for trunking bases and covers as well as other RAL colours can be provided on request. The visible surfaces of the painted device installation trunking are laminated.

Type	Colour	Length mm	Pack m	Weight		Item no.
				kg/100 m		
GS-S70170RW	Pure white	2000	8	352.000		6277600

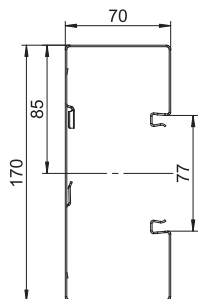

VA

Coupling GS-KUP70

Type	Length mm	Pack PU	Weight		Item no.
			kg/100 PUs		
GS-KUP70	120	1	6.400		6277290

Coupling for connecting the trunking bases. This creates the equipotential bonding between the trunking bases. The scope of delivery of a coupling includes 2 connection plates.

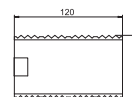

PA

Accessory mounting box 71GD6, single

Type	Colour	Pack Piece	Weight		Item no.
			kg/100 pc.		
71GD6	Iron grey	5	5.600		6288610

Front locking accessory mounting box for switch systems, with folding, and also removable, base for time-saving cable connection, with feed openings for cable diameters of up to 14 mm. Halogen-free version.

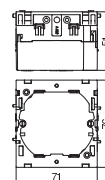

7ZE strain relief

PA

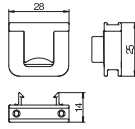

Type	Pack Piece	Weight kg/100 pc.	Item no.
7ZE	50	0.700	6288790

Strain relief with locking clips, suitable for the accessory mounting boxes 7GD... and 71GD...
Cable clamping range to 14 mm.

Trunking cover, sheet steel

St

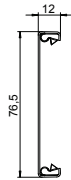
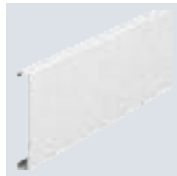

Type	Colour	Length mm	Pack m	Weight kg/100 m	Item no.
GS-OTRW	Pure white	2000	2	65.000	6279850

Cover to close the device installation trunking GEK-S and GEK-A.

Locking bracket RKV3V

St



Type	Pack Piece	Weight kg/100 pc.	Item no.
RKV3V	20	0.085	6288700

Locking bracket for the mechanical and electrical connection of duct covers and duct bases. Suitable for covers of Rapid 45, Rapid 80 and ISS systems.

Plastic trunking cover, smooth

PVC

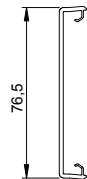

Type	Colour	Length mm	Pack m	Weight kg/100 m	Item no.
GK-OTGRW	Pure white	2000	16	27.500	6278680

Smooth trunking cover, for closing device installation trunking with 76.5 mm system opening.

External corner cover, smooth

PVC

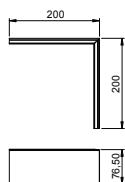

Type	Colour	Pack Piece	Weight kg/100 pc.	Item no.
GK-OTGARW	Pure white	2	9.500	6274790

PVC external corner cover, smooth surface.

PC / ABS



Flat angle cover, for device installation trunking Rapid 80 type GK-70170

Type	Colour	Length mm	Pack Piece	Weight kg/100 pc.	Item no.
GK-FH70170RW	Pure white	212.5	1	26.150	6274620

Flat angle cover fitting made of halogen-free PC/ABS for simple creation of a rising or falling 90° change of direction with device installation trunking of the series Rapid 80 GK, GKH, GS and GA. The flat angle cover fitting can be used for symmetrical and asymmetrical trunking types.

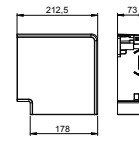

PVC

Flat angle cover, smooth

Type	Colour	Pack Piece	Weight kg/100 pc.	Item no.
GK-OTGFRW	Pure white	1	17.000	6274490

PVC flat angle cover, smooth surface.

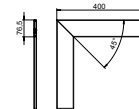

PC / ABS



Internal corner cover, for device installation trunking Rapid 80 type GK-70170

Type	Colour	Pack Piece	Weight kg/100 pc.	Item no.
GK-IH70170RW	Pure white	1	16.300	6274640

Internal corner cover made of halogen-free PC/ABS for changing the direction of Rapid 80 device installation trunking of the GK, GKH, GS and GA systems. The fittings can be variably adjusted between 85° and 95° and can be used in symmetrical and asymmetrical trunking.

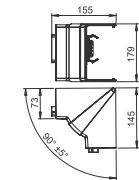

St

End piece, for device installation trunking Rapid 80 type GS-S70170

Type	Colour	Pack Piece	Weight kg/100 pc.	Item no.
GS-E70170RW	Pure white	1	12.900	6277670

End piece for GS device installation trunking.

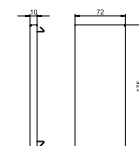

St

Partition GS-TW70

Type	Length mm	Suitable for duct depth	Pack m	Weight kg/100 m	Item no.
GS-TW70	2000	70	2	58.650	6277090

Partition to divide the trunking for different voltage levels. Self-conducting contacting during mounting.

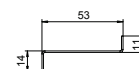

Trunking height 70 mm, trunking width 170 mm

Partition GS-TW90

St

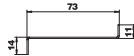

Type	Length		Pack	Weight		Item no.
	mm	Suitable for duct depth		m	kg/100 m	
GS-TW90	2000	90	2	74.400	6277095	

Partition to divide the trunking for different voltage levels. Self-conducting contacting during mounting.

Duct clamp KL80A

PC/ABS

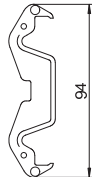

Type	Colour	Pack	Weight		Item no.
			Piece	kg/100 pc.	
KL80A	Light grey	20	0.685	6288640	

Duct clamp for holding cables securely and for fastening the partition in Rapid 80 GK, GS and GA device installation trunking systems as well as in ISS service poles with a 76.5 mm system opening.

Protective conductor connection bracket

St G

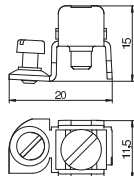

Type	Surface	Pack	Weight		Item no.
			Piece	kg/100 pc.	
8AWR	Electrogalvanised	10	0.610	6288704	

Protective conductor connection bracket to include steel and aluminium device installation trunking, service poles and system components of underfloor duct systems in the protective measure. Clamping area: 2 x 1.5–4 mm²

Trunking height 70 mm, trunking width 170 mm, asymmetrical

Coupling GS-KUP70

VA

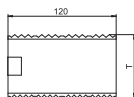

Type	Length		Pack	Weight		Item no.
	mm			PU	kg/100 PUs	
GS-KUP70	120		1	6.400	6277290	

Coupling for connecting the trunking bases. This creates the equipotential bonding between the trunking bases. The scope of delivery of a coupling includes 2 connection plates.

Accessory mounting box 71GD6, single

PA

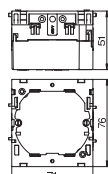

Type	Colour	Pack	Weight		Item no.
			Piece	kg/100 pc.	
71GD6	Iron grey	5	5.600	6288610	

Front locking accessory mounting box for switch systems, with folding, and also removable, base for time-saving cable connection, with feed openings for cable diameters of up to 14 mm. Halogen-free version.

PA

7ZE strain relief

Type	Pack Piece	Weight kg/100 pc.	Item no.
7ZE	50	0.700	6288790

Strain relief with locking clips, suitable for the accessory mounting boxes 7GD... and 71GD...
Cable clamping range to 14 mm.

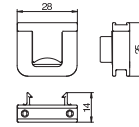

St

Trunking cover, sheet steel

Type	Colour	Length mm	Pack m	Weight kg/100 m	Item no.
GS-OTRW	Pure white	2000	2	65.000	6279850

Cover to close the device installation trunking GEK-S and GEK-A.

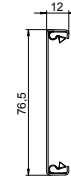

St

Locking bracket RKV3V

Type	Pack Piece	Weight kg/100 pc.	Item no.
RKV3V	20	0.085	6288700

Locking bracket for the mechanical and electrical connection of duct covers and duct bases. Suitable for covers of Rapid 45, Rapid 80 and ISS systems.



PVC

Plastic trunking cover, smooth

Type	Colour	Length mm	Pack m	Weight kg/100 m	Item no.
GK-OTGRW	Pure white	2000	16	27.500	6278680

Smooth trunking cover, for closing device installation trunking with 76.5 mm system opening.

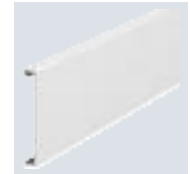
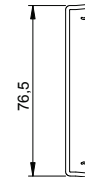

PVC

External corner cover, smooth

Type	Colour	Pack Piece	Weight kg/100 pc.	Item no.
GK-OTGARW	Pure white	2	9.500	6274790

PVC external corner cover, smooth surface.

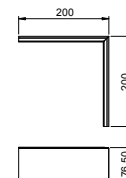

Flat angle cover, for device installation trunking Rapid 80 type GK-70170

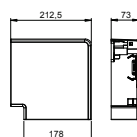

Type	Colour	Length mm	Pack Piece	Weight kg/100 pc.	Item no.
GK-FH70170RW	Pure white	212.5	1	26.150	6274620

Flat angle cover fitting made of halogen-free PC/ABS for simple creation of a rising or falling 90° change of direction with device installation trunking of the series Rapid 80 GK, GKH, GS and GA. The flat angle cover fitting can be used for symmetrical and asymmetrical trunking types.

Flat angle cover, smooth

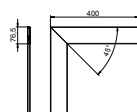

Type	Colour	Pack Piece	Weight kg/100 pc.	Item no.
GK-OTGFRW	Pure white	1	17.000	6274490

PVC flat angle cover, smooth surface.

Internal corner cover, for device installation trunking Rapid 80 type GK-70170

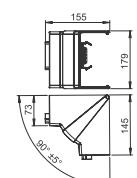

Type	Colour	Pack Piece	Weight kg/100 pc.	Item no.
GK-IH70170RW	Pure white	1	16.300	6274640

Internal corner cover made of halogen-free PC/ABS for changing the direction of Rapid 80 device installation trunking of the GK, GKH, GS and GA systems. The fittings can be variably adjusted between 85° and 95° and can be used in symmetrical and asymmetrical trunking.

End piece, for device installation trunking Rapid 80 type GS-S70170

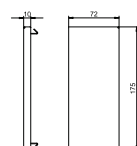

Type	Colour	Pack Piece	Weight kg/100 pc.	Item no.
GS-E70170RW	Pure white	1	12.900	6277670

End piece for GS device installation trunking.

Partition GS-TW70

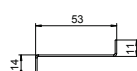

Type	Length mm	Suitable for duct depth	Pack m	Weight kg/100 m	Item no.
GS-TW70	2000	70	2	58.650	6277090

Partition to divide the trunking for different voltage levels. Self-conducting contacting during mounting.

St

Partition GS-TW90

Type	Length		Suitable for duct depth	Pack m	Weight kg/100 m	Item no.
	mm					
GS-TW90	2000	90		2	74.400	6277095

Partition to divide the trunking for different voltage levels. Self-conducting contacting during mounting.

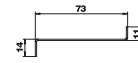

PC / ABS

Duct clamp KL80A

Type	Colour		Pack Piece	Weight kg/100 pc.	Item no.
KL80A	Light grey		20	0.685	6288640

Duct clamp for holding cables securely and for fastening the partition in Rapid 80 GK, GS and GA device installation trunking systems as well as in ISS service poles with a 76.5 mm system opening.



St G

Protective conductor connection bracket

Type	Surface		Pack Piece	Weight kg/100 pc.	Item no.
8AWR	Electrogalvanised		10	0.610	6288704

Protective conductor connection bracket to include steel and aluminium device installation trunking, service poles and system components of underfloor duct systems in the protective measure.
Clamping area: 2 x 1.5–4 mm²

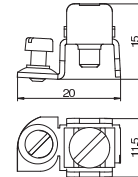

Device installation trunking Rapid 80, trunking width 170, trunking height 70, asymmetrical, double

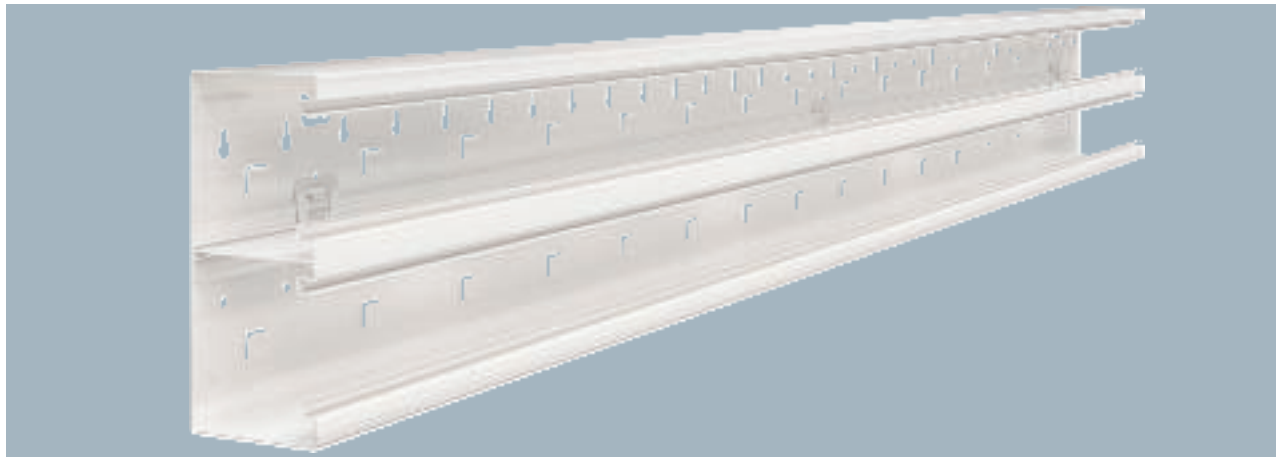

Type	Colour	Length mm	Pack m	Weight kg/100 m	Item no.
GS-D70170RW	Pure white	2000	8	382.000	6278200

GS device installation trunking for mounting on the wall or on fastening panels. The GS device installation trunking possesses self-contacting locking straps to accept a sheet steel partition. The equipotential bonding between the trunking bases takes place using the trunking coupling. The protective measure and the equipotential bonding is guaranteed between the cover and the base by the self-contacting trunking cover. The real system opening for device installation is 76.5 mm. The second trunking track with a system opening of 45 mm is used for cable routing. Installation of Modul 45 switching and connection devices is not possible here. The cover must be ordered separately.

Overlengths up to 3,000 mm for trunking bases and covers as well as other RAL colours can be provided on request. The visible surfaces of the painted device installation trunking are laminated.

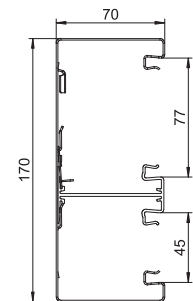

Coupling GS-KUP70

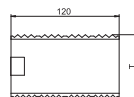

Type	Length mm	Pack PU	Weight kg/100 PUs	Item no.
GS-KUP70	120	1	6.400	6277290

Coupling for connecting the trunking bases. This creates the equipotential bonding between the trunking bases. The scope of delivery of a coupling includes 2 connection plates.



PA



Accessory mounting box 71GD6, single

Type	Colour	Pack Piece	Weight kg/100 pc.	Item no.
71GD6	Iron grey	5	5.600	6288610

Front locking accessory mounting box for switch systems, with folding, and also removable, base for time-saving cable connection, with feed openings for cable diameters of up to 14 mm. Halogen-free version.

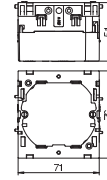

PA

7ZE strain relief

Type	Pack Piece	Weight kg/100 pc.	Item no.
7ZE	50	0.700	6288790

Strain relief with locking clips, suitable for the accessory mounting boxes 7GD... and 71GD... . Cable clamping range to 14 mm.

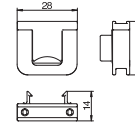

St

Trunking cover, sheet steel

Type	Colour	Length mm	Pack m	Weight kg/100 m	Item no.
GS-OTRW	Pure white	2000	2	65.000	6279850

Cover to close the device installation trunking GEK-S and GEK-A.

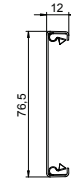

St

Locking bracket RKV3V

Type	Pack Piece	Weight kg/100 pc.	Item no.
RKV3V	20	0.085	6288700

Locking bracket for the mechanical and electrical connection of duct covers and duct bases. Suitable for covers of Rapid 45, Rapid 80 and ISS systems.

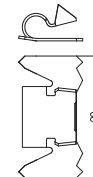

PC / ABS



Flat angle cover, for device installation trunking Rapid 80 type GK-70170

Type	Colour	Length mm	Pack Piece	Weight kg/100 pc.	Item no.
GK-FH70170RW	Pure white	212.5	1	26.150	6274620

Flat angle cover fitting made of halogen-free PC/ABS for simple creation of a rising or falling 90° change of direction with device installation trunking of the series Rapid 80 GK, GKH, GS and GA. The flat angle cover fitting can be used for symmetrical and asymmetrical trunking types.

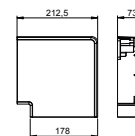

Internal corner cover, for device installation trunking Rapid 80 type GK-70170

PC/ABS

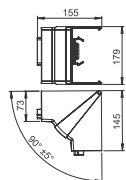



Type	Colour		Pack	Weight	Item no.
			Piece	kg/100 pc.	
GK-IH70170RW	Pure white		1	16.300	6274640

Internal corner cover made of halogen-free PC/ABS for changing the direction of Rapid 80 device installation trunking of the GK, GKH, GS and GA systems. The fittings can be variably adjusted between 85° and 95° and can be used in symmetrical and asymmetrical trunking.

End piece, for device installation trunking Rapid 80 type GS-S70170

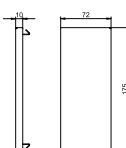
St



Type	Colour		Pack	Weight	Item no.
			Piece	kg/100 pc.	
GS-E70170RW	Pure white		1	12.900	6277670

End piece for GS device installation trunking.

Partition GS-TW70

St

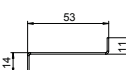

Type	Length		Pack	Weight	Item no.
	mm	Suitable for duct depth	m	kg/100 m	
GS-TW70	2000	70	2	58.650	6277090

Partition to divide the trunking for different voltage levels. Self-conducting contacting during mounting.

Partition GS-TW90

St

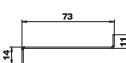

Type	Length		Pack	Weight	Item no.
	mm	Suitable for duct depth	m	kg/100 m	
GS-TW90	2000	90	2	74.400	6277095

Partition to divide the trunking for different voltage levels. Self-conducting contacting during mounting.

Duct clamp KL80A

PC/ABS

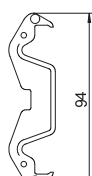

Type	Colour		Pack	Weight	Item no.
			Piece	kg/100 pc.	
KL80A	Light grey		20	0.685	6288640

Duct clamp for holding cables securely and for fastening the partition in Rapid 80 GK, GS and GA device installation trunking systems as well as in ISS service poles with a 76.5 mm system opening.

Trunking height 70 and 90 mm, trunking width 170 mm, duoduct

St G

Protective conductor connection bracket

Type	Surface	Pack Piece	Weight kg/100 pc.	Item no.
8AWR	Electrogalvanised	10	0.610	6288704

Protective conductor connection bracket to include steel and aluminium device installation trunking, service poles and system components of underfloor duct systems in the protective measure.
Clamping area: 2 x 1.5–4 mm²

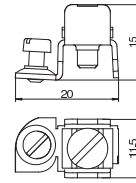

Trunking height 70 and 90 mm, trunking width 210 mm, asymmetrical

VA

Coupling GS-KUP70

Type	Length mm	Pack PU	Weight kg/100 PUs	Item no.
GS-KUP70	120	1	6.400	6277290

Coupling for connecting the trunking bases. This creates the equipotential bonding between the trunking bases.
The scope of delivery of a coupling includes 2 connection plates.

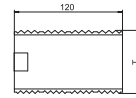

PA



Accessory mounting box 71GD6, single

Type	Colour	Pack Piece	Weight kg/100 pc.	Item no.
71GD6	Iron grey	5	5.600	6288610

Front locking accessory mounting box for switch systems, with folding, and also removable, base for time-saving cable connection, with feed openings for cable diameters of up to 14 mm. Halogen-free version.

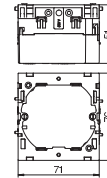

PA

7ZE strain relief

Type	Pack Piece	Weight kg/100 pc.	Item no.
7ZE	50	0.700	6288790

Strain relief with locking clips, suitable for the accessory mounting boxes 7GD... and 71GD...
Cable clamping range to 14 mm.

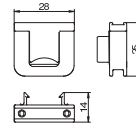

St

Trunking cover, sheet steel

Type	Colour	Length mm	Pack m	Weight kg/100 m	Item no.
GS-OTRW	Pure white	2000	2	65.000	6279850

Cover to close the device installation trunking GEK-S and GEK-A.

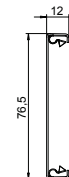

Locking bracket RKV3V

St

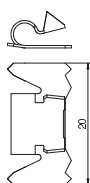

Type	Pack Piece	Weight kg/100 pc.	Item no.
RKV3V	20	0.085	6288700

Locking bracket for the mechanical and electrical connection of duct covers and duct bases. Suitable for covers of Rapid 45, Rapid 80 and ISS systems.

Plastic trunking cover, smooth

PVC

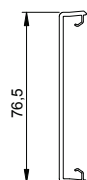

Type	Colour	Length mm	Pack m	Weight kg/100 m	Item no.
GK-OTGRW	Pure white	2000	16	27.500	6278680

Smooth trunking cover, for closing device installation trunking with 76.5 mm system opening.

External corner cover, smooth

PVC

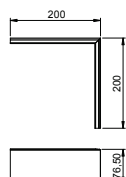

Type	Colour	Pack Piece	Weight kg/100 pc.	Item no.
GK-OTGARW	Pure white	2	9.500	6274790

PVC external corner cover, smooth surface.

Flat angle cover, smooth

PVC

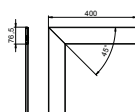

Type	Colour	Pack Piece	Weight kg/100 pc.	Item no.
GK-OTGFRW	Pure white	1	17.000	6274490

PVC flat angle cover, smooth surface.

Partition GS-TW70

St



Type	Length mm	Suitable for duct depth	Pack m	Weight kg/100 m	Item no.
GS-TW70	2000	70	2	58.650	6277090

Partition to divide the trunking for different voltage levels. Self-conducting contacting during mounting.

St

Partition GS-TW90

Type	Length		Pack	Weight	Item no.
	mm	Suitable for duct depth			
GS-TW90	2000	90	2	74.400	6277095

Partition to divide the trunking for different voltage levels. Self-conducting contacting during mounting.

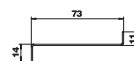

PC / ABS

Duct clamp KL80A

Type	Colour	Pack	Weight	Item no.
KL80A	Light grey	20	0.685	6288640

Duct clamp for holding cables securely and for fastening the partition in Rapid 80 GK, GS and GA device installation trunking systems as well as in ISS service poles with a 76.5 mm system opening.



St G

Protective conductor connection bracket

Type	Surface	Pack	Weight	Item no.
8AWR	Electrogalvanised	10	0.610	6288704

Protective conductor connection bracket to include steel and aluminium device installation trunking, service poles and system components of underfloor duct systems in the protective measure.
Clamping area: 2 x 1.5–4 mm²

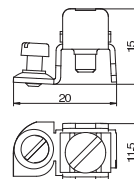

Device installation trunking Rapid 80, trunking width 210, trunking height 70, symmetrical, double

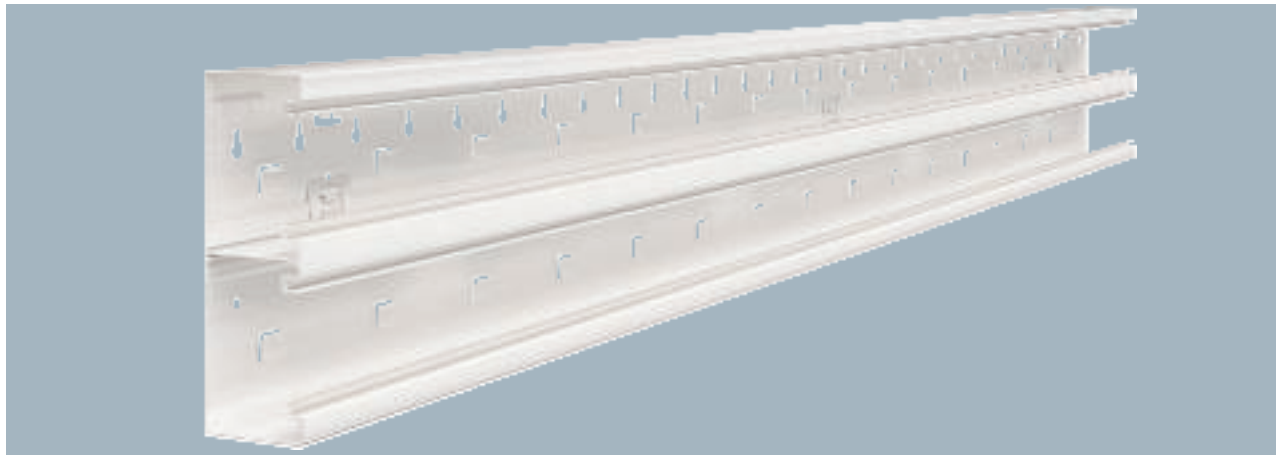

Type	Colour	Length mm	Pack m	Weight kg/100 m	Item no.
GS-D70210RW	Pure white	2000	8	420.000	6278400

GS device installation trunking for mounting on the wall or on fastening panels. The GS device installation trunking possesses self-contacting locking straps to accept a sheet steel partition. The equipotential bonding between the trunking bases takes place using the trunking coupler. The protective measure and the equipotential bonding is guaranteed between the cover and the base by the self-contacting trunking cover. The real system opening is 76.5 mm.

Overlengths up to 3,000 mm for trunking bases and covers as well as other RAL colours can be provided on request. The visible surfaces of the painted device installation trunking are laminated.

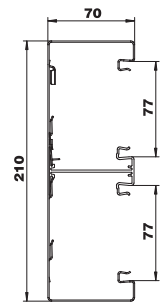

Coupling GS-KUP70

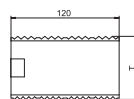

Type	Length mm	Pack PU	Weight kg/100 PUs	Item no.
GS-KUP70	120	1	6.400	6277290

Coupling for connecting the trunking bases. This creates the equipotential bonding between the trunking bases. The scope of delivery of a coupling includes 2 connection plates.

Accessory mounting box 71GD6, single

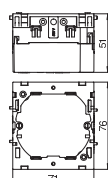

Type	Colour	Pack Piece	Weight kg/100 pc.	Item no.
71GD6	Iron grey	5	5.600	6288610

Front locking accessory mounting box for switch systems, with folding, and also removable, base for time-saving cable connection, with feed openings for cable diameters of up to 14 mm. Halogen-free version.

PA

7ZE strain relief

Type	Pack Piece	Weight kg/100 pc.	Item no.
7ZE	50	0.700	6288790

Strain relief with locking clips, suitable for the accessory mounting boxes 7GD... and 71GD...
Cable clamping range to 14 mm.

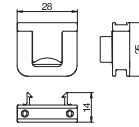

St

Trunking cover, sheet steel

Type	Colour	Length mm	Pack m	Weight kg/100 m	Item no.
GS-OTRW	Pure white	2000	2	65.000	6279850

Cover to close the device installation trunking GEK-S and GEK-A.

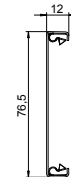

St

Locking bracket RKV3V

Type	Pack Piece	Weight kg/100 pc.	Item no.
RKV3V	20	0.085	6288700

Locking bracket for the mechanical and electrical connection of duct covers and duct bases. Suitable for covers of Rapid 45, Rapid 80 and ISS systems.



PVC

Plastic trunking cover, smooth

Type	Colour	Length mm	Pack m	Weight kg/100 m	Item no.
GK-OTGRW	Pure white	2000	16	27.500	6278680

Smooth trunking cover, for closing device installation trunking with 76.5 mm system opening.

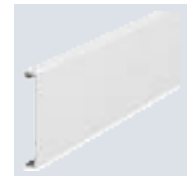
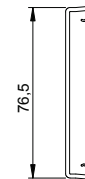

PVC

External corner cover, smooth

Type	Colour	Pack Piece	Weight kg/100 pc.	Item no.
GK-OTGARW	Pure white	2	9.500	6274790

PVC external corner cover, smooth surface.

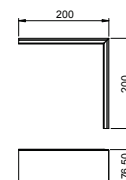

Flat angle cover, smooth

PVC

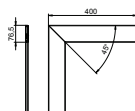

Type	Colour	Pack Piece	Weight kg/100 pc.	Item no.
GK-OTGFRW	Pure white	1	17.000	6274490

PVC flat angle cover, smooth surface.

Partition GS-TW70

St

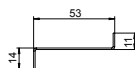

Type	Length mm	Suitable for duct depth	Pack m	Weight kg/100 m	Item no.
GS-TW70	2000	70	2	58.650	6277090

Partition to divide the trunking for different voltage levels. Self-conducting contacting during mounting.

Partition GS-TW90

St

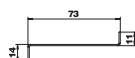

Type	Length mm	Suitable for duct depth	Pack m	Weight kg/100 m	Item no.
GS-TW90	2000	90	2	74.400	6277095

Partition to divide the trunking for different voltage levels. Self-conducting contacting during mounting.

Duct clamp KL80A

PC/ABS

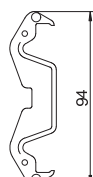

Type	Colour	Pack Piece	Weight kg/100 pc.	Item no.
KL80A	Light grey	20	0.685	6288640

Duct clamp for holding cables securely and for fastening the partition in Rapid 80 GK, GS and GA device installation trunking systems as well as in ISS service poles with a 76.5 mm system opening.

Protective conductor connection bracket

St G

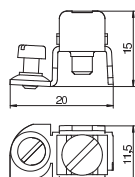

Type	Surface	Pack Piece	Weight kg/100 pc.	Item no.
8AWR	Electrogalvanised	10	0.610	6288704

Protective conductor connection bracket to include steel and aluminium device installation trunking, service poles and system components of underfloor duct systems in the protective measure. Clamping area: 2 x 1.5–4 mm²

PA



Accessory mounting box 71GD6, single

Type	Colour	Pack Piece	Weight kg/100 pc.	Item no.
71GD6	Iron grey	5	5.600	6288610

Front locking accessory mounting box for switch systems, with folding, and also removable, base for time-saving cable connection, with feed openings for cable diameters of up to 14 mm. Halogen-free version.

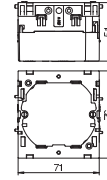

PA

Type	Pack Piece	Weight kg/100 pc.	Item no.
7ZE	50	0.700	6288790

Strain relief with locking clips, suitable for the accessory mounting boxes 7GD... and 71GD... . Cable clamping range to 14 mm.

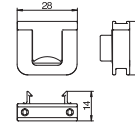

7ZE strain relief

St

Type	Colour	Length mm	Pack m	Weight kg/100 m	Item no.
GS-OTRW	Pure white	2000	2	65.000	6279850

Cover to close the device installation trunking GEK-S and GEK-A.

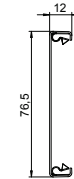

Trunking cover, sheet steel

St

Type	Pack Piece	Weight kg/100 pc.	Item no.
RKV3V	20	0.085	6288700

Locking bracket for the mechanical and electrical connection of duct covers and duct bases. Suitable for covers of Rapid 45, Rapid 80 and ISS systems.

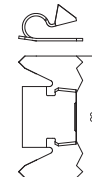

Locking bracket RKV3V

PVC

Type	Colour	Length mm	Pack m	Weight kg/100 m	Item no.
GK-OTGRW	Pure white	2000	16	27.500	6278680

Smooth trunking cover, for closing device installation trunking with 76.5 mm system opening.

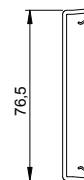

Plastic trunking cover, smooth



Protective conductor connection bracket

St G

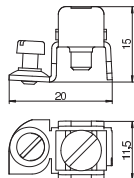

Surface		Pack	Weight	Item no.
Type		Piece	kg/100 pc.	
8AWR	Electrogalvanised	10	0.610	6288704

Protective conductor connection bracket to include steel and aluminium device installation trunking, service poles and system components of underfloor duct systems in the protective measure.
Clamping area: 2 x 1.5–4 mm²





Aluminium device installation trunking Rapid 80

Installation principle



1	Device installation trunking	GA-S	11	T piece	GA-T
2	Coupling	GA-KUP	12	End piece	GA-E
3	Single accessory mounting box	71GD	13	Partition	GA-TW
4	Double accessory mounting box	71GD	14	Duct clamp	KL80A
5	Trunking cover	GA-OT			
6	External corner	GA-SA			
7	External corner cover	GA-OTA			
8	Flat angle	GA-SF			
9	Flat angle cover	GA-OTFA			
10	Internal corner	GA-SI			

Alu EL

Device installation trunking Rapid 80, trunking width 110, trunking height 70

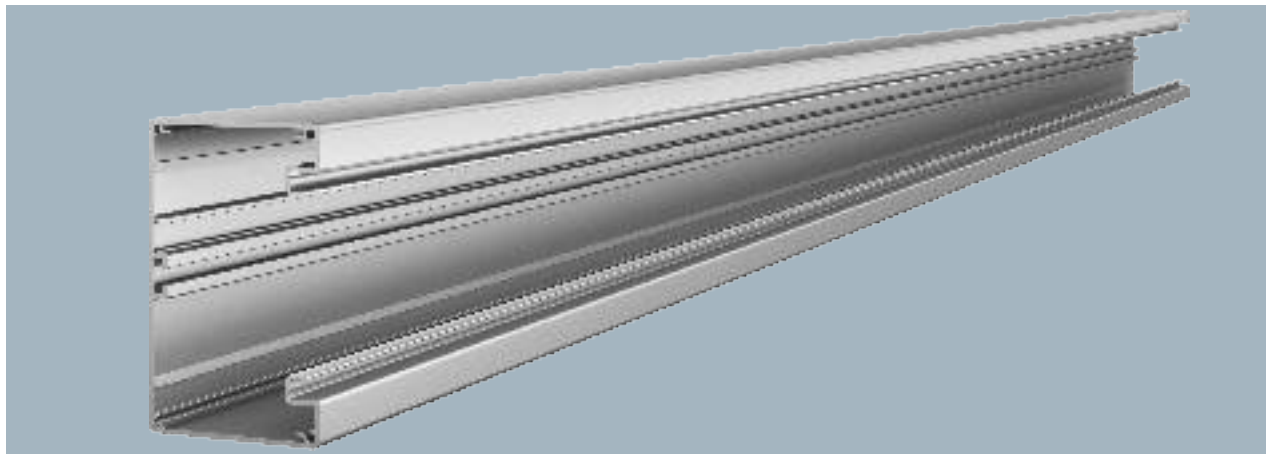

Device installation trunking without base perforation for direct wall mounting or mounting on panels. Over-lengths up to 6,000 mm for trunking bases and covers as well as other RAL colours can be provided on request. The visible surfaces of the painted device installation trunking are laminated.

Note:

For anodised device installation trunking and fittings made from aluminium, light colour differences caused by tolerance based on the material and process conditions, cannot be avoided (according to DIN 17 611). Alternatively, we recommend powder coating in the colour RAL 9006 (white aluminium).

Type	Colour	Surface	Length mm	Pack m	Weight kg/100 m	Item no.
GA-S70110EL	—	Anodised	2000	12	198.200	6279203
GA-S70110RW	Pure white	—	2000	12	198.200	6279200

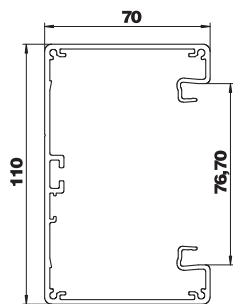

VA

Coupling GA-KUP70

Type	Trunking height mm	Pack PU	Weight kg/100 PUs	Item no.
GA-KUP70	70	1	5.800	6279701

Joint connector for connecting the bases of Rapid 80 GA aluminium device installation trunking. The scope of delivery of a coupling includes 2 connection plates.

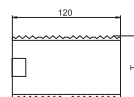

PA



Accessory mounting box 71GD6, single

Type	Colour	Pack Piece	Weight kg/100 pc.	Item no.
71GD6	Iron grey	5	5.600	6288610

Front locking accessory mounting box for switch systems, with folding, and also removable, base for time-saving cable connection, with feed openings for cable diameters of up to 14 mm. Halogen-free version.

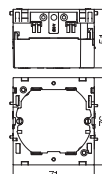

7ZE strain relief

PA

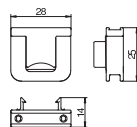

Type	Pack Piece	Weight kg/100 pc.	Item no.
7ZE	50	0.700	6288790

Strain relief with locking clips, suitable for the accessory mounting boxes 7GD... and 71GD...
Cable clamping range to 14 mm.

Cover, for device installation trunking Rapid 80

Alu EL

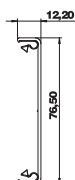

Type	Colour	Surface	Length mm	Pack m	Weight kg/100 m	Item no.
GA-OTRW	Pure white	—	2000	2	38.300	6279720
GA-OTEL	—	Anodised	2000	2	38.300	6279723

Aluminium cover, for closing Rapid GA device installation duct and ISS service poles with a 76.5 mm system opening. The firm position of the cover and electrical contact to the lower part of the duct and service pole is guaranteed thanks to type RKV3V locking brackets. There are 6 pre-mounted locking brackets included per delivery length (2,000 mm).

Note:

For anodised device installation trunking and fittings made from aluminium, light colour differences caused by tolerance based on the material and process conditions, cannot be avoided (according to DIN 17 611). Alternatively, we recommend powder coating in the colour RAL 9006 (white aluminium).

Locking bracket RKV3V

St

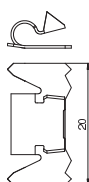

Type	Pack Piece	Weight kg/100 pc.	Item no.
RKV3V	20	0.085	6288700

Locking bracket for the mechanical and electrical connection of duct covers and duct bases. Suitable for covers of Rapid 45, Rapid 80 and ISS systems.

End piece, for device installation trunking Rapid 80 type GA-S70110

Alu EL

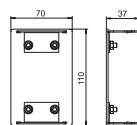

Type	Colour	Surface	Pack Piece	Weight kg/100 pc.	Item no.
GA-E70110EL	—	Anodised	1	11.200	6279273
GA-E70110RW	Pure white	—	1	11.200	6279270

End piece for tidy closure of the Rapid 80 GA device installation trunking in aluminium.

End piece, for device installation trunking Rapid 80 type GK-70110

PVC PC/ABS

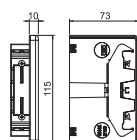

Type	Colour	Pack Piece	Weight kg/100 pc.	Item no.
GK-E70110RW	Pure white	1	5.009	6274370
GK-E70110WA	White aluminium	1	4.900	6274374

End piece for closing the GK device installation trunking.

St

Partition GA-TW70

Type	Length mm	Pack m	Weight kg/100 m	Item no.
GA-TW70	2000	2	51.500	6279711

Partition to divide the Rapid 80 GA, Rapid IBIS aluminium device installation trunking and ISS service poles for the installation of different voltage levels.
For vertical mounting of device installation trunking and the installation of ISS service poles, the duct clamps, type KL80A, are required for secure fixing of the partition.

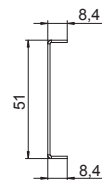

PC / ABS

Duct clamp KL80A

Type	Colour	Pack Piece	Weight kg/100 pc.	Item no.
KL80A	Light grey	20	0.685	6288640

Duct clamp for holding cables securely and for fastening the partition in Rapid 80 GK, GS and GA device installation trunking systems as well as in ISS service poles with a 76.5 mm system opening.



St G

Protective conductor connection bracket

Type	Surface	Pack Piece	Weight kg/100 pc.	Item no.
8AWR	Electrogalvanised	10	0.610	6288704

Protective conductor connection bracket to include steel and aluminium device installation trunking, service poles and system components of underfloor duct systems in the protective measure.
Clamping area: 2 x 1.5–4 mm²

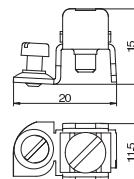

Device installation trunking Rapid 80, trunking width 130, trunking height 70

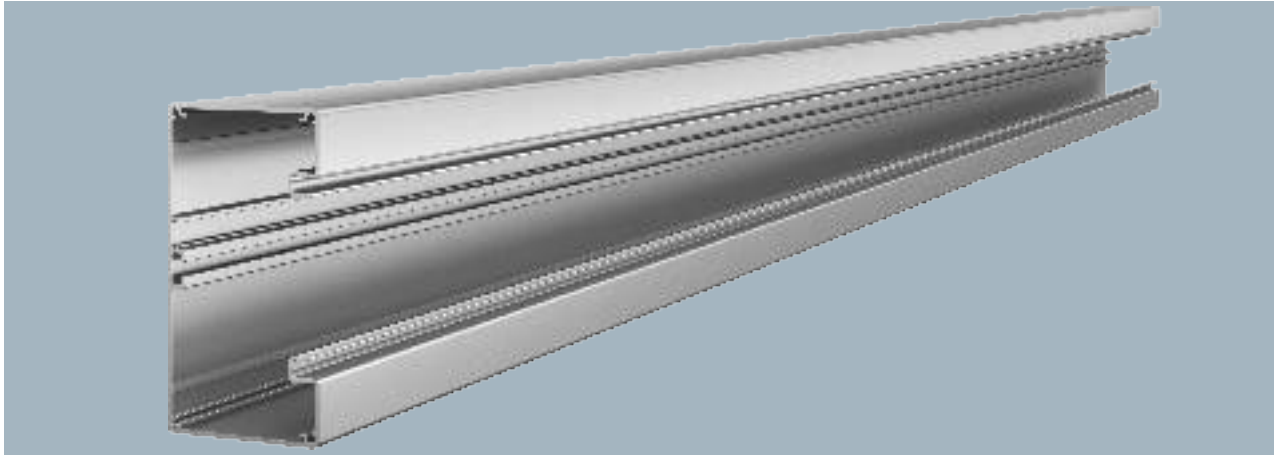

Type	Colour	Surface	Length mm	Pack m	Weight kg/100 m	Item no.
GA-S70130EL	—	Anodised	2000	12	219.700	6279303
GA-S70130RW	Pure white	—	2000	12	219.700	6279300

Device installation trunking without base perforation for direct wall mounting or mounting on panels. Over-lengths up to 6,000 mm for trunking bases and covers as well as other RAL colours can be provided on request. The visible surfaces of the painted device installation trunking are laminated.

Note:

For anodised device installation trunking and fittings made from aluminium, light colour differences caused by tolerance based on the material and process conditions, cannot be avoided (according to DIN 17 611). Alternatively, we recommend powder coating in the colour RAL 9006 (white aluminium).

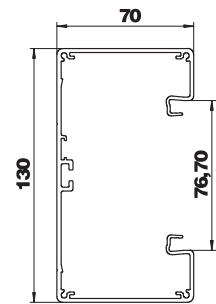

Alu EL

Device installation trunking Rapid 80, trunking width 130, trunking height 90, symmetrical

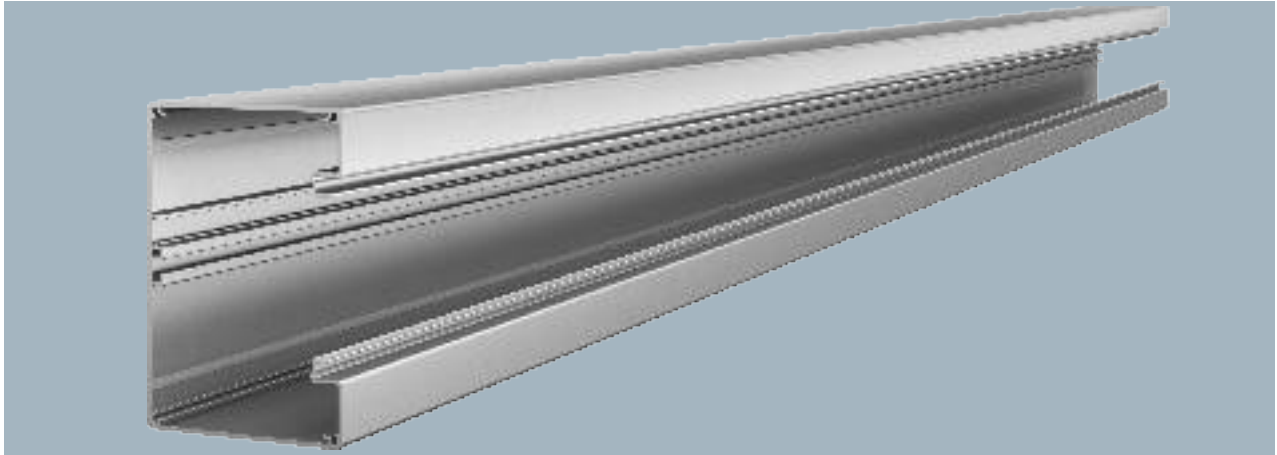

Device installation trunking Without base perforation for direct wall mounting or mounting on panels. Over-lengths up to 6,000 mm for trunking bases and covers as well as other RAL colours can be provided on request. The visible surfaces of the painted device installation trunking are laminated.

Note:

For anodised device installation trunking and fittings made from aluminium, light colour differences caused by tolerance based on the material and process conditions, cannot be avoided (according to DIN 17 611). Alternatively, we recommend powder coating in the colour RAL 9006 (white aluminium).

Type	Colour	Surface	Length mm	Pack m	Weight kg/100 m	Item no.
GA-S90130EL	—	Anodised	2000	8	241.300	6276903
GA-S90130RW	Pure white	—	2000	8	241.300	6276900

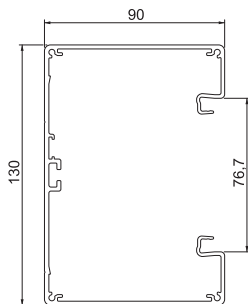

VA

Coupling GA-KUP70

Type	Trunking height mm	Pack PU	Weight kg/100 PUs	Item no.
GA-KUP70	70	1	5.800	6279701

Joint connector for connecting the bases of Rapid 80 GA aluminium device installation trunking. The scope of delivery of a coupling includes 2 connection plates.

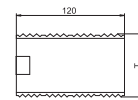

VA

Coupling GA-KUP90

Type	Trunking height mm	Pack PU	Weight kg/100 PUs	Item no.
GA-KUP90	90	1	8.200	6279704

Joint connector for connecting the bases of Rapid 80 GA aluminium device installation trunking. The scope of delivery of a coupling includes 2 connection plates.

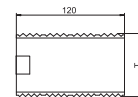

Accessory mounting box 71GD6, single

PA

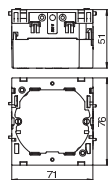

Type	Colour	Pack Piece	Weight kg/100 pc.	Item no.
71GD6	Iron grey	5	5.600	6288610

Front locking accessory mounting box for switch systems, with folding, and also removable, base for time-saving cable connection, with feed openings for cable diameters of up to 14 mm. Halogen-free version.

7ZE strain relief

PA

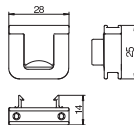

Type	Pack Piece	Weight kg/100 pc.	Item no.
7ZE	50	0.700	6288790

Strain relief with locking clips, suitable for the accessory mounting boxes 7GD... and 71GD... . Cable clamping range to 14 mm.

Cover, for device installation trunking Rapid 80

Alu EL

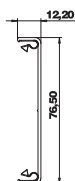

Type	Colour	Surface	Length mm	Pack m	Weight kg/100 m	Item no.
GA-OTRW	Pure white	—	2000	2	38.300	6279720
GA-OTEL	—	Anodised	2000	2	38.300	6279723

Aluminium cover, for closing Rapid GA device installation duct and ISS service poles with a 76.5 mm system opening. The firm position of the cover and electrical contact to the lower part of the duct and service pole is guaranteed thanks to type RKV3V locking brackets. There are 6 pre-mounted locking brackets included per delivery length (2,000 mm).

Note:

For anodised device installation trunking and fittings made from aluminium, light colour differences caused by tolerance based on the material and process conditions, cannot be avoided (according to DIN 17 611). Alternatively, we recommend powder coating in the colour RAL 9006 (white aluminium).

End piece, for device installation trunking Rapid 80 type GA-S70130

Alu EL

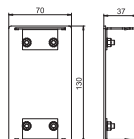

Type	Colour	Surface	Length mm	Pack Piece	Weight kg/100 pc.	Item no.
GA-E70130EL	—	Anodised	37	1	11.900	6279373
GA-E70130RW	Pure white	—	37	1	11.900	6279370

End piece for tidy closure of the Rapid 80 GA device installation trunking in aluminium.

End piece, for device installation trunking Rapid 80 type GA-S90130

Alu EL

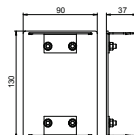

Type	Colour	Surface	Length mm	Pack Piece	Weight kg/100 pc.	Item no.
GA-E90130EL	—	Anodised	37	1	14.500	6276973
GA-E90130RW	Pure white	—	37	1	14.500	6276970

End piece for tidy closure of the Rapid 80 GA device installation trunking in aluminium.

PVC

End piece, for device installation trunking Rapid 80 type GK-70130

Type	Colour	Pack Piece	Weight kg/100 pc.	Item no.
GK-E70130RW	Pure white	1	5.574	6274570

End piece for closing the GK device installation trunking.

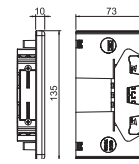

St

Locking bracket RKV3V

Type	Pack Piece	Weight kg/100 pc.	Item no.
RKV3V	20	0.085	6288700

Locking bracket for the mechanical and electrical connection of duct covers and duct bases. Suitable for covers of Rapid 45, Rapid 80 and ISS systems.



St

Partition GA-TW70

Type	Length mm	Pack m	Weight kg/100 m	Item no.
GA-TW70	2000	2	51.500	6279711

Partition to divide the Rapid 80 GA, Rapid IBIS aluminium device installation trunking and ISS service poles for the installation of different voltage levels. For vertical mounting of device installation trunking and the installation of ISS service poles, the duct clamps, type KL80A, are required for secure fixing of the partition.

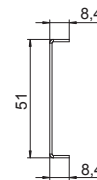

St

Partition, trunking height 90 mm

Type	Length mm	Pack m	Weight kg/100 m	Item no.
GA-TW90	2000	2	67.300	6279714

Partition to divide the Rapid 80 GA and Rapid IBIS aluminium device installation trunking and ISS service poles for the installation of different voltage levels.

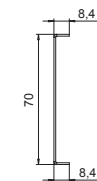

PC / ABS

Duct clamp KL80A

Type	Colour	Pack Piece	Weight kg/100 pc.	Item no.
KL80A	Light grey	20	0.685	6288640

Duct clamp for holding cables securely and for fastening the partition in Rapid 80 GK, GS and GA device installation trunking systems as well as in ISS service poles with a 76.5 mm system opening.



Protective conductor connection bracket

St G

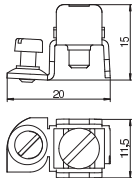

Type	Surface	Pack Piece	Weight kg/100 pc.	Item no.
8AWR	Electrogalvanised	10	0.610	6288704

Protective conductor connection bracket to include steel and aluminium device installation trunking, service poles and system components of underfloor duct systems in the protective measure.
Clamping area: 2 x 1.5–4 mm²

Alu EL

Device installation trunking Rapid 80, trunking width 170, trunking height 70, symmetrical

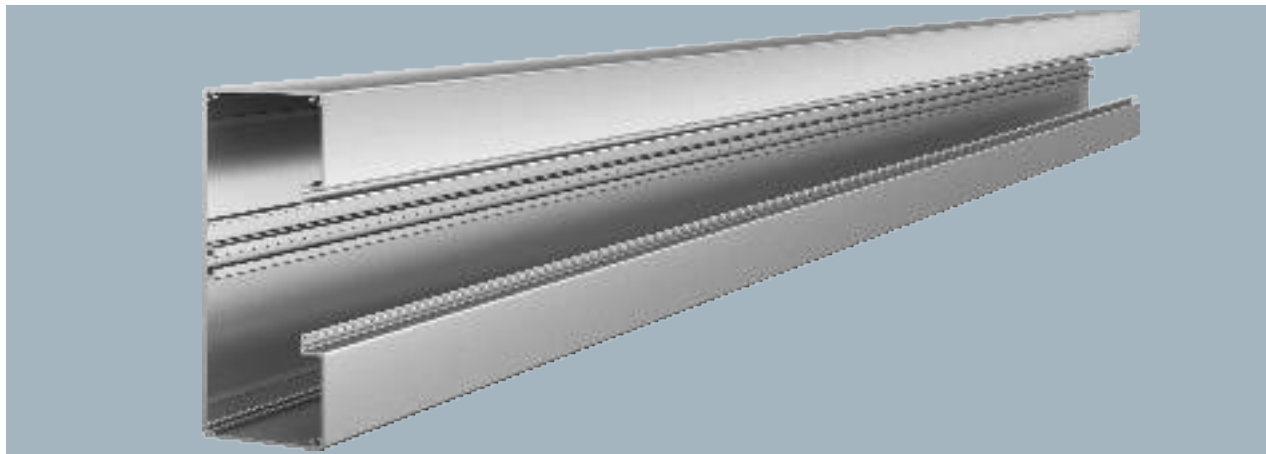

Device installation trunking without base perforation for direct wall mounting or mounting on panels. Over-lengths up to 6,000 mm for trunking bases and covers as well as other RAL colours can be provided on request. The visible surfaces of the painted device installation trunking are laminated.

Note:

For anodised device installation trunking and fittings made from aluminium, light colour differences caused by tolerance based on the material and process conditions, cannot be avoided (according to DIN 17 611). Alternatively, we recommend powder coating in the colour RAL 9006 (white aluminium).

Type	Colour	Surface	Length mm	Pack m	Weight kg/100 m	Item no.
GA-S70170EL	—	Anodised	2000	8	262.900	6279103
GA-S70170RW	Pure white	—	2000	8	262.900	6279100

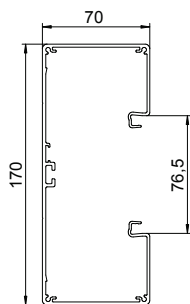

VA

Coupling GA-KUP70

Type	Trunking height mm	Pack PU	Weight kg/100 PUs	Item no.
GA-KUP70	70	1	5.800	6279701

Joint connector for connecting the bases of Rapid 80 GA aluminium device installation trunking. The scope of delivery of a coupling includes 2 connection plates.

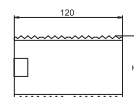

PA



Accessory mounting box 71GD6, single

Type	Colour	Pack Piece	Weight kg/100 pc.	Item no.
71GD6	Iron grey	5	5.600	6288610

Front locking accessory mounting box for switch systems, with folding, and also removable, base for time-saving cable connection, with feed openings for cable diameters of up to 14 mm. Halogen-free version.

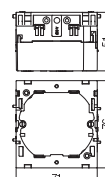

7ZE strain relief

PA

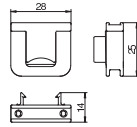

Type	Pack Piece	Weight kg/100 pc.	Item no.
7ZE	50	0.700	6288790

Strain relief with locking clips, suitable for the accessory mounting boxes 7GD... and 71GD...
Cable clamping range to 14 mm.

Cover, for device installation trunking Rapid 80

Alu EL

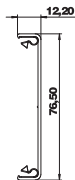

Type	Colour	Surface	Length mm	Pack m	Weight kg/100 m	Item no.
GA-OTRW	Pure white	—	2000	2	38.300	6279720
GA-OTEL	—	Anodised	2000	2	38.300	6279723

Aluminium cover, for closing Rapid GA device installation duct and ISS service poles with a 76.5 mm system opening. The firm position of the cover and electrical contact to the lower part of the duct and service pole is guaranteed thanks to type RKV3V locking brackets. There are 6 pre-mounted locking brackets included per delivery length (2,000 mm).

Note:

For anodised device installation trunking and fittings made from aluminium, light colour differences caused by tolerance based on the material and process conditions, cannot be avoided (according to DIN 17 611). Alternatively, we recommend powder coating in the colour RAL 9006 (white aluminium).

Locking bracket RKV3V

St

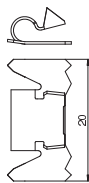

Type	Pack Piece	Weight kg/100 pc.	Item no.
RKV3V	20	0.085	6288700

Locking bracket for the mechanical and electrical connection of duct covers and duct bases. Suitable for covers of Rapid 45, Rapid 80 and ISS systems.

End piece, for device installation trunking Rapid 80 type GA-70170

Alu EL

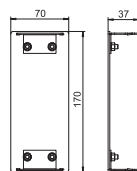

Type	Colour	Surface	Length mm	Pack Piece	Weight kg/100 pc.	Item no.
GA-E70170EL	—	Anodised	37	1	13.400	6279473
GA-E70170RW	Pure white	—	37	1	13.400	6279470

End piece for tidy closure of the Rapid 80 GA device installation trunking in aluminium.

End piece, for device installation trunking Rapid 80 type GK-70170

PVC

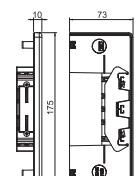

Type	Colour	Pack Piece	Weight kg/100 pc.	Item no.
GK-E70170RW	Pure white	1	6.840	6274770

End piece for closing the GK device installation trunking.

St

Partition GA-TW70

Type	Length mm	Pack m	Weight kg/100 m	Item no.
GA-TW70	2000	2	51.500	6279711

Partition to divide the Rapid 80 GA, Rapid IBIS aluminium device installation trunking and ISS service poles for the installation of different voltage levels.
For vertical mounting of device installation trunking and the installation of ISS service poles, the duct clamps, type KL80A, are required for secure fixing of the partition.

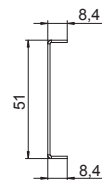

PC / ABS

Duct clamp KL80A

Type	Colour	Pack Piece	Weight kg/100 pc.	Item no.
KL80A	Light grey	20	0.685	6288640

Duct clamp for holding cables securely and for fastening the partition in Rapid 80 GK, GS and GA device installation trunking systems as well as in ISS service poles with a 76.5 mm system opening.



St G

Protective conductor connection bracket

Type	Surface	Pack Piece	Weight kg/100 pc.	Item no.
8AWR	Electrogalvanised	10	0.610	6288704

Protective conductor connection bracket to include steel and aluminium device installation trunking, service poles and system components of underfloor duct systems in the protective measure.
Clamping area: 2 x 1.5–4 mm²

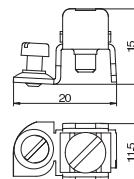

Trunking height 70 mm, trunking width 170 mm, asymmetrical

Alu EL

Device installation trunking Rapid 80, trunking width 170, trunking height 70, asymmetrical

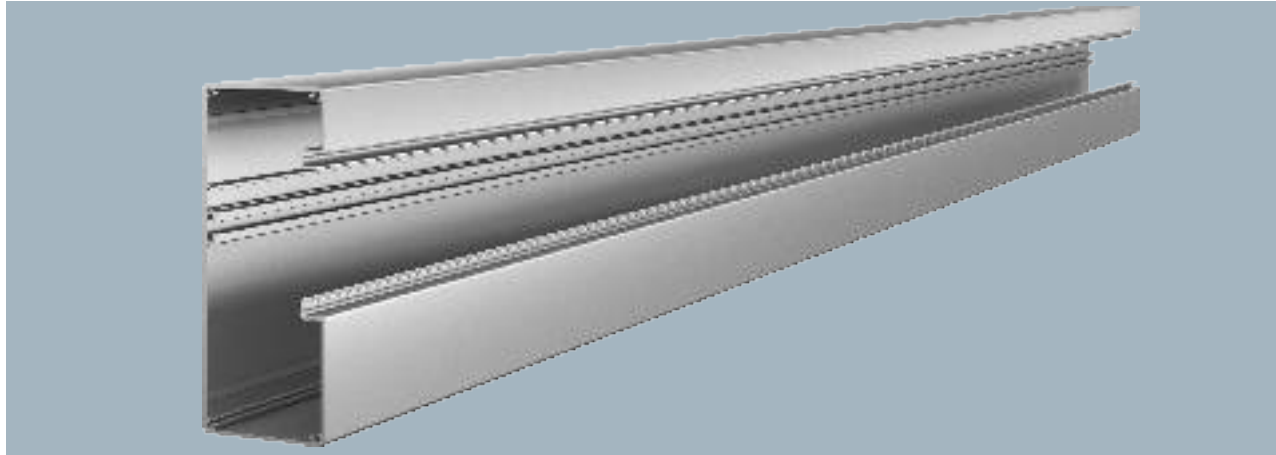

Type	Colour	Surface	Length mm	Pack m	Weight kg/100 m	Item no.
GA-A70170EL	—	Anodised	2000	8	262.900	6279403
GA-A70170RW	Pure white	—	2000	8	262.900	6279400

Device installation trunking without base perforation for direct wall mounting or mounting on panels. Over-lengths up to 6,000 mm for trunking bases and covers as well as other RAL colours can be provided on request. The visible surfaces of the painted device installation trunking are laminated.

Note:

For anodised device installation trunking and fittings made from aluminium, light colour differences caused by tolerance based on the material and process conditions, cannot be avoided (according to DIN 17 611). Alternatively, we recommend powder coating in the colour RAL 9006 (white aluminium).

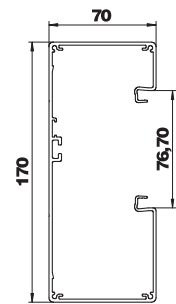

Coupling GA-KUP70

VA

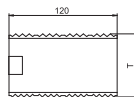

Type	Trunking height mm	Pack PU	Weight kg/100 PUs	Item no.
GA-KUP70	70	1	5.800	6279701

Joint connector for connecting the bases of Rapid 80 GA aluminium device installation trunking. The scope of delivery of a coupling includes 2 connection plates.

Accessory mounting box 71GD6, single

PA

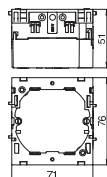

Type	Colour	Pack Piece	Weight kg/100 pc.	Item no.
71GD6	Iron grey	5	5.600	6288610

Front locking accessory mounting box for switch systems, with folding, and also removable, base for time-saving cable connection, with feed openings for cable diameters of up to 14 mm. Halogen-free version.

PA

7ZE strain relief

Type	Pack Piece	Weight kg/100 pc.	Item no.
7ZE	50	0.700	6288790

Strain relief with locking clips, suitable for the accessory mounting boxes 7GD... and 71GD...
Cable clamping range to 14 mm.

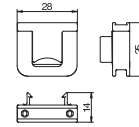

Alu EL

Cover, for device installation trunking Rapid 80

Type	Colour	Surface	Length mm	Pack m	Weight kg/100 m	Item no.
GA-OTRW	Pure white	—	2000	2	38.300	6279720
GA-OTEL	—	Anodised	2000	2	38.300	6279723

Aluminium cover, for closing Rapid GA device installation duct and ISS service poles with a 76.5 mm system opening. The firm position of the cover and electrical contact to the lower part of the duct and service pole is guaranteed thanks to type RKV3V locking brackets. There are 6 pre-mounted locking brackets included per delivery length (2,000 mm).

Note:

For anodised device installation trunking and fittings made from aluminium, light colour differences caused by tolerance based on the material and process conditions, cannot be avoided (according to DIN 17 611). Alternatively, we recommend powder coating in the colour RAL 9006 (white aluminium).

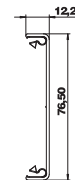

St

Locking bracket RKV3V

Type	Pack Piece	Weight kg/100 pc.	Item no.
RKV3V	20	0.085	6288700

Locking bracket for the mechanical and electrical connection of duct covers and duct bases. Suitable for covers of Rapid 45, Rapid 80 and ISS systems.

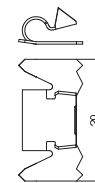

Alu EL

End piece, for device installation trunking Rapid 80 type GA-70170

Type	Colour	Surface	Length mm	Pack Piece	Weight kg/100 pc.	Item no.
GA-E70170EL	—	Anodised	37	1	13.400	6279473
GA-E70170RW	Pure white	—	37	1	13.400	6279470

End piece for tidy closure of the Rapid 80 GA device installation trunking in aluminium.

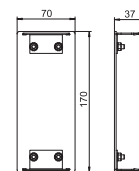

PVC

End piece, for device installation trunking Rapid 80 type GK-70170

Type	Colour	Pack Piece	Weight kg/100 pc.	Item no.
GK-E70170RW	Pure white	1	6.840	6274770

End piece for closing the GK device installation trunking.

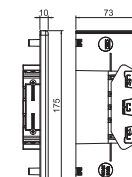

Partition GA-TW70

St

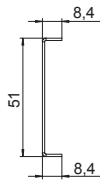

Type	Length mm	Pack	Weight	Item no.
		m	kg/100 m	
GA-TW70	2000	2	51.500	6279711

Partition to divide the Rapid 80 GA, Rapid IBIS aluminium device installation trunking and ISS service poles for the installation of different voltage levels.

For vertical mounting of device installation trunking and the installation of ISS service poles, the duct clamps, type KL80A, are required for secure fixing of the partition.

Duct clamp KL80A

PC/
ABS

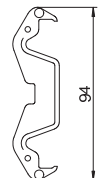

Type	Colour	Pack	Weight	Item no.
		Piece	kg/100 pc.	
KL80A	Light grey	20	0.685	6288640

Duct clamp for holding cables securely and for fastening the partition in Rapid 80 GK, GS and GA device installation trunking systems as well as in ISS service poles with a 76.5 mm system opening.

Protective conductor connection bracket

St G

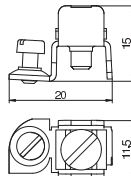

Type	Surface	Pack	Weight	Item no.
		Piece	kg/100 pc.	
8AWR	Electrogalvanised	10	0.610	6288704

Protective conductor connection bracket to include steel and aluminium device installation trunking, service poles and system components of underfloor duct systems in the protective measure.
Clamping area: 2 x 1.5–4 mm²

Alu EL

Device installation trunking Rapid 80, trunking width 170, trunking height 90



Device installation trunking Without base perforation for direct wall mounting or mounting on panels. Over-lengths up to 6,000 mm for trunking bases and covers as well as other RAL colours can be provided on request. The visible surfaces of the painted device installation trunking are laminated.

Note:

For anodised device installation trunking and fittings made from aluminium, light colour differences caused by tolerance based on the material and process conditions, cannot be avoided (according to DIN 17 611). Alternatively, we recommend powder coating in the colour RAL 9006 (white aluminium).

Type	Colour	Surface	Length mm	Pack m	Weight kg/100 m	Item no.
GA-A90170RW	Pure white	—	2000	6	284.500	6279500
GA-A90170EL	—	Anodised	2000	6	284.500	6279503

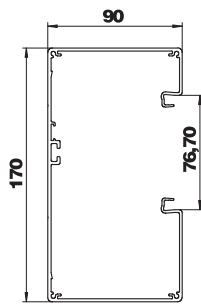

Alu EL

End piece, for device installation trunking Rapid 80 type GA-90170

Type	Colour	Surface	Pack Piece	Weight kg/100 pc.	Item no.
GA-E90170RW	Pure white	—	1	16.900	6279570
GA-E90170EL	—	Anodised	1	16.900	6279573

End piece for tidy closure of the Rapid 80 GA device installation trunking in aluminium.

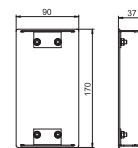

Device installation trunking Rapid 80, trunking width 210, trunking height 90

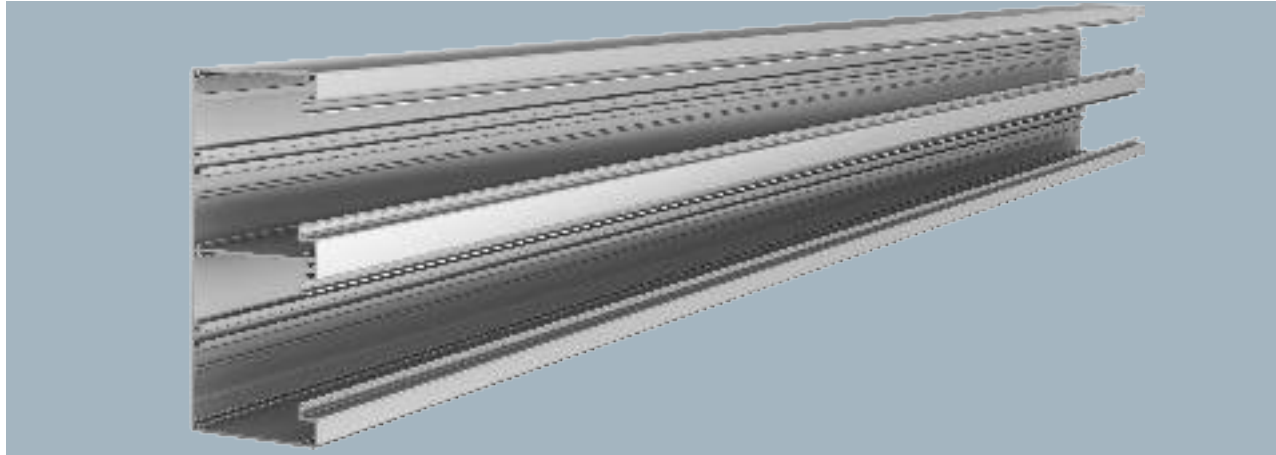

Type	Colour	Surface	Length mm	Pack m	Weight kg/100 m	Item no.
GA-D90210EL	—	Anodised	2000	6	378.600	6279603
GA-D90210RW	Pure white	—	2000	6	378.600	6279600

Device installation trunking without base perforation for direct wall mounting or mounting on panels. Over-lengths up to 6,000 mm for trunking bases and covers as well as other RAL colours can be provided on request. The visible surfaces of the painted device installation trunking are laminated.

Note:

For anodised device installation trunking and fittings made from aluminium, light colour differences caused by tolerance based on the material and process conditions, cannot be avoided (according to DIN 17 611). Alternatively, we recommend powder coating in the colour RAL 9006 (white aluminium).

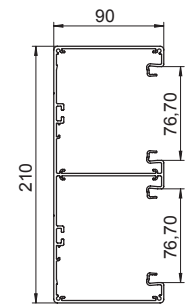

Coupling GA-KUP90

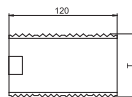

Type	Trunking height mm	Pack PU	Weight kg/100 PUs	Item no.
GA-KUP90	90	1	8.200	6279704

Joint connector for connecting the bases of Rapid 80 GA aluminium device installation trunking. The scope of delivery of a coupling includes 2 connection plates.

Accessory mounting box 71GD6, single

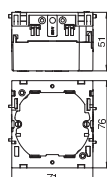

Type	Colour	Pack Piece	Weight kg/100 pc.	Item no.
71GD6	Iron grey	5	5.600	6288610

Front locking accessory mounting box for switch systems, with folding, and also removable, base for time-saving cable connection, with feed openings for cable diameters of up to 14 mm. Halogen-free version.

PA

7ZE strain relief

Type	Pack Piece	Weight kg/100 pc.	Item no.
7ZE	50	0.700	6288790

Strain relief with locking clips, suitable for the accessory mounting boxes 7GD... and 71GD...
Cable clamping range to 14 mm.

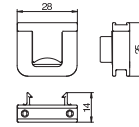

Alu EL

Cover, for device installation trunking Rapid 80

Type	Colour	Surface	Length mm	Pack m	Weight kg/100 m	Item no.
GA-OTRW	Pure white	—	2000	2	38.300	6279720
GA-OTEL	—	Anodised	2000	2	38.300	6279723

Aluminium cover, for closing Rapid GA device installation duct and ISS service poles with a 76.5 mm system opening. The firm position of the cover and electrical contact to the lower part of the duct and service pole is guaranteed thanks to type RKV3V locking brackets. There are 6 pre-mounted locking brackets included per delivery length (2,000 mm).

Note:

For anodised device installation trunking and fittings made from aluminium, light colour differences caused by tolerance based on the material and process conditions, cannot be avoided (according to DIN 17 611). Alternatively, we recommend powder coating in the colour RAL 9006 (white aluminium).

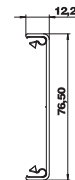

St

Locking bracket RKV3V

Type	Pack Piece	Weight kg/100 pc.	Item no.
RKV3V	20	0.085	6288700

Locking bracket for the mechanical and electrical connection of duct covers and duct bases. Suitable for covers of Rapid 45, Rapid 80 and ISS systems.

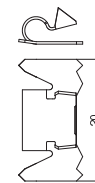

Alu EL

End piece, for device installation trunking Rapid 80 type GA-90210

Type	Colour	Surface	Pack Piece	Weight kg/100 pc.	Item no.
GA-E90210EL	—	Anodised	1	18.800	6279673
GA-E90210RW	Pure white	—	1	18.800	6279670

End piece for tidy closure of the Rapid 80 GA device installation trunking in aluminium.

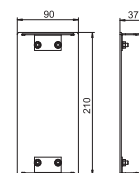

St

Partition GA-TW70

Type	Length mm	Pack m	Weight kg/100 m	Item no.
GA-TW70	2000	2	51.500	6279711

Partition to divide the Rapid 80 GA, Rapid IBIS aluminium device installation trunking and ISS service poles for the installation of different voltage levels.
For vertical mounting of device installation trunking and the installation of ISS service poles, the duct clamps, type KL80A, are required for secure fixing of the partition.

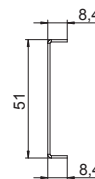

Partition, trunking height 90 mm

St

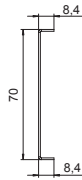
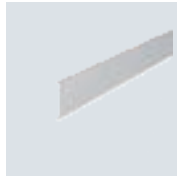

Type	Length mm	Pack m	Weight kg/100 m	Item no.
GA-TW90	2000	2	67.300	6279714

Partition to divide the Rapid 80 GA and Rapid IBIS aluminium device installation trunking and ISS service poles for the installation of different voltage levels.

Duct clamp KL80A

PC/
ABS

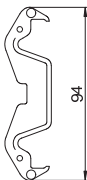

Type	Colour	Pack Piece	Weight kg/100 pc.	Item no.
KL80A	Light grey	20	0.685	6288640

Duct clamp for holding cables securely and for fastening the partition in Rapid 80 GK, GS and GA device installation trunking systems as well as in ISS service poles with a 76.5 mm system opening.

Protective conductor connection bracket

St G

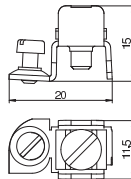

Type	Surface	Pack Piece	Weight kg/100 pc.	Item no.
8AWR	Electrogalvanised	10	0.610	6288704

Protective conductor connection bracket to include steel and aluminium device installation trunking, service poles and system components of underfloor duct systems in the protective measure.
Clamping area: 2 x 1.5–4 mm²

A real eye-catcher.

Design device installation trunking



From the outside, the design device installation trunking from OBO only presents a fine front of anodised aluminium whilst, on the inside, it offers plenty of space for accessories. Connectors, power supplies and data and network connections vanish behind the swivellable cover, which is available in three shapes.



- Elegant, anodised aluminium
- Three different trunking covers
- Swivellable cover
- Concealed device installation based on Modul 45®
- Wide range of system accessories

GAD design device installation trunking

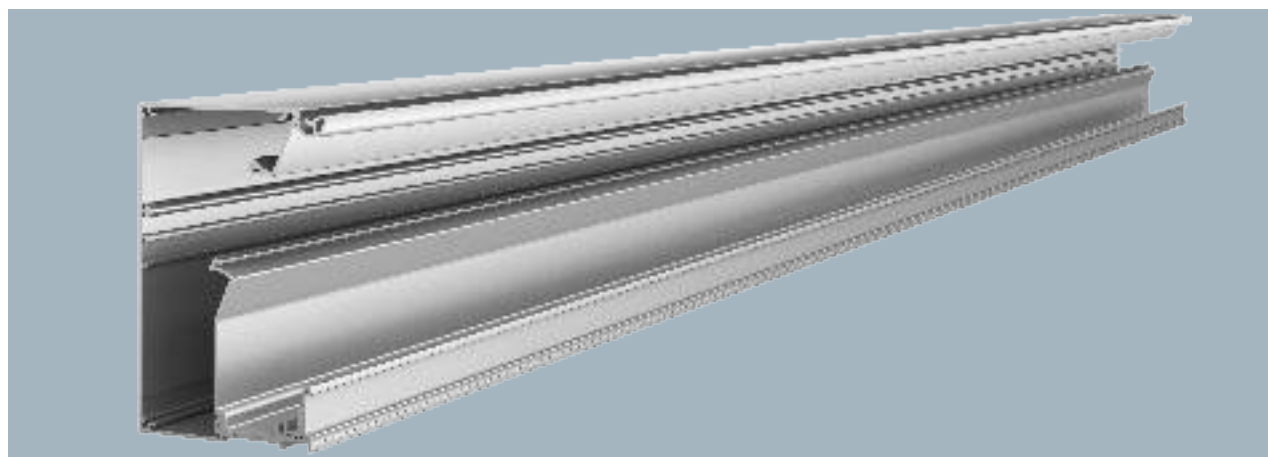

Type	Surface	Length mm	Pack m	Weight kg/100 m	Item no.
GAD UEL	Anodised	2000	2	292.750	6115775

Base to create design device installation trunking of the GAD series. 45 mm system opening for acceptance of Modul 45 switch and connection devices and appropriate PVC and aluminium covers of the Rapid 45 series. The trunking base can be completed with trunking covers in the "Swing", "Soft" or "Style" design. The GAD OTA cover adapters are essential and must be planned on the trunking section with a max. spacing of 50 cm. A GAD OTD spacer must be placed between the trunking covers. In the as-delivered state, the 45 mm system is closed off with a black trunking cover.

Standard version in anodised aluminium, different decoration on request.

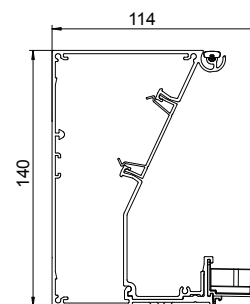

Swing trunking cover, design trunking

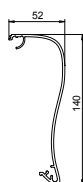

Type	Surface	Length mm	Pack Piece	Weight kg/100 pc.	Item no.
OT GAD Swing EL	Anodised	1000	1	126.100	6115825

Trunking cover to create a design device installation trunking of the GAD series. "Swing" design version for complete coverage of the system opening and the switching and plug-in devices. The GAD OTA cover adapters are essential and must be planned on the trunking section with a max. spacing of 50 cm. A GAD OTD spacer must be placed between the trunking covers.

Standard version in anodised aluminium, different decoration on request.

Soft trunking cover, design trunking

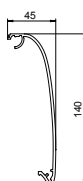

Type	Surface	Length mm	Pack Piece	Weight kg/100 pc.	Item no.
OT GAD Soft EL	Anodised	1000	1	124.900	6115835

Trunking cover to create a design device installation trunking of the GAD series. "Soft" design version for complete coverage of the system opening and the switching and plug-in devices. The GAD OTA cover adapters are essential and must be planned on the trunking section with a max. spacing of 50 cm. A GAD OTD spacer must be placed between the trunking covers.

Standard version in anodised aluminium, different decoration on request.

Alu EL

Style trunking cover, design trunking

Type	Surface	Length mm	Pack Piece	Weight kg/100 pc.	Item no.
OT GAD Style EL	Anodised	1000	1	125.000	6115845

Trunking cover to create a design device installation trunking of the GAD series. "Style" design version for complete coverage of the system opening and the switching and plug-in devices. The GAD OTA cover adapters are essential and must be planned on the trunking section with a max. spacing of 50 cm. A GAD OTD spacer must be placed between the trunking covers.

Standard version in anodised aluminium, different decoration on request.

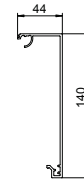

Alu EL

External corner, design trunking

Type	Surface	Pack Piece	Weight kg/100 pc.	Item no.
GAD AEL	Anodised	1	233.000	6115789

External corner base to create a design device installation trunking of the GAD series. 45 mm system opening for acceptance of Modul 45 switch and connection devices and appropriate PVC and aluminium covers of the Rapid 45 series. The fitting can be completed with fitting covers in the "Swing", "Soft" or "Style" design. The GAD OTA cover adapters are essential. A GAD OTD spacer must be placed between the trunking covers.

Standard version in anodised aluminium, different decoration on request.

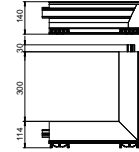

Alu EL

External corner cover, Swing

Type	Surface	Pack Piece	Weight kg/100 pc.	Item no.
OT A Swing EL	Anodised	1	105.900	6115851

Trunking cover for the external corner of the design device installation trunking of the GAD series. "Swing" design version for complete coverage of the system opening and the switching and plug-in devices.

Standard version in anodised aluminium, different decoration on request.

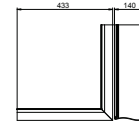

Alu EL

External corner cover, Soft

Type	Surface	Pack Piece	Weight kg/100 pc.	Item no.
OT A Soft EL	Anodised	1	104.600	6115855

Trunking cover for the external corner of the design device installation trunking of the GAD series. "Soft" design version for complete coverage of the system opening and the switching and plug-in devices.

Standard version in anodised aluminium, different decoration on request.

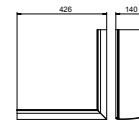

Alu EL

External corner cover, Style

Type	Surface	Pack Piece	Weight kg/100 pc.	Item no.
OT A Style EL	Anodised	1	104.300	6115865

Trunking cover for the external corner of the design device installation trunking of the GAD series. "Style" design version for complete coverage of the system opening and the switching and plug-in devices.

Standard version in anodised aluminium, different decoration on request.

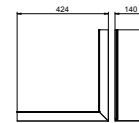

Internal corner, design trunking

Alu EL

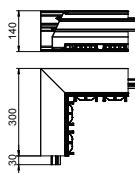

Surface		Pack	Weight	Item no.
Type		Piece	kg/100 pc.	
GAD IEL	Anodised	1	183.000	6115795

Internal corner base to create a design device installation trunking of the GAD series. 45 mm system opening for acceptance of Modul 45 switch and connection devices and appropriate PVC and aluminium covers of the Rapid 45 series. The fitting can be completed with fitting covers in the "Swing", "Soft" or "Style" design. The GAD OTA cover adapters are essential. A GAD OTD spacer must be placed between the trunking covers.

Standard version in anodised aluminium, different decoration on request.

Internal corner cover, Swing

Alu EL

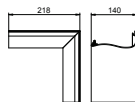

Surface		Pack	Weight	Item no.
Type		Piece	kg/100 pc.	
OT I Swing EL	Anodised	1	45.500	6115875

Trunking cover for the internal corner of the design device installation trunking of the GAD series. "Swing" design version for complete coverage of the system opening and the switching and plug-in devices.

Standard version in anodised aluminium, different decoration on request.

Internal corner cover, Soft

Alu EL

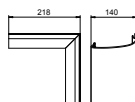

Surface		Pack	Weight	Item no.
Type		Piece	kg/100 pc.	
OT I Soft EL	Anodised	1	46.200	6115885

Trunking cover for the internal corner of the design device installation trunking of the GAD series. "Soft" design version for complete coverage of the system opening and the switching and plug-in devices.

Standard version in anodised aluminium, different decoration on request.

Internal corner cover, Style

Alu EL

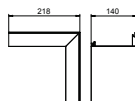

Surface		Pack	Weight	Item no.
Type		Piece	kg/100 pc.	
OT I Style EL	Anodised	1	45.500	6115895

Trunking cover for the internal corner of the design device installation trunking of the GAD series. "Style" design version for complete coverage of the system opening and the switching and plug-in devices.

End piece, Swing, left

Alu EL

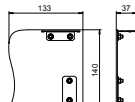

Surface		Pack	Weight	Item no.
Type		Piece	kg/100 pc.	
GAD EL Swing EL	Anodised	1	16.100	6115915

End piece for design device installation trunking of the GAD series. "Swing" design version. The end piece can only be used for closing on the left side.

Standard version in anodised aluminium, different decoration on request.

Alu EL

End piece, Swing, right

Type	Surface	Pack Piece	Weight kg/100 pc.	Item no.
GAD ER Swing EL	Anodised	1	16.100	6115925

End piece for design device installation trunking of the GAD series. "Swing" design version. The end piece can only be used for closing on the right side.
Standard version in anodised aluminium, different decoration on request.

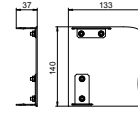

Alu EL

End piece, Soft, left

Type	Surface	Pack Piece	Weight kg/100 pc.	Item no.
GAD EL Soft EL	Anodised	1	15.600	6115935

End piece for design device installation trunking of the GAD series. "Soft" design version. The end piece can only be used for closing on the left side.
Standard version in anodised aluminium, different decoration on request.

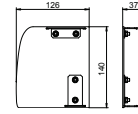

Alu EL

End piece, Soft, right

Type	Surface	Pack Piece	Weight kg/100 pc.	Item no.
GAD ER Soft EL	Anodised	1	15.600	6115945

End piece for design device installation trunking of the GAD series. "Soft" design version. The end piece can only be used for closing on the right side.
Standard version in anodised aluminium, different decoration on request.

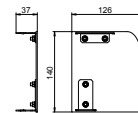

Alu EL

End piece, Style, left

Type	Surface	Pack Piece	Weight kg/100 pc.	Item no.
GAD EL Style EL	Anodised	1	16.200	6115955

End piece for design device installation trunking of the GAD series. "Style" design version. The end piece can only be used for closing on the left side.
Standard version in anodised aluminium, different decoration on request.

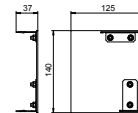

Alu EL

End piece, Style, right

Type	Surface	Pack Piece	Weight kg/100 pc.	Item no.
GAD ER Style EL	Anodised	1	16.200	6115965

End piece for design device installation trunking of the GAD series. "Style" design version. The end piece can only be used for closing on the right side.
Standard version in anodised aluminium, different decoration on request.

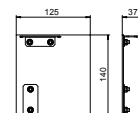

PA

Cover adapter GAD OTA

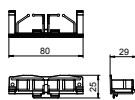

Type	Colour	Pack	Weight	Item no.
		Piece	kg/100 pc.	
GAD OTA	Graphite black	5	0.626	6115975

Cover adapter for mounting on trunking bases and fittings of the GAD and Rapid IBIS design device installation trunking series. The cover adapter can be pushed into a guide on the base and is used to accept the trunking cover and keep it at the desired spacing. It is also used for bundled cable exits and can be moved into the lengthwise direction. A maximum spacing of 500 mm between the cover adapters must be maintained.

Spacer

PA

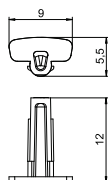

Type	Colour	Pack	Weight	Item no.
		Piece	kg/100 pc.	
GAD OTD RW	Pure white	10	0.008	6115980
GAD OTD LGR	Light grey	10	0.008	6115982
GAD OTD SW	Graphite black	10	0.008	6115985

Spacer for insertion between the trunking covers of the GAD design device installation trunking series. The spacer ensures secure maintenance of a minimum spacing between trunking covers.

Stabiliser plate

St

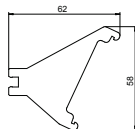

Type	Surface	Pack	Weight	Item no.
		Piece	kg/100 pc.	
GAD SB		10	2.000	6115995

Stabiliser plate for the stabilisation of the system opening of the GAD design device installation trunking series. The panel is placed in the trunking base and supports the acceptance of covers and ensures a secure hold of the devices.

Protective conductor connection bracket

St G

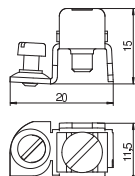

Type	Surface	Pack	Weight	Item no.
		Piece	kg/100 pc.	
8AWR	Electrogalvanised	10	0.610	6288704

Protective conductor connection bracket to include steel and aluminium device installation trunking, service poles and system components of underfloor duct systems in the protective measure. Clamping area: 2 x 1.5–4 mm²

Partition for WDK trunking, trunking height 40 mm

PVC

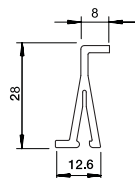

Type	Colour	Length mm	Pack	Weight	Item no.
			m	kg/100 m	
2371 40	Light grey	2000	60	13.500	6023096

Partition to divide the WDK trunking, with 40 mm trunking height, and various ISS service poles for the installation of different voltage levels.

The partitions are pinned on the connectors in the base.



Fastening panels

St FS

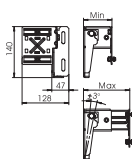

Type	Version	Pack Piece	Weight kg/100 pc.	Item no.
BKN50 80	53-83 mm	1	50.000	6288001
BKN75 125	78-127 mm	1	57.000	6288003
BKN120 205	120-205 mm	1	68.000	6288005
BKN200 350	198-351 mm	1	89.000	6288007

Fastening panel for mounting device installation trunking on skirting board constructions and as a support for the convection grid. The fastening panel can be used for all Rapid 80 device installation trunking systems of type GK, GS and GA. When mounting plastic GK device installation trunking, the matching wall panel adapter is also required. The connection profile is required for mounting double trunking of type GS-D70170 and GS-D90170, as well as for GS trunking with a nominal width of 210 mm.

Simply place the grid lamella on the lamella holders.

Wall panel adapter KS70170 for GK plastic, trunking width 170 mm

St FS

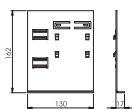

Type	for duct dimension	Pack Piece	Weight kg/100 pc.	Item no.
KS70170	70x170 mm	1	34.300	6279806

Wall panel adapter for mounting the GK70170 device installation trunking on fastening panels.

Profile connector, horizontal

PP

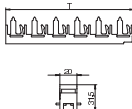

Type	Length mm	Number of profiles	Pack Piece	Weight kg/100 pc.	Item no.
PV N3 50H	50	2	1	0.730	6288100

Horizontal profile connector with guide slits to lock convection grid profiles. The profile connector is mounted on the fastening panel using the clamp, type SP3.

Simply place the grid lamella on the lamella holders.

Clamp

St FS

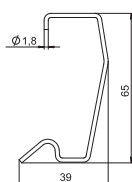

Type	Pack Piece	Weight kg/100 pc.	Item no.
SP3	10	0.260	6279800

Clamp to lock supports between the convection grid and the fixing panel. Suitable for fixing panels for windowsill thickness 23.5 mm

Convection grid profile

Alu

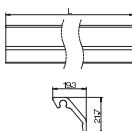

Type	Colour	Surface	Length mm	Pack m	Weight kg/100 m	Item no.
KG2RW	Pure white	-	2000	40	23.100	6287700

Sloping convection grid, for optically attractive closing of spaces between the device installation trunking and the wall. The convection grid profiles are suitable for horizontal and vertical mounting.



Coupling pin 8VS4

Type	Pack Piece	Weight kg/100 pc.	Item no.
8VS4	100	0.740	6287810

Coupling pin to connect convection grid profiles.
Simply place the grid lamella on the lamella holders.



PVC wall cover, open, 70110

ABS/
ASA

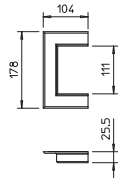

Type	Colour	Pack	Weight	Item no.
		Piece	kg/100 pc.	
G-KWAO70110RW	Pure white	1	6.300	6274810

Wall cover, open, to close wall penetrations during wall mounting.

PVC wall cover, open, 70130

ABS/
ASA

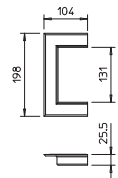

Type	Colour	Pack	Weight	Item no.
		Piece	kg/100 pc.	
G-KWAO70130RW	Pure white	1	6.500	6274820

Wall cover, open, to close wall penetrations during wall mounting.

Spare parts

Strain relief, type 2390/Z8

PVC

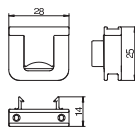

Type	Colour	Pack	Weight	Item no.
		Piece	kg/100 pc.	
2390/Z8	Stone grey	5	0.500	6270727

Strain relief for extensions to accessory mounting boxes
Strain relief suitable for accessory mounting box 2390/8T...



Skirting trunking

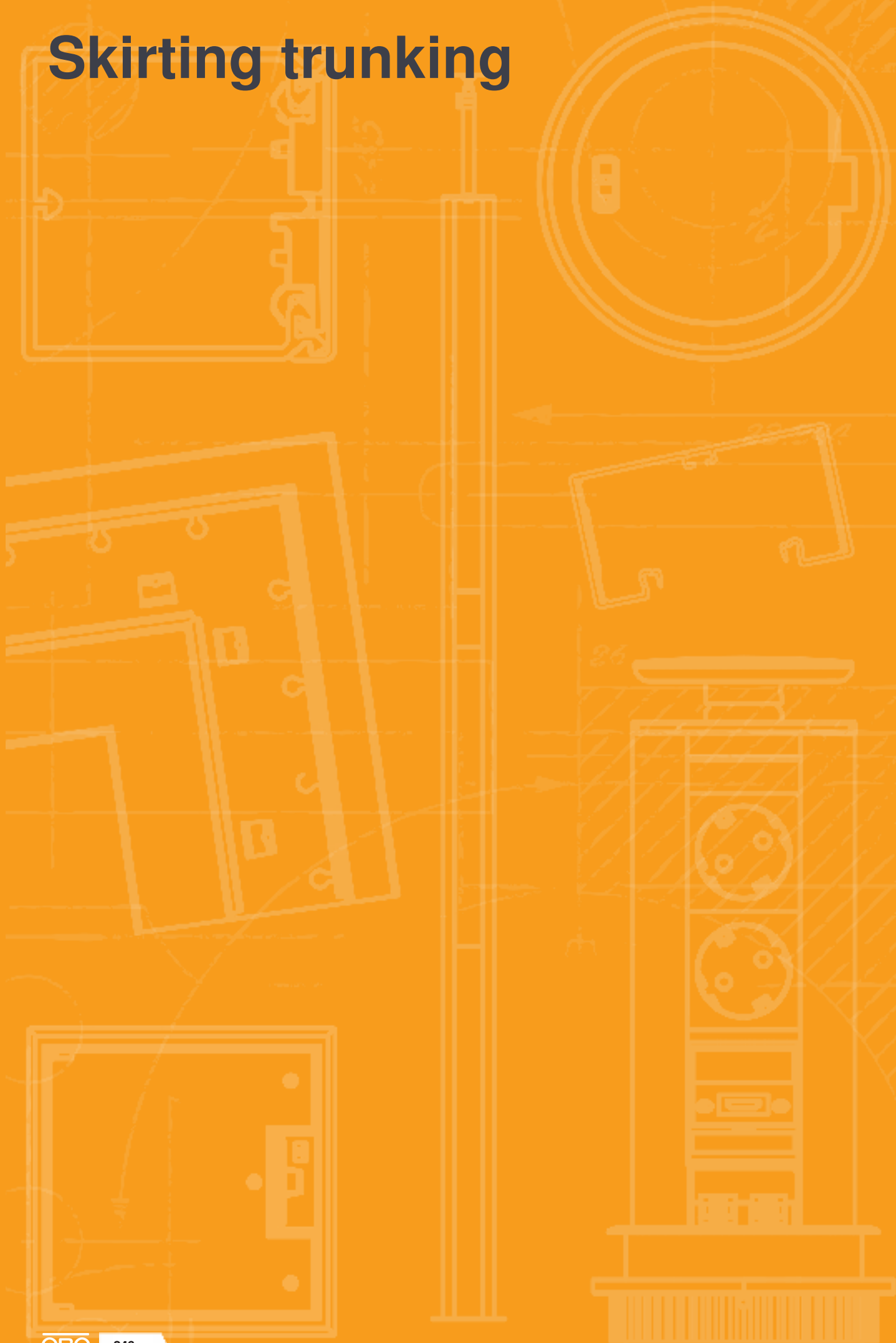

Skirting trunking



Floor trunking, type 2650

Skirting trunking

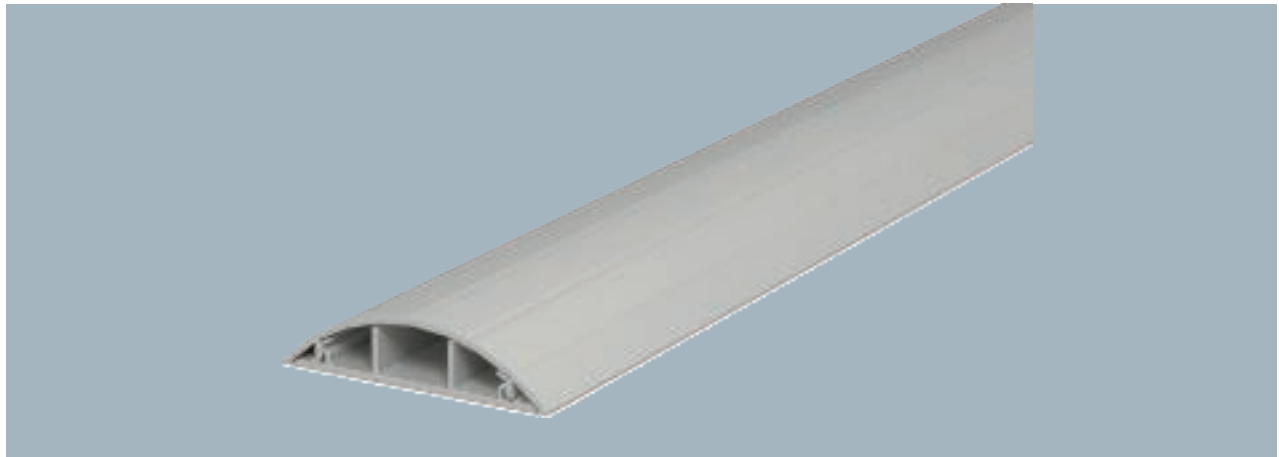

Type	Colour	Length mm	Pack m	Weight kg/100 m	Item no.
2650	Stone grey	2000	36	43.000	6020801

Trunking cover and base with base perforation.

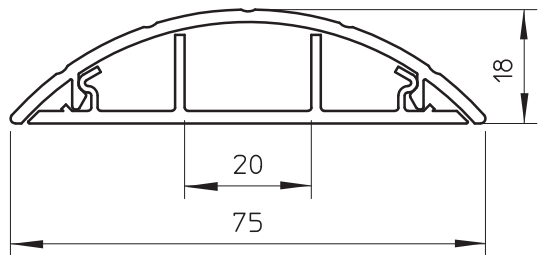



Service poles

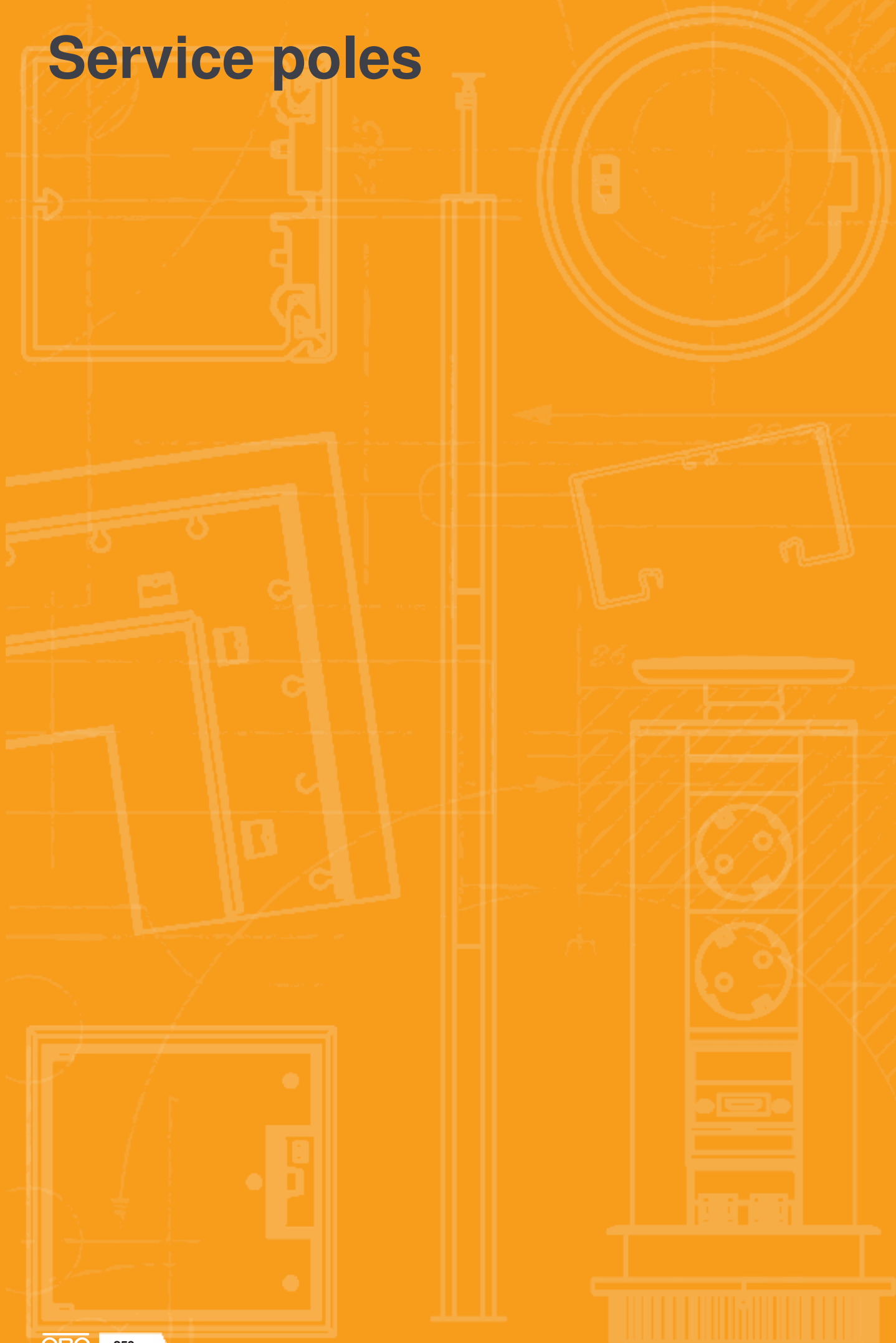

Service poles

	Floor-ceiling service poles	252
	Floor service poles	272
	Accessories, service poles	280



ISS service pole systems

In modern offices, technology must be completely flexible and also aesthetically pleasing. The solution: OBO's service pole systems. They allow free positioning of power supply points near workstations. The location can be changed at any time. This gives both users and architects the greatest possible freedom. In open-plan offices and administrative

buildings, as well as in cash desk areas of shops or in production facilities, they provide more order. ISS service pole systems fulfil all the technical and architectural requirements of modern cable routing and make an active contribution to the interior architecture.



Alu EL

Service pole, type ISST70140

Type	Colour	Surface	Length mm	Pack Piece	Weight kg/100 pc.	Item no.
ISST70140EL	—	Anodised	3006	1	820.000	6288933
ISST70140RW	Pure white	—	3006	1	820.000	6288930

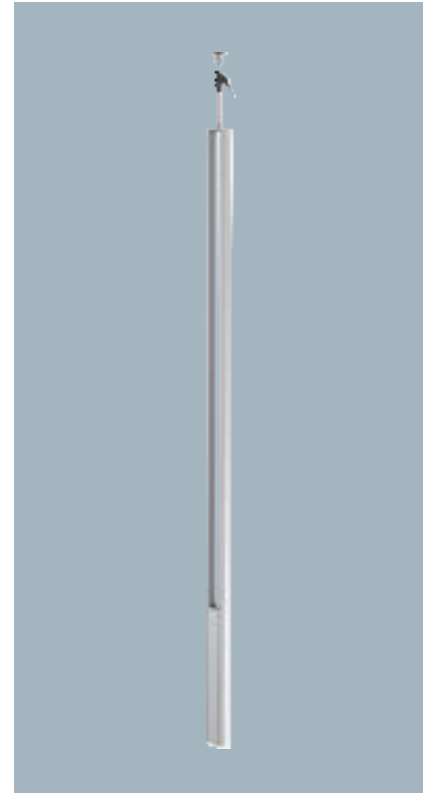

ISS twin aluminium service pole with a 76.5 mm system opening.

Set consists of:

1 single-compartment column with clamping attachment

Total length: 3,315–3,480 mm

1 single-compartment pole with clamping device

1 trunking installation profile

Length 1,000 mm

1 aluminium cover

Length: 1,000 mm

The area for device installation is suitable for accepting front-locking accessory mounting boxes of the series 71GD...

The service pole is pre-mounted and ready for use immediately. The following accessories can be used, depending on the mounting situation.

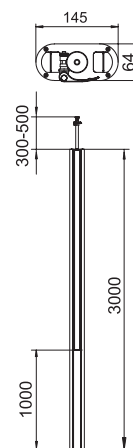

Floor-ceiling service poles, aluminium

Floor plate for ISSOG70140

St FSK

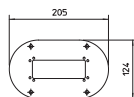

Type	Colour	Pack	Weight	Item no.
		Piece	kg/100 pc.	
ISSBP70140RW	Pure white	1	18.500	6290120
ISSBP70140WA	White aluminium	1	18.500	6290124

Floor plate with 30 mm visible edge and four fastening holes \varnothing 8.5 mm. The floor plate is suitable for mounting service poles of type ISST70140, ISSOG70140 and ISST70140B.

Adapter stabiliser for ISST70140

St FSK

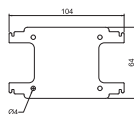

Type	Colour	Pack	Weight	Item no.
		Piece	kg/100 pc.	
ISSZ70140	Pure white	1	8.000	6290160

Adapter stabiliser for additional stiffening of the twin profiles. Suitable for mounting on the service poles of type ISST70140 and ISST70140B.

Rubber support for ISSOG70140

GUM

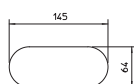

Type	Colour	Pack	Weight	Item no.
		Piece	kg/100 pc.	
ISSGU70140	Black	1	5.000	6290174

Rubber support for slip-free fastening of the floor to ceiling service pole. The rubber support is suitable for installing the service poles of type ISST70140, ISSOG70140 and ISST70140B.

Ceiling panel for ISST70140

St

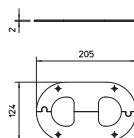

Type	Colour	Pack	Weight	Item no.
		Piece	kg/100 pc.	
WAG70140TRW	Pure white	1	28.600	6290200

Ceiling rosette for tidy closure of the pole penetration in the ceiling. Suitable for service poles, type ISST70140 and ISST70140B.

Alu EL

Service pole, type ISST70140B

Type	Colour	Surface	Length mm	Pack Piece	Weight kg/100 pc.	Item no.
ISST70140BEL	—	Anodised	3006	1	860.000	6290013
ISST70140BRW	Pure white	—	3006	1	860.000	6290010

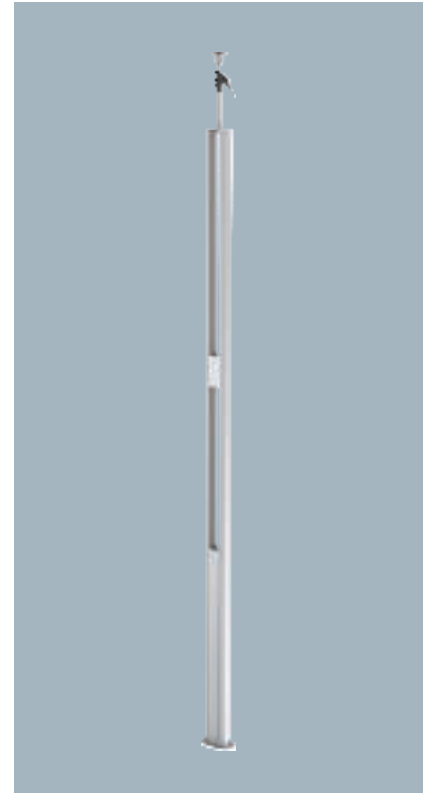

ISS twin aluminium service pole with a 76.5 mm system opening.

Set consists of:

1 single-compartment column with clamp fastening

Total length: 3,315 mm–3,480 mm

1 fastening option for lighting

1 ceiling fastening with clamping device

1 trunking installation profile

Length: 1,000 mm

1 aluminium cover

Length: 1,000 mm

The area for device installation is suitable for accepting front-locking accessory mounting boxes of the series 71GD... The panel to fasten luminaires is attached at a height of 1,850 mm and its own height is 148 mm. It is possible to create various kinds of workplace or general room lighting using the standard wall brackets from lighting manufacturers.

The service pole is pre-mounted and ready for use immediately. The following accessories can be used, depending on the mounting situation.

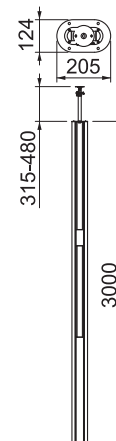

Floor-ceiling service poles, aluminium

Floor plate for ISSOG70140

St FSK

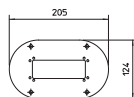

Type	Colour	Pack Piece	Weight kg/100 pc.	Item no.
ISSBP70140RW	Pure white	1	18.500	6290120
ISSBP70140WA	White aluminium	1	18.500	6290124

Floor plate with 30 mm visible edge and four fastening holes \varnothing 8.5 mm. The floor plate is suitable for mounting service poles of type ISST70140, ISSOG70140 and ISST70140B.

Adapter stabiliser for ISST70140

St FSK

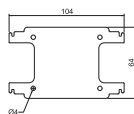

Type	Colour	Pack Piece	Weight kg/100 pc.	Item no.
ISSZ70140	Pure white	1	8.000	6290160

Adapter stabiliser for additional stiffening of the twin profiles. Suitable for mounting on the service poles of type ISST70140 and ISST70140B.

Fastening bracket for ISST70140

St FSK

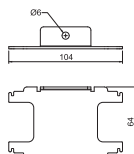

Type	Colour	Pack Piece	Weight kg/100 pc.	Item no.
ISSBW70140RW	Pure white	1	8.500	6290150

Fixing bracket for wall fastening of the twin service pole. Suitable for installation on the service poles of type ISST70140 and ISST70140B.

Rubber support for ISSOG70140

GUM

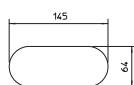

Type	Colour	Pack Piece	Weight kg/100 pc.	Item no.
ISSGU70140	Black	1	5.000	6290174

Rubber support for slip-free fastening of the floor to ceiling service pole. The rubber support is suitable for installing the service poles of type ISST70140, ISSOG70140 and ISST70140B.

Ceiling panel for ISST70140

St

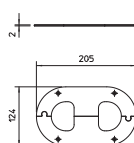

Type	Colour	Pack Piece	Weight kg/100 pc.	Item no.
WAG70140TRW	Pure white	1	28.600	6290200

Ceiling rosette for tidy closure of the pole penetration in the ceiling. Suitable for service poles, type ISST70140 and ISST70140B.

St FSK

Floor plate for ISSOG70140

Type	Colour	Pack Piece	Weight kg/100 pc.	Item no.
ISSBP70140WA	White aluminium	1	18.500	6290124
ISSBP70140RW	Pure white	1	18.500	6290120

Floor plate with 30 mm visible edge and four fastening holes Ø 8.5 mm. The floor plate is suitable for mounting service poles of type ISST70140, ISSOG70140 and ISST70140B.

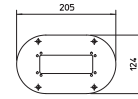

GUM

Rubber support for ISSOG70140

Type	Colour	Pack Piece	Weight kg/100 pc.	Item no.
ISSGU70140	Black	1	5.000	6290174

Rubber support for slip-free fastening of the floor to ceiling service pole. The rubber support is suitable for installing the service poles of type ISST70140, ISSO70140 and ISST70140B.

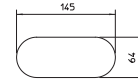

St

Ceiling rosette for ISSOG70140

Type	Colour	Pack Piece	Weight kg/100 pc.	Item no.
WAG701400	Pure white	1	23.400	6290260

Ceiling rosette for tidy closure of the pole penetration in the ceiling. Suitable for service pole, type ISSO70140.

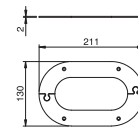

Service pole, type ISS70110

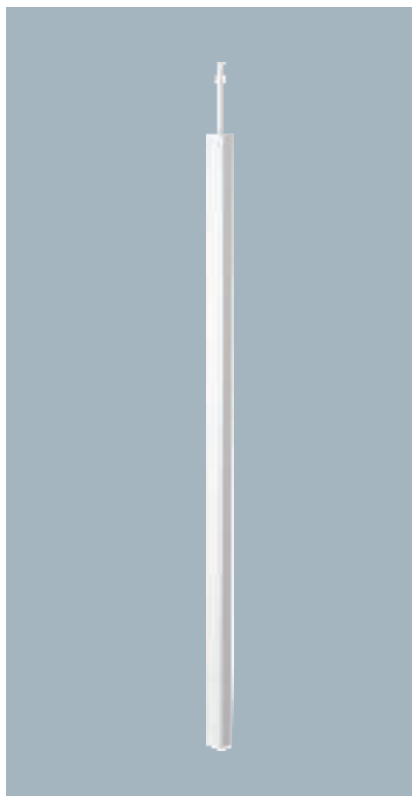

Type	Colour	Surface	Length mm	Pack Piece	Weight kg/100 pc.	Item no.
ISS70110RW	Pure white	—	3003	1	750.000	6288940

ISS aluminium service pole with a 76.5 mm system opening.

Set consists of:

1 single-compartment pole with clamping fastening

Total length 3,315–3,480 mm

1 ceiling attachment with clamp

1 aluminium cover

Length: 3,000 mm

The service pole is suitable for accepting front-locking accessory mounting boxes of the series 71GD... Optionally, a partition, type TW (6288256), and installation of a cover clip, type KL80A (6288640), are possible.

The service pole is pre-mounted and ready for use immediately. The following accessories can be used, depending on the mounting situation.

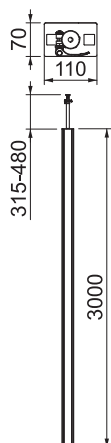

St

Partition GA-TW70

Type	Length mm	Pack m	Weight kg/100 m	Item no.
GA-TW70	2000	2	51.500	6279711

Partition to divide the Rapid 80 GA, Rapid IBIS aluminium device installation trunking and ISS service poles for the installation of different voltage levels.
For vertical mounting of device installation trunking and the installation of ISS service poles, the duct clamps, type KL80A, are required for secure fixing of the partition.

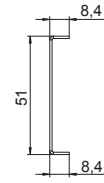

Service pole, type ISS140110



Type	Colour	Surface	Length mm	Pack Piece	Weight kg/100 pc.	Item no.
ISS140110EL	–	Anodised	3006	1	1,710.000	6288963

ISS aluminium service pole with a 76.5 mm system opening.

Set consists of:

1 two-compartment pole with clamping fastening

Total length 3,315–3,480 mm

1 ceiling attachment with clamp

2 aluminium covers

Length: 3,000 mm

The service pole is suitable for accepting front-locking accessory mounting boxes of the series 71 GD... Optionally, a partition, type TW (6288256), and mounting of a cover clip, type KL.80A (6288640), are possible.

The service pole is pre-mounted and ready for use immediately. The following accessories can be used, depending on the mounting situation.

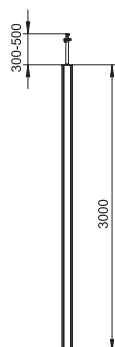

St

Partition GA-TW70

Type	Length mm	Pack m	Weight kg/100 m	Item no.
GA-TW70	2000	2	51.500	6279711

Partition to divide the Rapid 80 GA, Rapid IBIS aluminium device installation trunking and ISS service poles for the installation of different voltage levels.
For vertical mounting of device installation trunking and the installation of ISS service poles, the duct clamps, type KL80A, are required for secure fixing of the partition.

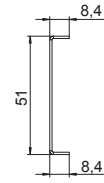

Service pole, type ISSRM45

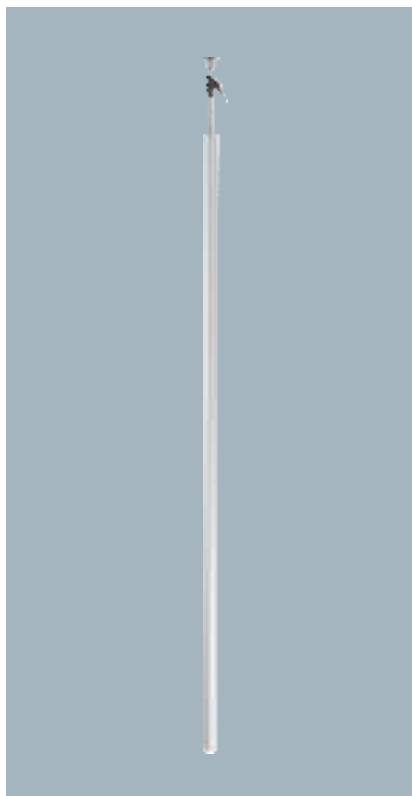

Type	Colour	Surface	Length mm	Pack Piece	Weight kg/100 pc.	Item no.
ISSRM45EL	—	Anodised	3006	1	510.000	6290087
ISSRM45RW	Pure white	—	3006	1	510.000	6290086

ISS aluminium service pole with a 45 mm system opening.

Set consists of:

1 one-compartment pole with clamping fastening

Total length: 3,315 mm–3,480 mm

1 ceiling attachment with clamping device

1 aluminium cover

Length 3,000 mm

The design of this ISS service pole is based on an extremely slender, round aluminium profile, which has a smooth cover of the Rapid 45 device installation trunking series as its front side. The 45 mm system opening is suitable for direct acceptance of Modul 45® switching and connection devices.

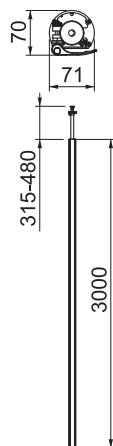

GUM

Rubber support for ISSRM45

Type	Colour	Pack Piece	Weight kg/100 pc.	Item no.
ISSRGU	Black	1	1.450	6290178

Rubber support for slip-free fastening of the floor-ceiling service pole ISSRM45.

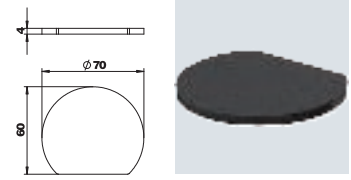

St

Ceiling panel for ISSRM45

Type	Colour	Pack Piece	Weight kg/100 pc.	Item no.
WAGRM45	Pure white	1	12.900	6290264

Closed ceiling rosette for tidy closure of the ceiling gland of the service poles, type ISSRM45.

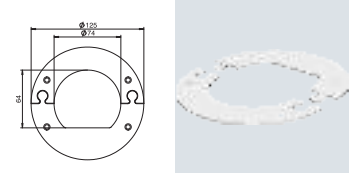

PVC

Partition for WDK trunking, trunking height 40 mm

Type	Colour	Length mm	Pack m	Weight kg/100 m	Item no.
2371 40	Light grey	2000	60	13.500	6023096

Partition to divide the WDK trunking, with 40 mm trunking height, and various ISS service poles for the installation of different voltage levels.

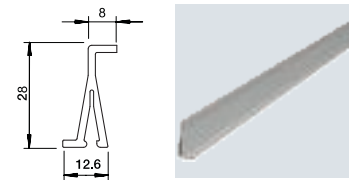

Service pole, type ISSRM45F

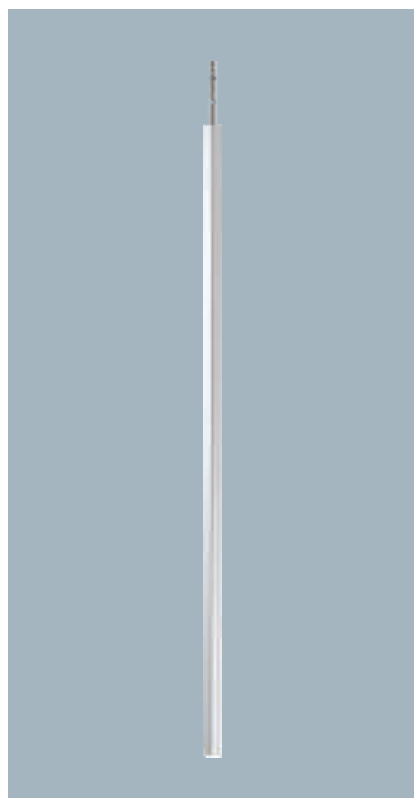

Type	Colour	Surface	Length mm	Pack Piece	Weight kg/100 pc.	Item no.
ISSRM45FRW	Pure white	—	2306	1	380.000	6290095
ISSRM45FEL	—	Anodised	2306	1	380.000	6290097

ISS aluminium service pole with a flexible hose to the ceiling and a 45 mm system opening.

Set consisting of:

1 one-compartment pole with flexible hose to ceiling

Total length: 2,300 mm

1 flexible hose, length: 1,500 mm

1 aluminium cover

Length: 2,300 mm

The design of this ISS service pole is based on an extremely slender, round aluminium profile, which has a smooth cover of the Rapid 45 device installation trunking series as its front side. The 45 mm system opening is suitable for direct acceptance of Modul 45® switching and connection devices.

The floor plate as a stand, type SFISSF, and the hose connection to the ceiling, type SAISSF, should be ordered separately (see articles below).

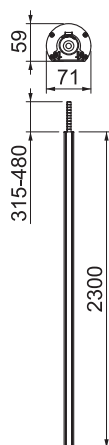

St

Floor plate for ISSRM45F

Type	Colour	Pack Piece	Weight kg/100 pc.	Item no.
SFISSFRW	Pure white	1	600.000	6290196
SFISSFWAL	White aluminium	1	600.000	6290197

Floor plate as stand for service poles with hose to ceiling, type ISS110100F, 140100F and ISSRM45F.

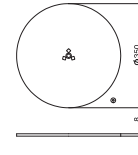

St

Hose connection for ISSRM45F

Type	Height mm	Pack Piece	Weight kg/100 pc.	Item no.
SAISSF	80	1	14.000	6290198

Hose connection as ceiling attachment for service poles with hose to ceiling, type ISS110100F and 140100F.

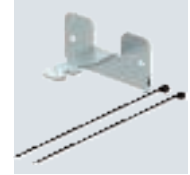
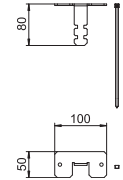

St

Ceiling panel for ISSRM45F

Type	Colour	Pack Piece	Weight kg/100 pc.	Item no.
DAB-F RW	Pure white	1	20.700	6290269

Ceiling rosette for tidy closure of the penetration of the flexible hose in the ceiling.

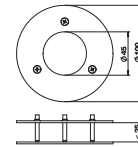

PVC

Partition for WDK trunking, trunking height 40 mm

Type	Colour	Length mm	Pack m	Weight kg/100 m	Item no.
2371 40	Light grey	2000	60	13.500	6023096

Partition to divide the WDK trunking, with 40 mm trunking height, and various ISS service poles for the installation of different voltage levels.

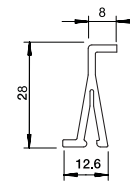

St

Floor plate for ISSRM45F

Type	Colour	Pack Piece	Weight kg/100 pc.	Item no.
SFISSFRW	Pure white	1	600.000	6290196
SFISSFWAL	White aluminium	1	600.000	6290197

Floor plate as stand for service poles with hose to ceiling, type ISS110100F, 140100F and ISSRM45F.

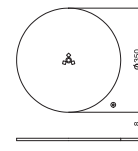

Hose connection for ISSRM45F

St

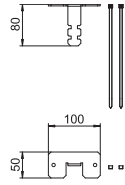
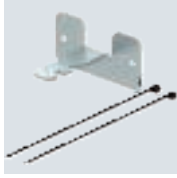

Type	Height mm	Pack Piece	Weight kg/100 pc.	Item no.
SAISSF	80	1	14.000	6290198

Hose connection as ceiling attachment for service poles with hose to ceiling, type ISS110100F and 140100F.

Ceiling panel for ISSRM45F

St

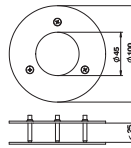

Type	Colour	Pack Piece	Weight kg/100 pc.	Item no.
DAB-F RW	Pure white	1	20.700	6290269

Ceiling rosette for tidy closure of the penetration of the flexible hose in the ceiling.

Alu EL

Service pole, type ISSDM45

Type	Colour	Surface	Length mm	Pack Piece	Weight kg/100 pc.	Item no.
ISSDM45EL	–	Anodised	3009	1	1,172.000	6289972
ISSDM45RW	Pure white	–	3009	1	1,172.000	6289970

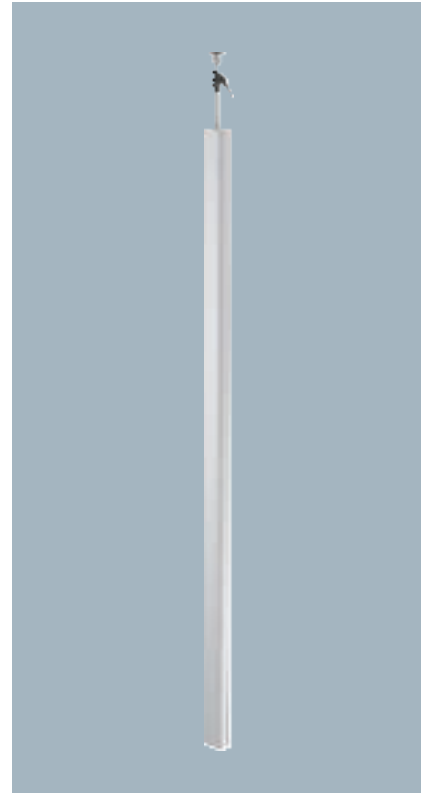

ISS aluminium service pole with a 45 mm system opening.

Set consisting of:

1 two-compartment pole with clamping fastening

Total length: 3,315–3,480 mm

1 ceiling attachment with clamp

2 aluminium covers, length 3,000 mm

The clamp which is attached to the top of the ISS service pole can be variably adjusted from 300 to 500 mm. Possible colour options are aluminium anodised or pure white. The pole is based on a slender, oval aluminium profile. There are two 45 mm system openings on opposite sides for direct installation of Module 45® devices.

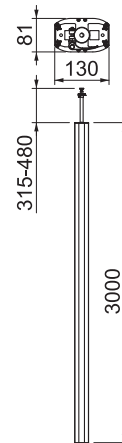

Rubber support for ISSDM45R

GUM

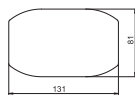

Type	Colour	Pack Piece	Weight kg/100 pc.	Item no.
ISSGUDM45	Black	1	4.600	6290372

Rubber support for slip-free fastening of the floor-ceiling service pole, type ISSDM45.

Ceiling panel for ISSDM45R

St

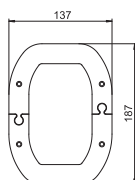

Type	Colour	Pack Piece	Weight kg/100 pc.	Item no.
WAGDM45	Pure white	1	46.800	6290387

Ceiling rosette for tidy closure of the pole penetration, type ISSDM45, in the ceiling.

Partition for WDK trunking, trunking height 40 mm

PVC

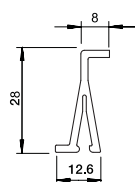

Type	Colour	Length mm	Pack m	Weight kg/100 m	Item no.
2371 40	Light grey	2000	60	13.500	6023096

Partition to divide the WDK trunking, with 40 mm trunking height, and various ISS service poles for the installation of different voltage levels.

Alu EL

Service pole, type ISSDM45F

Type	Colour	Surface	Length mm	Pack Piece	Weight kg/100 pc.	Item no.
ISSDM45FRW	Pure white	—	2306	1	871.000	6289974
ISSDM45FEL	—	Anodised	2306	1	871.000	6289976



ISS aluminium service pole with a 45 mm system opening.

Set consists of:

1 two-compartment pole with two flexible hoses to the ceiling

Total length of the aluminium profile: 2,300 mm
2 aluminium covers, length 2,300 mm

Colour options are pure white or aluminium anodised. There are two 45 mm system openings on opposite sides for direct installation of Module 45® devices. The floor plate as a stand, type SFISSF, and the hose connection to the ceiling, type SAISSF, should be ordered separately (see articles below).

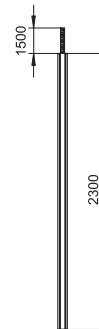
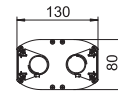

Floor-ceiling service poles, aluminium

Floor plate for ISSRM45F

St

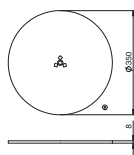

Type	Colour	Pack Piece	Weight kg/100 pc.	Item no.
SFISSFRW	Pure white	1	600.000	6290196
SFISSFWAL	White aluminium	1	600.000	6290197

Floor plate as stand for service poles with hose to ceiling, type ISS110100F, 140100F and ISSRM45F.

Hose connection for ISSRM45F

St

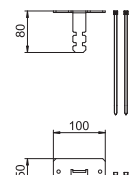
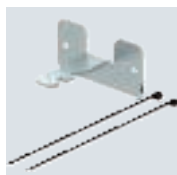

Type	Height mm	Pack Piece	Weight kg/100 pc.	Item no.
SAISSF	80	1	14.000	6290198

Hose connection as ceiling attachment for service poles with hose to ceiling, type ISS110100F and 140100F.

Ceiling panel for ISSDM45F

St

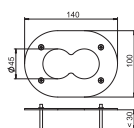

Type	Colour	Pack Piece	Weight kg/100 pc.	Item no.
DAB-2F	Pure white	1	27.100	6290382

Ceiling rosette for tidy closure of the penetration of the flexible hoses in the ceiling.

Partition for WDK trunking, trunking height 40 mm

PVC

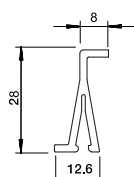

Type	Colour	Length mm	Pack m	Weight kg/100 m	Item no.
2371 40	Light grey	2000	60	13.500	6023096

Partition to divide the WDK trunking, with 40 mm trunking height, and various ISS service poles for the installation of different voltage levels.

Alu EL

Service pole, type 130130

Type	Colour	Surface	Length mm	Pack Piece	Weight kg/100 pc.	Item no.
ISS130130EL	—	Anodised	3013	1	100.000	6289405



Aluminium floor/ceiling service pole (surface anodised or powder-coated in RAL 9010) with two 76.5 mm system openings to accommodate accessory mounting boxes in the 71GD... series or for the installation of switching and connection devices.

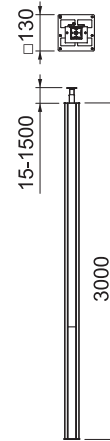

Service pole, type ISSHS4

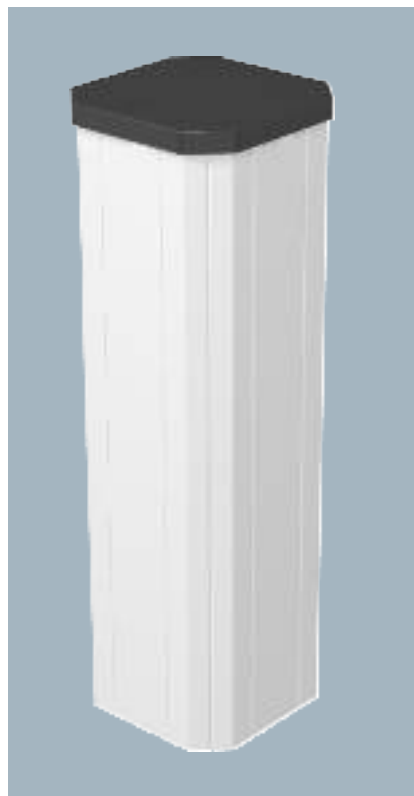

Type	Colour	Number of compartments pc.	Pack Piece	Weight kg/100 pc.	Item no.
ISSHS4 61OT3RW	Pure white	4	1	1,050.000	6286700
ISSHS4 61OT3LGR	Light grey	4	1	1,108.000	6286702

ISS sheet steel service pole with a 76.5 mm system opening on four sides. Empty, fittable from all four sides with six standard devices (socket, telephone, etc.) on each side, max. 24 devices. Fastening possible directly on the floor. Accessory mounting boxes to be ordered separately. The service pole is suitable for accepting front locking accessory mounting boxes of the series 71GD....

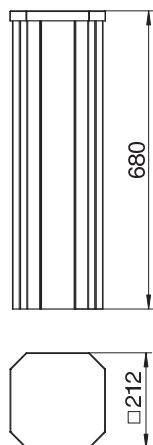

Protective frame for ISSHS4

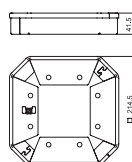

Type	Colour	Pack Piece	Weight kg/100 pc.	Item no.
ISSHS4SR40	Jet black	1	69.400	6286810

Protective frame for ISSHS4 service pole for mechanical protection of the columns in the foot area.

Alu EL

Service pole, type ISSHS140250

Type	Colour	Surface	Number of compartments pc.	Pack Piece	Weight kg/100 pc.	Item no.
ISSHS140250RW	Pure white	—	2	1	175.000	6290020
ISSHS140250EL	—	Anodised	2	1	175.000	6290023



ISS aluminium service pole, 2-compartment, with a 76.5 mm system opening.
 Empty, equippable with standard devices (socket, telephone, etc.), max. 4 devices.
 Direct fastening on floor possible. Accessory mounting boxes to be ordered separately.
 The service pole is suitable for accepting front locking accessory mounting boxes of the series 71GD.... The installation of a partition of type GA-TW (6279711) and the installation of the cover clip, type KL80A, are possible as an option.

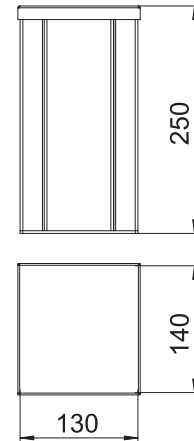

Service pole, type ISSHS140500

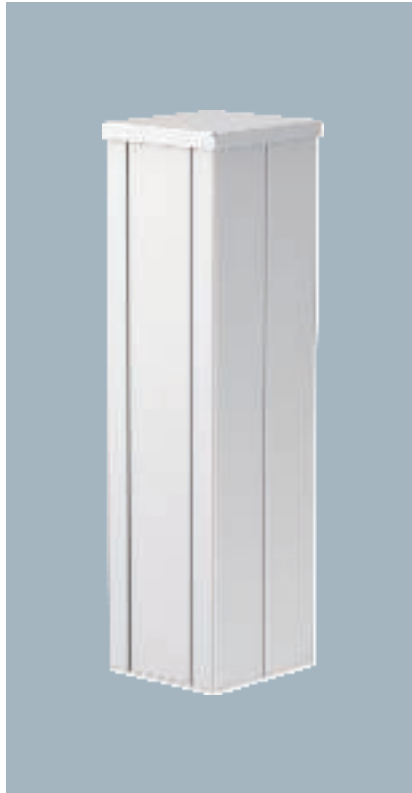

Type	Colour	Surface	Number of compartments pc.	Pack Piece	Weight kg/100 pc.	Item no.
ISSHS140500RW	Pure white	—	2	1	302.000	6290030
ISSHS140500EL	—	Anodised	2	1	354.800	6290033

ISS aluminium service pole, 2-compartment, with a 76.5 mm system opening.
 Empty, equippable with standard devices (socket, telephone, etc.), max. 8 devices.
 Direct fastening on floor possible. Accessory mounting boxes to be ordered separately.
 The service pole is suitable for accepting front locking accessory mounting boxes of the series 71GD.... The installation of a partition of type GA-TW (6279711) and the installation of the cover clip, type KL80A, are possible as an option.

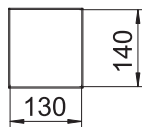
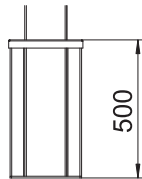

Alu EL

Service pole, type ISSHS140700

Type	Colour	Surface	Number of compartments pc.	Pack Piece	Weight kg/100 pc.	Item no.
ISSHS140700RW	Pure white	—	2	1	466.000	6290040
ISSHS140700EL	—	Anodised	2	1	466.000	6290043



ISS aluminium service pole, 2-compartment, with a 76.5 mm system opening. Empty, equippable with standard devices (socket, telephone, etc.), max. 10 devices. Direct fastening on floor possible. Accessory mounting boxes to be ordered separately. The service pole is suitable for accepting front locking accessory mounting boxes of the series 71GD.... The installation of a partition of type GA-TW (6279711) and the installation of the cover clip, type KL80A, are possible as an option.

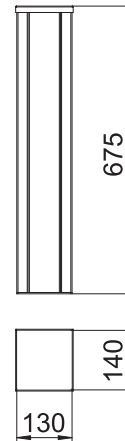

Service pole, type ISSHS6



Type	Colour	Surface	Number of compartments pc.	Pack Piece	Weight kg/100 pc.	Item no.
ISSHS6EL	—	Anodised	6	1	720.000	6290073

ISS service pole centre.

Empty, can be equipped from all four sides with standard devices (socket, telephone, etc.). Two sides of the installation centre can be equipped in two compartments, the other two sides in one. Each installation compartment can accept 5 devices, the entire installation centre accepts max. 30 devices. Direct fastening on floor possible. Accessory mounting boxes to be ordered separately.

The service pole is suitable for accepting front locking accessory mounting boxes of the series 71GD.... The installation of a partition of type GA-TW (6279711) and the installation of the cover clip, type KL80A, are possible as an option.

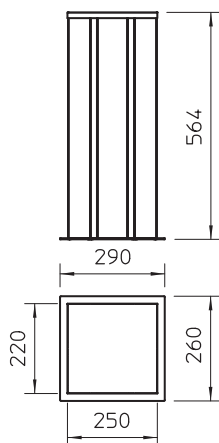

Alu EL

Service pole, type ISSRHSM45

Type	Colour	Surface	Number of compartments pc.	Pack Piece	Weight kg/100 pc.	Item no.
ISSRHSM45RW	Pure white	—	1	1	135.000	6290090
ISSRHSM45EL	—	Anodised	1	1	135.000	6290091

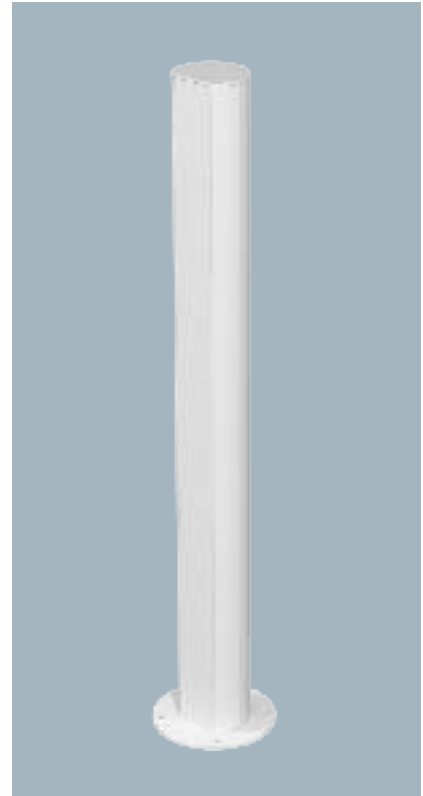

ISS aluminium service pole with a 45 mm system opening.

Set consists of:

1 one-compartment pole with stand

Total length: 675 mm

1 aluminium cover

Length: 670 mm

The design of this ISS service pole is based on an extremely slender, round aluminium profile, which has a smooth cover of the Rapid 45 device installation trunking series as its front side. The 45 mm system opening is suitable for direct acceptance of Modul 45® switching and connection devices. The installation compartment is theoretically sufficient for 14 Modul 45® devices. If Modul 45connect® is used or in the case of cabling requiring a lot of space, the number of the max. installable devices is reduced. There is the option to install a partition, type 2371/40 (6023096).

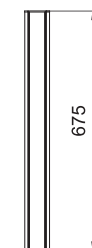
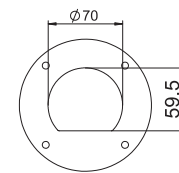

Service pole, type ISSDHSM45

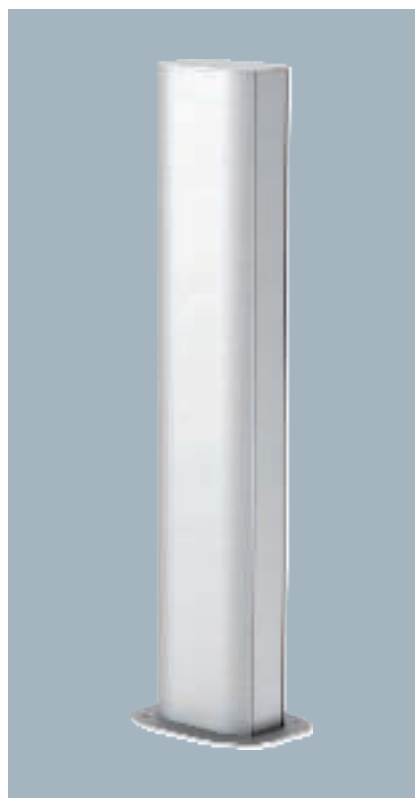

Type	Colour	Surface	Number of compartments pc.	Pack Piece	Weight kg/100 pc.	Item no.
ISSDHSM45RW	Pure white	—	2	1	281.500	6289980
ISSDHSM45EL	—	Anodised	2	1	281.500	6289982

ISS service pole made from aluminium with 45 mm system opening for the direct installation of Modul 45 switching and connection devices.

Pole consists of:

1 two-compartment pole with stand

Total length 675 mm

2 aluminium covers

Length 670 mm

The design of this service pole is based on an extremely narrow, oval aluminium profile which shows on both narrow sides of the oval a cover of the Rapid 45 device installation trunking series.

The 45 mm system opening is suitable for direct acceptance of Modul 45® switching and connection devices. The installation area is theoretically sufficient for 2 x 14 Modul 45® devices. If Modul 45connect® is used or in the case of cabling requiring a lot of space, the number of the max. installable devices is reduced. There is the option to install a partition, type 2371/40 (6023096).

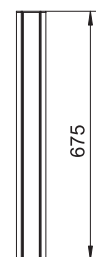
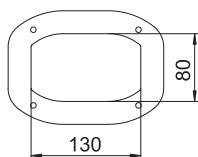



Accessory mounting box 71GD6, single

PA

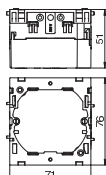

Colour		Pack	Weight	Item no.
Type	Piece	Piece	kg/100 pc.	
71GD6	Iron grey	5	5.600	6288610

Front locking accessory mounting box for switch systems, with folding, and also removable, base for time-saving cable connection, with feed openings for cable diameters of up to 14 mm. Halogen-free version.

Accessory mounting box 71GD7-2, double

PA

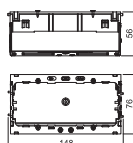
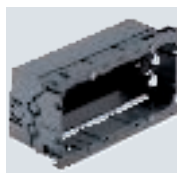

Colour		Pack	Weight	Item no.
Type	Piece	Piece	kg/100 pc.	
71GD7-2	Iron grey	2	8.200	6288608

Front locking accessory mounting box for standard switch ranges for the installation of two individual installation devices or a multiple protective contact socket. With unfolding, and also removable, base for time-saving cable connection and with feed openings for cable diameters of up to 14 mm. Halogen-free version.

Vertical fastening track 60 mm.

Accessory mounting box 71GD8-2, single, for Modul 45®

PA

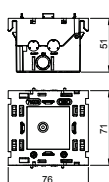

Colour		Pack	Weight	Item no.
Type	Piece	Piece	kg/100 pc.	
71GD8-2		1	5.900	6288569

Front locking single accessory mounting box for Modul 45® system, with folding, and also removable, base for time-saving cable connection, with feed openings for cable diameters of up to 14 mm.

Accessory mounting box 71GD13, double, for Modul 45®

PA

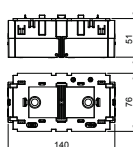

Colour		Pack	Weight	Item no.
Type	Piece	Piece	kg/100 pc.	
71GD13		1	11.000	6288583

Front locking double accessory mounting box for Modul 45® system, with folding, and also removable, base for time-saving cable connection, with feed openings for cable diameters of up to 14 mm.

Accessory mounting box 71GD9, triple, for Modul 45®

PA

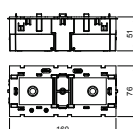

Colour		Pack	Weight	Item no.
Type	Piece	Piece	kg/100 pc.	
71GD9-2		1	11.600	6288579

Front locking triple accessory mounting box for Modul 45® system, with folding, and also removable, base for time-saving cable connection, with feed openings for cable diameters of up to 14 mm.

St G

Protective conductor connection bracket

Type	Surface	Pack Piece	Weight kg/100 pc.	Item no.
8AWR	Electrogalvanised	10	0.610	6288704

Protective conductor connection bracket to include steel and aluminium device installation trunking, service poles and system components of underfloor duct systems in the protective measure.
Clamping area: 2 x 1.5–4 mm²

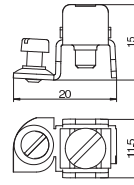

St

Locking bracket RKV3V

Type	Pack Piece	Weight kg/100 pc.	Item no.
RKV3V	20	0.085	6288700

Locking bracket for the mechanical and electrical connection of duct covers and duct bases. Suitable for covers of Rapid 45, Rapid 80 and ISS systems.



Connectable connection technology, Wieland GST18®, WAGO WINSTA®

Connectable connection technology, Wieland GST18®, WAGO WINSTA®



Connect WAGO WINSTA®

290



Sockets, Modul 45connect®

294



Adapter

Modul 45connect® connector part adapter

PA

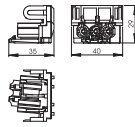

Type	Colour	Pack Piece	Weight kg/100 pc.	Item no.
STA-SKS SU1 SW	Black	10	1.190	6117196

Connector part adapter, U-shaped, for connection to an STD-D0C / STD-D3C or STD-F0C / STD-F3C socket from the side, for VL extension cable with Wieland connector GST 18i 3p.

Modul 45connect® connector part adapter

PA

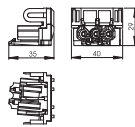

Type	Colour	Pack Piece	Weight kg/100 pc.	Item no.
STA-SKS SU1 W	White	10	1.190	6117197

Connector part adapter, U-shaped, for connection to an STD-D0C / STD-D3C or STD-F0C / STD-F3C socket from the side, for VL extension cable with Wieland connector GST 18i 3p.

Modul 45connect® connector

PA

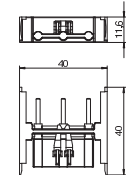

Type	Colour	Pack Piece	Weight kg/100 pc.	Item no.
VB-SKS S	Black	10	0.590	6117198

Connection adapter for combining STD-D0C / STD-D3C or STD-F0C / STD-F3C sockets.

Connection cables

3-wire connection cable, halogen-free, cross-section 2.5 mm², black

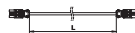

Type	Cable length mm	Cross-section mm ²	Number of poles	Colour	Pack Piece	Weight kg/100 pc.	Item no.
VL-3Q2.5 H1 SW	1000	2.5	3	Black	1	16.000	6108450
VL-3Q2.5 H3 SW	3000	2.5	3	Black	1	48.000	6108452
VL-3Q2.5 H5 SW	5000	2.5	3	Black	1	80.000	6108454
VL-3Q2.5 H8 SW	8000	2.5	3	Black	1	128.000	6108457
VL-3Q2.5 H10 SW	10000	2.5	3	Black	1	160.000	6108459

Halogen-free connection cables 3 x 2.5 mm² in the version socket – connector with GST18i connection system.

3-wire connection cable, PVC, cross-section 2.5 mm², black

Type	Cable length mm	Cross-section mm ²	Number of poles	Colour	Pack Piece	Weight kg/100 pc.	Item no.
VL-3Q2.5 1 SW	1000	2.5	3	Black	1	18.000	6108150
VL-3Q2.5 3 SW	3000	2.5	3	Black	1	54.000	6108152
VL-3Q2.5 5 SW	5000	2.5	3	Black	1	90.000	6108154
VL-3Q2.5 8 SW	8000	2.5	3	Black	1	144.000	6108157
VL-3Q2.5 10 SW	10000	2.5	3	Black	1	180.000	6108159

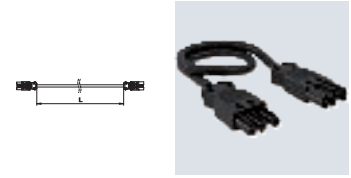

Connection cable 3 x 2.5 mm² in the version socket – connector with GST18i connection system.

3-wire connection cable, halogen-free, cross-section 2.5 mm², white

Type	Cable length mm	Cross-section mm ²	Number of poles	Colour	Pack Piece	Weight kg/100 pc.	Item no.
VL-3Q2.5 H3 W	3000	2.5	3	White	1	48.000	6108477
VL-3Q2.5 H5 W	5000	2.5	3	White	1	80.000	6108479
VL-3Q2.5 H8 W	8000	2.5	3	White	1	128.000	6108482
VL-3Q2.5 H10 W	10000	2.5	3	White	1	160.000	6108484

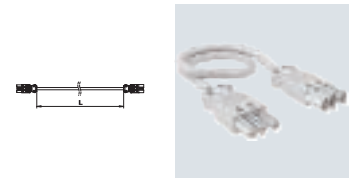

Halogen-free connection cables 3 x 2.5 mm² in the version socket – connector with GST18i connection system.

3-wire connection cable, PVC, cross-section 2.5 mm², white

Type	Cable length mm	Cross-section mm ²	Number of poles	Colour	Pack Piece	Weight kg/100 pc.	Item no.
VL-3Q2.5 1 W	1000	2.5	3	White	1	18.000	6108175
VL-3Q2.5 3 W	3000	2.5	3	White	1	54.000	6108177
VL-3Q2.5 5 W	5000	2.5	3	White	1	90.000	6108179
VL-3Q2.5 8 W	8000	2.5	3	White	1	144.000	6108182
VL-3Q2.5 10 W	10000	2.5	3	White	1	180.000	6108184

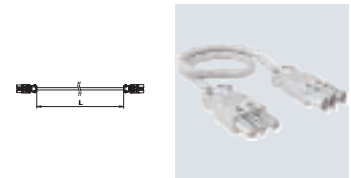

Connection cable 3 x 2.5 mm² in the version socket – connector with GST18i connection system.

Installation accessories for Connect Wieland GST18 ®

Connector part 3-pin, spring power connection

Type	Colour	Pack Piece	Weight kg/100 pc.	Item no.
ST-F GST18i3p SW	Black	1	2.600	6108050
ST-F GST18i3p W	White	1	2.620	6108051

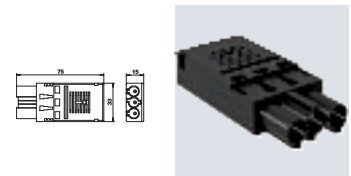

Connector part, 3-pin, type GST18i with spring power connection for rigid cables of 1.5–2.5 mm², single-wire and ultrasonically welded, fine wire cables 1.5 mm² with end sleeves, unmounted with strain relief, can be terminated in situ, 250 V, 16 A.

Two connections per pole, for cables H05VV, NYM (Ø 7.8–10.33 mm), lockable, a lock should be provided for strain relief according to VDE 0628.

Stripping length: 45 mm
Stripped length: 9 mm

Connector part, 3-pin, screw connection

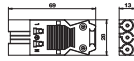

Type	Colour	Pack	Weight	Item no.
		Piece	kg/100 pc.	
ST-S GST18i3p SW	Black	1	2.030	6108054
ST-S GST18i3p W	White	1	2.030	6108055

Connector part, 3-pin, type GST18i with screw connection, low height (no slot loss in combination with distributor blocks), for cross-sections of 0.75–2.5 mm², single- and fine-wire cables connectable without end sleeve, for cable diameters between 6.5–10.5 mm (H05VV, NYM), unmounted with strain relief, terminable in situ, 250 V, 16 A.

Stripping length: 31 mm
Insulation removal length: 7 mm

Connector part, 3-pin, screw connection

PA

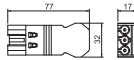

Type	Colour	Pack	Weight	Item no.
		Piece	kg/100 pc.	
ST-S4 GST18i3 SW	Black	1	1.600	6108060
ST-S4 GST18i3 W	White	1	1.600	6108062

Connector part, 3-pin, type GST18i with screw connection for cables of 1.5–4.0 mm² and cable diameters between 10.5–14.5 mm (H05VV, NYM), unmounted with strain relief, terminable in situ, 250 V, 16 A.

Connector part, 5-pin, screw connection



Type	Colour	Pack	Weight	Item no.
		Piece	kg/100 pc.	
ST-S GST18i5p SW	Black	1	4.330	6108070

Connector part, 5-pin, type GST18i, with screw connection for 1.5–2.5 mm² cables, single and fine-wire, with strain relief, one connection per pin, unmounted, for cables H05VV (Ø 9.5–13.5) NYM and (Ø 10.5–13.5 mm), lockable, according to the strain relief in VDE 0628 a lock should be planned, 250 V, 16 A.

Stripping length: 8 mm
Jacket removal length: 46 mm

Socket section 3-pin, spring power connection

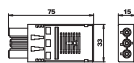

Type	Colour	Pack	Weight	Item no.
		Piece	kg/100 pc.	
BT-F GST18i3p SW	Black	1	2.620	6108052
BT-F GST18i3p W	White	1	2.690	6108053

Socket part, 3-pin, type GST18i with spring power connection for rigid cables of 1.5–2.5 mm², single-wire and ultra-sonically welded, fine wire cables 1.5 mm² with end sleeves, unmounted with strain relief, can be terminated in situ, 250 V, 16 A.

Two connections per pole, for cables H05VV, NYM (Ø 7.8–10.33 mm), lockable, a lock should be provided for strain relief according to VDE 0628.

Stripping length: 45 mm
Stripped length: 9 mm

Socket section 3-pin, screw connection

PA



Type	Colour	Pack	Weight	Item no.
		Piece	kg/100 pc.	
BT-S4 GST18i3 SW	Black	1	1.600	6108064
BT-S4 GST18i3 W	White	1	1.600	6108066

Socket section, 3-pin, type GST18i with screw connection for cables of 1.5–4.0 mm² and for cable diameters between 10.5–14.5 mm (H05VV, NYM), unmounted with strain relief, terminable in situ, 250 V, 16 A.

Socket section 3-pin, screw connection

Type	Colour	Pack Piece	Weight kg/100 pc.	Item no.
BT-S GST18i3p SW	Black	1	2.150	6108056
BT-S GST18i3p W	White	1	2.150	6108057

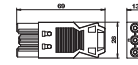

Socket part, 3-pin, type GST18i with screw connection, low height (no slot loss in combination with distributor blocks), for cross-sections of 0.75–2.5 mm², single- and fine-wire cables connectable without end sleeve, for cable diameters between 6.5–10.5 mm (H05VV, NYM), unmounted with strain relief, terminable in situ, 250 V, 16 A.

Stripping length: 31 mm
Insulation removal length: 7 mm

Socket section 5-pin, screw connection

Type	Colour	Pack Piece	Weight kg/100 pc.	Item no.
BT-S GST18i5p SW	Black	1	4.550	6108072

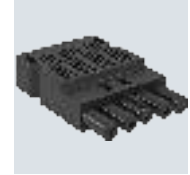
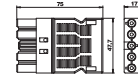

Socket part, 5-pin, type GST18i, with screw connection for 1.5 to 2.5 mm² cables, single and fine-wire, with strain relief, one connection per pin, unmounted, for cables H05VV (Ø 9.5 – 13.5) NYM and (Ø 10.5 to 13.5 mm), lockable, according to the strain relief in VDE 0628 a lock should be planned, 250 V, 16 A.

Stripping length: 8 mm
Jacket removal length: 46 mm

Distributor block 3-pin

Type	Colour	Pack Piece	Weight kg/100 pc.	Item no.
VB-3 GST18i3p	Black	1	3.590	6108080

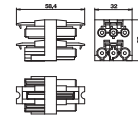

Distributor block with lock, type GST18i, one input with plug section 3-pin and three outputs with socket section 3-pin.

Distributor block 3-pin

Type	Colour	Pack Piece	Weight kg/100 pc.	Item no.
VB-5 GST18i3p	Black	1	5.590	6108082

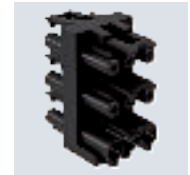
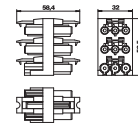

Distributor block with lock, type GST18i, one input with plug section 3-pin and five outputs with socket section 3-pin.

Distributor block, 3-pin, T-shaped

Type	Colour	Pack Piece	Weight kg/100 pc.	Item no.
VB-T GST18i3p	Black	1	2.540	6108084

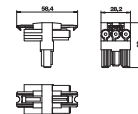

T distributor with lock, type GST18i, one input with 3-pin connector part and two outputs with 3-pin socket part.



PA

Distributor block, 3-pole

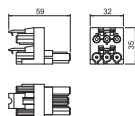

Type	Colour	Pack Piece	Weight kg/100 pc.	Item no.
VB-2 GST18i3p	Black	1	3.300	6108086

Distributor block with lock, type GST18i, 1 input with 3-pin plug section and 2 outputs with 3-pin socket section.

Surge protection module with support for Modul 45connect

5

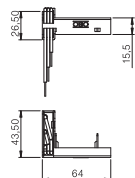

Type	Signalling on device	Pack Piece	Weight kg/100 pc.	Item no.
ÜSM-A-4T	Acoustic	1	2.226	6107801

2-pin surge protection module, 16 A/250 V~, with acoustic default display, no network switch-off, for connection to a multiple socket of type Modul 45connect using the supplied support. For installation in universal supports UT3/45 and UT4/45. The surge protection module meets EN 61643-11, type 3, Class III, requirements Class D.

Locking

PA

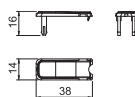

Type	Colour	Pack Piece	Weight kg/100 pc.	Item no.
VR-GST18	Black	10	0.100	6108074

Locking clip for GST18, plug connections, for locking connection cables.



3-wire connection cable, halogen-free, cross-section 2.5 mm², white

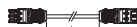

Type	Cable length mm	Colour	Pack Piece	Weight kg/100 pc.	Item no.
VL-WIN 3P2.5H1W	1000	White	1	16.500	6108732
VL-WIN 3P2.5H3W	3000	White	1	46.200	6108736
VL-WIN 3P2.5H5W	5000	White	1	78.370	6108740
VL-WIN 3P2.5H8W	8000	White	1	120.260	6108744

Connection cable 3 x 2.5 mm² in the version socket-connector, type WINSTA® MIDI.

Hose pipe: H05Z1Z1-F 3 x 2.5 mm²

3-wire connection cable, halogen-free, cross-section 2.5 mm², black

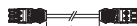

Type	Cable length mm	Colour	Pack Piece	Weight kg/100 pc.	Item no.
VL-WIN 3P2.5H1SW	1000	Black	1	16.500	6108730
VL-WIN 3P2.5H3SW	3000	Black	1	46.200	6108734
VL-WIN 3P2.5H5SW	5000	Black	1	78.000	6108738
VL-WIN 3P2.5H8SW	8000	Black	1	120.280	6108742

Connection cable 3 x 2.5 mm² in the version socket-connector, type WINSTA® MIDI.

Hose pipe: H05Z1Z1-F 3 x 2.5 mm²

3-wire connection cable, PVC, cross-section 2.5 mm², white

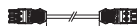

Type	Cable length mm	Colour	Pack Piece	Weight kg/100 pc.	Item no.
VL-WIN 3P2.5 1W	1000	White	1	17.820	6108712
VL-WIN 3P2.5 3W	3000	White	1	49.880	6108716
VL-WIN 3P2.5 5W	5000	White	1	82.000	6108720
VL-WIN 3P2.5 8W	8000	White	1	127.570	6108724

Connection cable 3 x 2.5 mm² in the version socket-connector, type WINSTA® MIDI.

PVC hose pipe: H05VV-F 3 x 2.5 mm²

3-wire connection cable, PVC, cross-section 2.5 mm², black

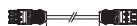

Type	Cable length mm	Colour	Pack Piece	Weight kg/100 pc.	Item no.
VL-WIN 3P2.5 1SW	1000	Black	1	17.820	6108710
VL-WIN 3P2.5 3SW	3000	Black	1	46.800	6108714
VL-WIN 3P2.5 5SW	5000	Black	1	82.000	6108718
VL-WIN 3P2.5 8SW	8000	Black	1	130.170	6108722

Connection cable 3 x 2.5 mm² in the version socket-connector, type WINSTA® MIDI.

PVC hose pipe: H05VV-F 3 x 2.5 mm²



PA

Connector part 3-pin

Type	Colour	Pack Piece	Weight kg/100 pc.	Item no.
ST-WIN 3P SW	Black	1	2.000	6108954
ST-WIN 3P W	White	1	1.999	6108956

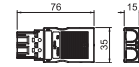

Connector 3-pin, type WINSTA® MIDI with clamp connection.

PA

Connector part, 5-pin

Type	Colour	Pack Piece	Weight kg/100 pc.	Item no.
ST-WIN 5P SW	Black	1	2.970	6108964
ST-WIN 5P W	White	1	2.948	6108966

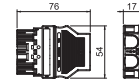

Connector 5-pin, type WINSTA® MIDI with clamp connection.

PA

Socket section 3-pin

Type	Colour	Pack Piece	Weight kg/100 pc.	Item no.
BT-WIN 3P SW	Black	1	2.000	6108950
BT-WIN 3P W	White	1	1.965	6108952

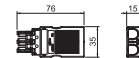

Socket section 3-pin, type WINSTA® MIDI with clamp connection.

PA

Socket section 5-pin

Type	Colour	Pack Piece	Weight kg/100 pc.	Item no.
BT-WIN 5P SW	Black	1	2.904	6108960
BT-WIN 5P W	White	1	2.885	6108962

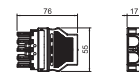

Socket section 5-pin, type WINSTA® MIDI with clamp connection.

PA

Distributor block, 3-pole, 1/20

Type	Colour	Pack Piece	Weight kg/100 pc.	Item no.
VB2-WIN 3P	Black	1	2.283	6108970

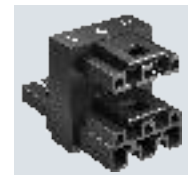
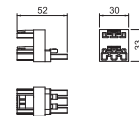

2x distributor, 3-pin, type WINSTA® MIDI.

Distributor block 3-pin, 1E/3A



Type	Colour	Pack	Weight	Item no.
		Piece	kg/100 pc.	
VB3-WIN 3P	Black	1	2.510	6108972
VB5-WIN 3P	White	1	3.700	6108974

3x distributor, 3-pin, type WINSTA® MIDI.

Locking lever for WINSTA® MIDI.

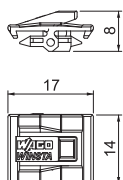

Type	Colour	Pack	Weight	Item no.
		Piece	kg/100 pc.	
VK-WIN	Black	25	0.056	6108700

Locking lever for plug connector system WINSTA® MIDI.





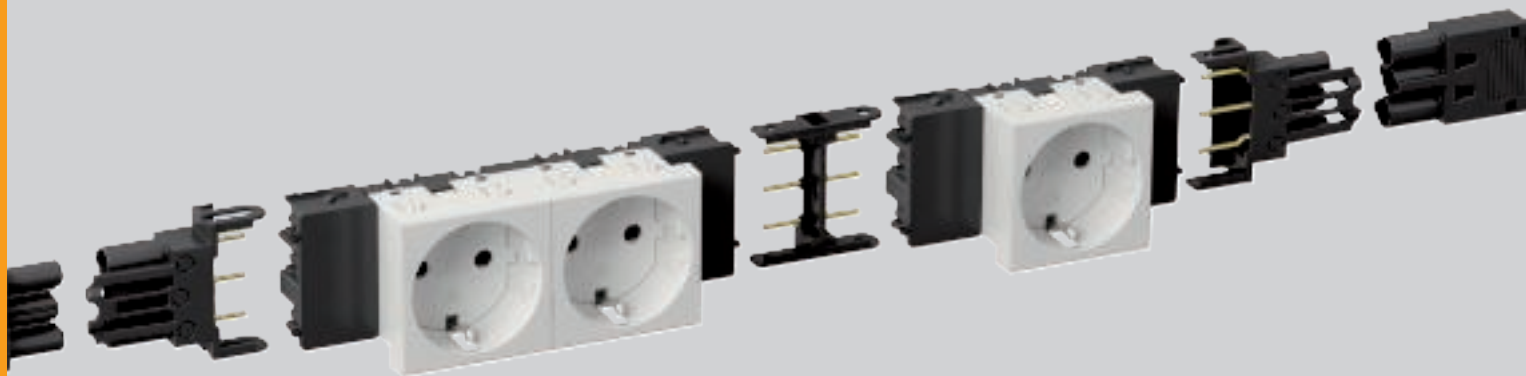

Modul 45connect®

Plug-in installation solutions for device installation trunking and service poles

As continuously connectable installation technology, the Modul 45connect® range for device installation trunking and service poles offers the highest level of flexibility, security and cost-efficiency.

From energy distribution through to device connection in the trunking, the system offers all the required installation components.



Fast installation without the need for tools, using Modul 45connect®



Safe installation through encoded connection technology



Direct mounting in the trunking – without additional components

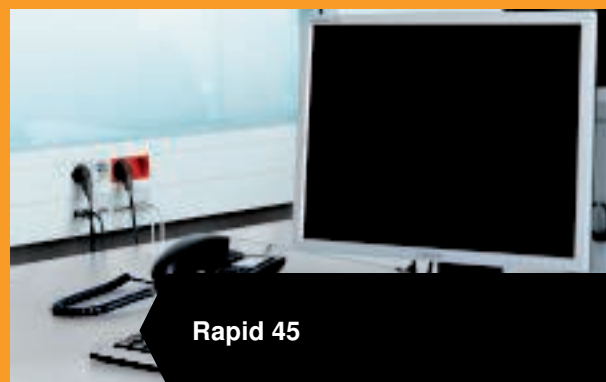

Rapid 45



Rapid 80

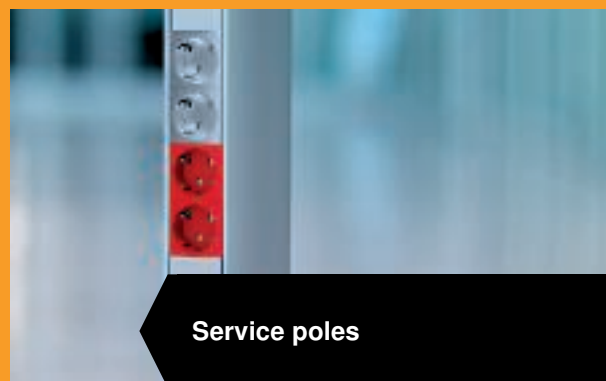

Service poles











Sockets, switches, data and multimedia technology



Sockets, switches, data and multimedia technology

	Sockets	298
	Accessories, sockets	310
	Switch	312
	Data technology support	316
	Data technology modules	322
	Multimedia technology	326





Modul 45[®] Devices

With their dimensions of 45 x 45 mm, the Modul 45[®] devices from OBO Bettermann are compact and space-saving. For this reason, the sockets, data and multimedia technology connections are ideal for use in underfloor systems, device installation trunking and service poles. The Modul 45[®] system makes optimum use of limited installation space.

The advantages of Modul 45[®] at a glance:

- Space savings thanks to compact design
- Modular structure
- Quick and easy planning
- Simple mounting
- High efficiency due to time and cost savings
- Wide range of application options
- Easy exchangeability



Installation in floor boxes



Installation in
device installation trunking



Installation in
service poles

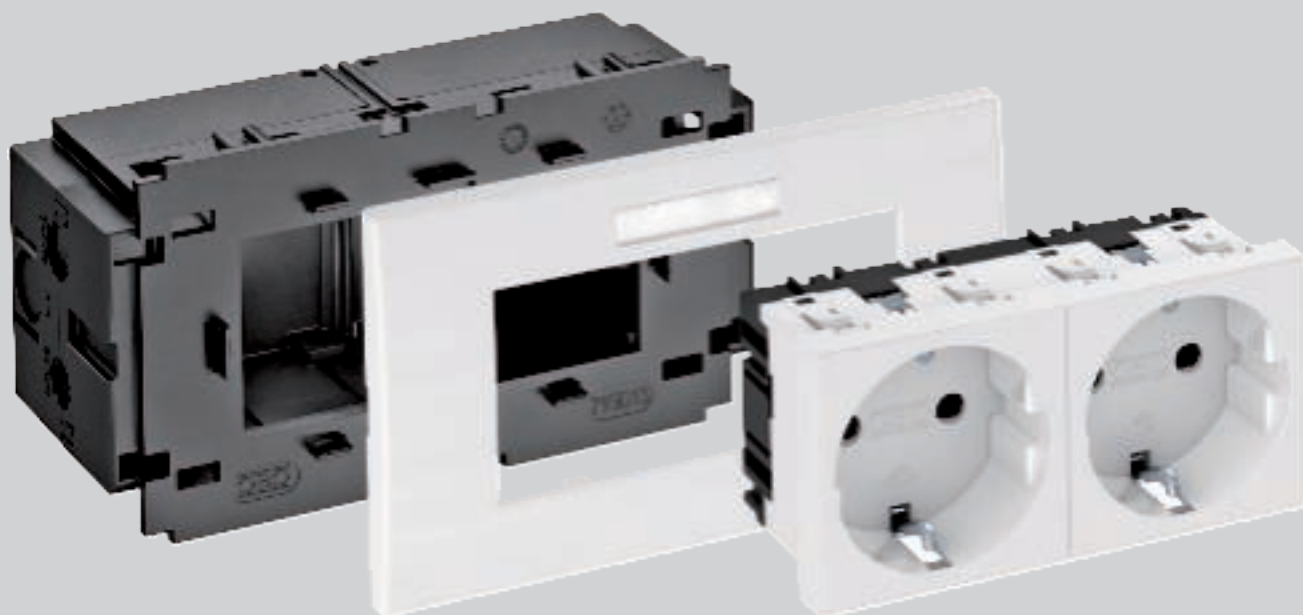

Modul 45® and standard

Installation solutions for device installation trunking and service poles with 80 mm system opening

The Modul 45® devices from OBO Bettermann are compact and space-saving. They are therefore ideal for use in device installation trunking and service poles. The Modul 45® system makes optimum use of limited installation space.

The advantages of Modul 45® at a glance:

- Space savings thanks to compact design
- Modular structure
- Quick and easy planning
- Simple mounting
- High efficiency due to time and cost savings
- Wide range of application options
- Easy exchangeability



Rapid 45

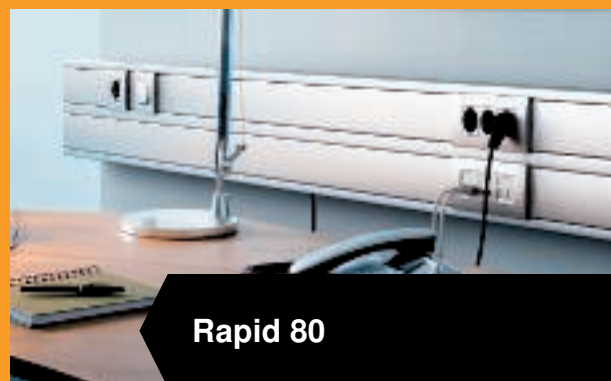



Rapid 80



Service poles

With protective contact

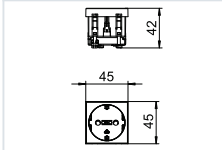
0° socket, protective contact, single





Type	STD-D0 RW1	STD-D0 ROR1	STD-D0 MZGN1	STD-D0 SRO1	STD-D0 SWGR1	STD-D0 AL1
Colour	Pure white	Pure orange	Mint green	Signal red	Black-grey	Aluminium-painted
Pack Piece	1	1	1	1	1	1
Weight kg/100 pc.	4.200	4.200	4.200	4.200	4.200	4.200
Item no.	6120008	6120010	6120012	6120014	6120016	6120018

PC Polycarbonate

Power socket, single 0°, with increased touch protection with screwless terminals, 2-pin, 16 A, 250 V~, with connection terminals to IEC 60884-1.

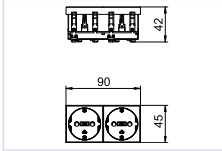
0° socket, protective contact, double





Type	STD-D0 RW2	STD-D0 ROR2	STD-D0 MZGN2	STD-D0 SRO2	STD-D0 SWGR2	STD-D0 AL2
Colour	Pure white	Pure orange	Mint green	Signal red	Black-grey	Aluminium-painted
Pack Piece	1	1	1	1	1	1
Weight kg/100 pc.	8.000	8.000	8.000	8.000	8.000	8.000
Item no.	6120022	6120024	6120026	6120028	6120030	6120032

PC Polycarbonate

Power socket, double 0°, with increased touch protection with screwless terminals, 2-pin, 16 A, 250 V~, with connection terminals to IEC 60884-1.

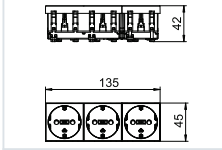
0° socket, protective contact, triple

Type	STD-D0 RW3	STD-D0 ROR3	STD-D0 MZGN3	STD-D0 SRO3	STD-D0 SWGR3	STD-D0 AL3
Colour	Pure white	Pure orange	Mint green	Signal red	Black-grey	Aluminium-painted
Pack Piece	1	1	1	1	1	1
Weight kg/100 pc.	12.200	12.200	12.200	12.200	12.200	12.200
Item no.	6120042	6120044	6120046	6120048	6120050	6120052

PC Polycarbonate

Power socket, triple 0°, with increased touch protection with screwless terminals, 2-pin, 16 A, 250 V~, with connection terminals to IEC 60884-1.

0° socket, protective contact, encoded version, single



Type	STD-D0K SRO1
Colour	Signal red
Pack Piece	1
Weight kg/100 pc.	4.200
Item no.	6120292

PC Polycarbonate

Protective contact socket Single 0°, encoded version, with increased touch protection, with screwless terminals, 2-pin, 16 A, 250 V~, with connection terminals according to IEC 60884-1.
The socket can only be used in connection with an encoding pin of type CST-STD.

Note: The encoding pin is not contained in the scope of supply.

0° socket, protective contact, encoded version, double



Type	STD-D0K SRO2
Colour	Signal red
Pack Piece	1
Weight kg/100 pc.	8.000
Item no.	6120294

PC Polycarbonate

Protective contact socket Double 0°, encoded version, with increased touch protection, with screwless terminals, 2-pin, 16 A, 250 V~, with connection terminals according to IEC 60884-1.
The socket can only be used in connection with an encoding pin of type CST-STD.

Note: The encoding pin is not contained in the scope of supply.

0° socket, protective contact, encoded version, triple



Type	STD-D0K SRO3
Colour	Signal red
Pack Piece	1
Weight kg/100 pc.	12.200
Item no.	6120296

PC Polycarbonate

Protective contact socket Triple 0°, encoded version, with increased touch protection, with screwless terminals, 2-pin, 16 A, 250 V~, with connection terminals according to IEC 60884-1.
The socket can only be used in connection with an encoding pin of type CST-STD.

Note: The encoding pin is not contained in the scope of supply.

33° socket, protective contact, single

	Type	STD-D3S RW1	STD-D3S ROR1	STD-D3S MZGN1	STD-D3S SRO1	STD-D3S SWGR1
Colour	Pure white	Pure orange	Mint green	Signal red	Black-grey	Aluminium-painted
Pack Piece	1	1	1	1	1	1
Weight kg/100 pc.	4.000	4.000	4.000	4.000	4.000	4.000
Item no.	6120073	6120075	6120077	6120079	6120081	6120083

PC Polycarbonate

Protective contact socket single 33°, with increased touch protection, with screwless terminals, 2-pin, 16 A, 250 V~, with connection terminals to IEC 60884-1.

Protective contact socket, 33°, double

	Type	STD-D3S RW2	STD-D3S ROR2	STD-D3S MZGN2	STD-D3S SRO2	STD-D3S SWGR2
Colour	Pure white	Pure orange	Mint green	Signal red	Black-grey	Aluminium-painted
Pack Piece	1	1	1	1	1	1
Weight kg/100 pc.	7.700	7.700	7.700	7.700	7.700	7.700
Item no.	6120103	6120105	6120107	6120109	6120111	6120114

PC Polycarbonate

Protective contact socket double 33°, with increased touch protection, with screwless terminals, 2-pin, 16 A, 250 V~, with connection terminals to IEC 60884-1.



33° socket, protective contact, triple

	Type	STD-D3S RW3	STD-D3S ROR3	STD-D3S MZGN3	STD-D3S SRO3	STD-D3S SWGR3
Colour	Pure white	Pure orange	Mint green	Signal red	Black-grey	Aluminium-painted
Pack Piece	1	1	1	1	1	1
Weight kg/100 pc.	11.000	11.000	11.000	11.000	11.000	11.000
Item no.	6120123	6120125	6120127	6120129	6120131	6120133

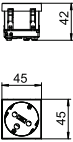

PC Polycarbonate

Protective contact socket triple 33°, with increased touch protection, with screwless terminals, 2-pin, 16 A, 250 V~, with connection terminals to IEC 60884-1.

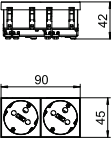

Socket 33°, protective contact, encoded version

	
Type	STD-D3K SRO1
Colour	Signal red
Pack Piece	1
Weight kg/100 pc.	4.000
Item no.	6120302
	PC Polycarbonate
<p>Protective contact socket Single 33°, encoded version, with increased touch protection, with screwless terminals, 2-pin, 16 A, 250 V~, with connection terminals according to IEC 60884-1. The socket can only be used in connection with an encoding pin of type CST-STD.</p> <p>Note: The encoding pin is not contained in the scope of supply.</p>	

33° socket, protective contact, encoded version, double

	
Type	STD-D3K SRO2
Colour	Signal red
Pack Piece	1
Weight kg/100 pc.	7.700
Item no.	6120304
	PC Polycarbonate
<p>Protective contact socket Double 33°, encoded version, with increased touch protection, with screwless terminals, 2-pin, 16 A, 250 V~, with connection terminals according to IEC 60884-1. The socket can only be used in connection with an encoding pin of type CST-STD.</p> <p>Note: The encoding pin is not contained in the scope of supply.</p>	

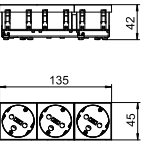
33° socket, protective contact, encoded version, triple

	
Type	STD-D3K SRO3
Colour	Signal red
Pack Piece	1
Weight kg/100 pc.	11.000
Item no.	6120306
	PC Polycarbonate
<p>Protective contact socket Triple 33°, encoded version, with increased touch protection, with screwless terminals, 2-pin, 16 A, 250 V~, with connection terminals according to IEC 60884-1. The socket can only be used in connection with an encoding pin of type CST-STD.</p> <p>Note: The encoding pin is not contained in the scope of supply.</p>	

Preterminated socket units

AR45 socket unit, single

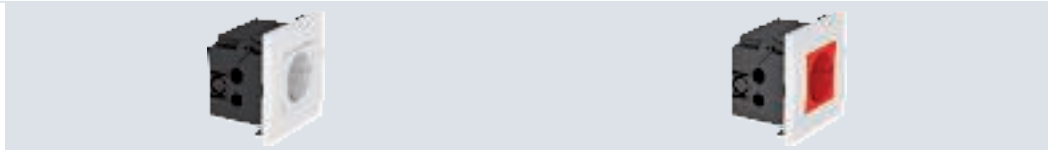
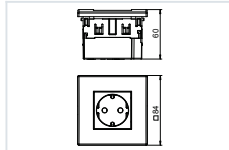

Type	SDE-RW D0RW1	SDE-RW D0RT1
Colour	Pure white	Signal red
Pack Piece	4	4
Weight kg/100 pc.	10.700	10.700
Item no.	6119401	6119403

PC Polycarbonate

Pre-terminated socket unit without labelling panel, suitable for installation in Rapid 80 device installation trunking systems.

Socket unit, consisting of:

- Accessory mounting box, single, type 71GD8-2.
- Protective contact socket, single, 0° connection direction, colour: see table.
- Cover frame AR45, single, without labelling panel, colour: pure white

AR45 socket unit, double

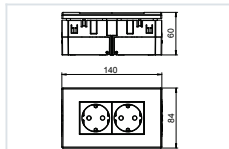

Type	SDE-RW D0RW2	SDE-RW D0RT2
Colour	Pure white	Signal red
Pack Piece	2	2
Weight kg/100 pc.	19.000	19.000
Item no.	6119407	6119409

PC Polycarbonate

Pre-terminated socket unit without labelling panel, suitable for installation in Rapid 80 device installation trunking systems.

Socket unit, consisting of:

- Service outlet, double, type 71GD13
- Protective contact socket, double, 0° connection direction, colour: see table
- Cover frame AR45, double, without labelling panel, colour: pure white

AR45 socket unit, triple

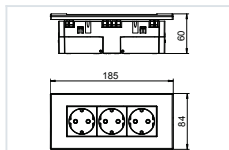

Type	SDE-RW D0RW3	SDE-RW D0RT3
Colour	Pure white	Signal red
Pack Piece	2	2
Weight kg/100 pc.	23.300	23.300
Item no.	6119414	6119413



PC Polycarbonate

Pre-terminated socket unit without labelling panel, suitable for installation in Rapid 80 device installation trunking systems.

Socket unit, consisting of:

- Service outlet, triple, type 71GD9-2
- Protective contact socket, triple, 0° connection direction, colour: see table
- Cover frame AR45, triple, without labelling panel, colour: pure white

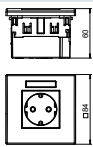
AR45 socket unit, single, with labelling panel for horizontal device installation

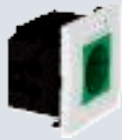
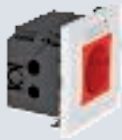
			
Type	SDE-RW D0RW1B	SDE-RW D0GN1B	SDE-RW D0RT1B
Colour	Pure white	Mint green	Signal red
Pack Piece	4	4	4
Weight kg/100 pc.	10.700	10.700	10.700
Item no.	6119421	6119422	6119423
	PC Polycarbonate		

Pre-terminated socket unit with labelling panel, suitable for installation in Rapid 80 device installation trunking systems.

Socket unit, consisting of:

- Accessory mounting box, single, type 71GD8-2
- Protective contact socket, single, 0° connection direction, colour: see table
- Cover frame AR45, single, with labelling panel, type AR45-BF..., colour: pure white

AR45 socket unit, double, with labelling panel for horizontal device installation



		
Type	SDE-RW D0RW2B	SDE-RW D0RT2B
Colour	Pure white	Signal red
Pack Piece	2	2
Weight kg/100 pc.	19.000	19.000
Item no.	6119427	6119429
	PC Polycarbonate	

Pre-terminated socket unit with labelling panel, suitable for installation in Rapid 80 device installation trunking systems.

Socket unit, consisting of:

- Accessory mounting box, double, type 71GD13
- Protective contact socket, double, 0° connection direction, colour: see table
- Cover frame AR45, double, with labelling panel, type AR45-BF..., colour: pure white

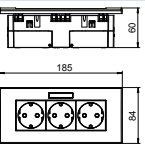
AR45 socket unit, triple, with labelling panel for horizontal device installation

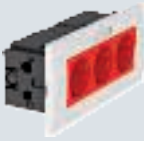
		
Type	SDE-RW D0RW3B	SDE-RW D0RT3B
Colour	Pure white	Signal red
Pack Piece	2	2
Weight kg/100 pc.	23.300	23.300
Item no.	6119433	6119435
	PC Polycarbonate	

Pre-terminated socket unit with labelling panel, suitable for installation in Rapid 80 device installation trunking systems.

Socket unit, consisting of:

- Accessory mounting box, triple, type 71GD9-2
- Protective contact socket, triple, 0° connection direction, colour: see table
- Cover frame AR45, triple, with labelling panel, type AR45-BF..., colour: pure white

Preterminated socket units

CEE socket unit, single, 16 A

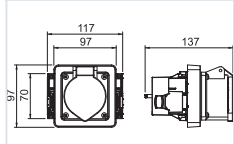

Type **71GDCEE16**

Colour Graphite black

Pack Piece 1

Weight kg/100 pc. 31.100

Item no. **6119483**

PA Polyamide

Accessory mounting box for the installation of a 3 or 5-pole CEE socket, 16 A or 32 A.

Scope of delivery:

- 1 front-locking accessory mounting box for 4-point fastening track of 52 x 52 mm to 70 x 70 mm
- 1 cover frame in pure white for hiding the fastening technology
- 2 external strain reliefs for jacketed cables of up to Ø 18 mm
- 2 sash locks for optional fastening to trunking bases with C rail
- 1 CEE socket 16 A with mounting accessories

CEE socket unit, single, 32 A

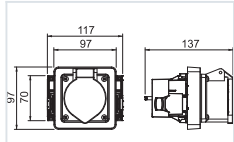

Type **71GDCEE32**

Colour Graphite black

Pack Piece 1

Weight kg/100 pc. 37.200

Item no. **6119485**

PA Polyamide

Accessory mounting box for the installation of a 3 or 5-pole CEE socket, 16 A or 32 A.

Scope of delivery:

- 1 front-locking accessory mounting box for 4-point fastening track of 52 x 52 mm to 70 x 70 mm
- 1 cover frame in pure white for hiding the fastening technology
- 2 external strain reliefs for jacketed cables of up to Ø 18 mm
- 2 sash locks for optional fastening to trunking bases with C rail
- 1 CEE socket 32 A with mounting accessories

Installation unit AR45, for 2 PU

PC

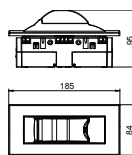

Type	Colour	Pack Piece	Weight kg/100 pc.	Item no.
IKR-6 RW	Pure white	1	19.000	6119319

Installation unit to accept protective units such as miniature circuit breakers or FI protection switches up to max. 2 PUs, suitable for installation in Rapid 80 device installation trunking systems and ISS service poles.

Installation unit, consisting of:

- Accessory mounting box, triple, type 71GD9-2
- Cover, incl. PVC support clamp for 2 PUs, colour: see table
- Cover frame AR45, triple, without labelling panel, colour: pure white

PA

Accessory mounting box 71GD6, single

Type	Colour	Pack Piece	Weight kg/100 pc.	Item no.
71GD6	Iron grey	5	5.600	6288610

Front locking accessory mounting box for switch systems, with folding, and also removable, base for time-saving cable connection, with feed openings for cable diameters of up to 14 mm. Halogen-free version.

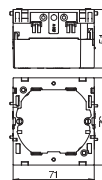

PA



Accessory mounting box 71GD7-2, double

Type	Colour	Pack Piece	Weight kg/100 pc.	Item no.
71GD7-2	Iron grey	2	8.200	6288608

Front locking accessory mounting box for standard switch ranges for the installation of two individual installation devices or a multiple protective contact socket. With unfolding, and also removable, base for time-saving cable connection and with feed openings for cable diameters of up to 14 mm. Halogen-free version.

Vertical fastening track 60 mm.

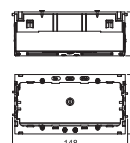

PA

Accessory mounting box 71GD8-2, single, for Modul 45®

Type	Pack Piece	Weight kg/100 pc.	Item no.
71GD8-2	1	5.900	6288569

Front locking single accessory mounting box for Modul 45® system, with folding, and also removable, base for time-saving cable connection, with feed openings for cable diameters of up to 14 mm.

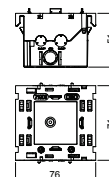

PA

Accessory mounting box 71GD13, double, for Modul 45®

Type	Pack Piece	Weight kg/100 pc.	Item no.
71GD13	1	11.000	6288583

Front locking double accessory mounting box for Modul 45® system, with folding, and also removable, base for time-saving cable connection, with feed openings for cable diameters of up to 14 mm.

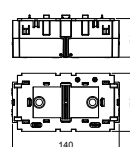

PA

Accessory mounting box 71GD9, triple, for Modul 45®

Type	Pack Piece	Weight kg/100 pc.	Item no.
71GD9-2	1	11.600	6288579

Front locking triple accessory mounting box for Modul 45® system, with folding, and also removable, base for time-saving cable connection, with feed openings for cable diameters of up to 14 mm.

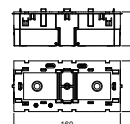

7ZE strain relief

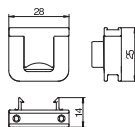

Type	Pack Piece	Weight kg/100 pc.	Item no.
7ZE	50	0.700	6288790

Strain relief with locking clips, suitable for the accessory mounting boxes 7GD... and 71GD...
Cable clamping range to 14 mm.

Modul 45®, cover frame

Cover frame AR45-F1, for accessory mounting box 71GD8-2, single

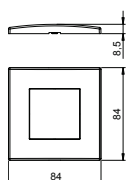

Type	Colour	Pack Piece	Weight kg/100 pc.	Item no.
AR45-F1 RW	Pure white	1	1.600	6119322
AR45-F1 SWGR	Black-grey	1	1.600	6119324
AR45-F1 AL	Aluminium-painted	1	1.600	6119326

Front locking cover frame for Modul 45 devices, single, without labelling panel for horizontal and vertical device installation, for locking in accessory mounting box 71GD8-2.

Cover frame AR45-F2, for accessory mounting box 71GD13, double

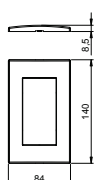

Type	Colour	Pack Piece	Weight kg/100 pc.	Item no.
AR45-F2 RW	Pure white	1	2.320	6119342
AR45-F2 SWGR	Black-grey	1	2.320	6119344
AR45-F2 AL	Aluminium-painted	1	2.320	6119346

Front locking cover frame for Modul 45 devices, single, without labelling panel for horizontal and vertical device installation, for locking in accessory mounting box 71GD13 or in mounting support 71MT2 45.

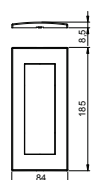

Cover frame AR45-F3, for accessory mounting box 71GD9-2, triple



Type	Colour	Pack Piece	Weight kg/100 pc.	Item no.
AR45-F3 RW	Pure white	1	2.800	6119372
AR45-F3 SWGR	Black-grey	1	2.800	6119374
AR45-F3 AL	Aluminium-painted	1	2.800	6119376

Front locking cover frame for Modul 45 devices, triple, without labelling panel for horizontal and vertical device installation, for locking in accessory mounting box 71GD9-2 or in mounting support 71MT3 45-2.

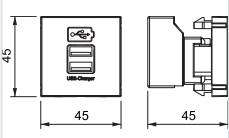
USB charging device

			
	Type	MTG-2UC2.1 RW1	MTG-2UC2.1 SWGR1
Colour	Pure white	Black-grey	Aluminium-painted
Pack Piece	1	1	1
Weight kg/100 pc.	6.162	5.500	5.500
Item no.	6105300	6105302	6105304
PC Polycarbonate			
USB charging device with two USB type A sockets, for charging 1–2 mobile devices, maximum charging current 1x 2,100 mA or 2x 1,050 mA.			

Equipotential bonding socket

Equipotential bonding socket, 1 module, straight outlet

			
	Type	PAD-ID6 RW1	PAD-ID6 SWGR1
Colour	Pure white	Black-grey	Aluminium-painted
Pack Piece	1	1	1
Weight kg/100 pc.	5.000	5.000	5.000
Item no.	6120003	6120001	6120005
PC Polycarbonate			
Equipotential bonding socket to DIN 42801, socket in black with green-yellow colour ring, cable connection to rear with M6 screw bolt, including two nuts, washers and a serrated washer.			

Strain reliefs

Strain relief for Modul 45® sockets 0°

PC

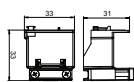

Type	Colour	Pack	Weight	Item no.
		Piece	kg/100 pc.	
ZL-STD 0	Black	1	1.800	6120782

Strain relief for Modul 45 sockets, type STD, connectable at side, for the fastening of a 3-core cable, max. Ø 10 mm, suitable for protective contact sockets at direction of insertion 0° and sockets with earthing pin at direction of insertion 0°.

Encoding pin

PC

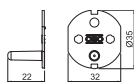

Type	Colour	Pack	Weight	Item no.
		Piece	kg/100 pc.	
CST-STD K	Black-grey	10	0.200	6120797

Encoding pin as socket attachment for the use of encoded sockets, type STD.

Cable outlet

PC

Cable outlet for 3–11 mm cross-section

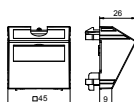

Type	Colour	Pack	Weight	Item no.
		Piece	kg/100 pc.	
KAL-K11 RW1	Pure white	1	3.500	6117420
KAL-K11 SWGR1	Black-grey	1	3.500	6117421
KAL-K11 AL1	Aluminium-painted	1	3.500	6117422

Two-part cable outlet with labelling panel, consisting of a cable support with strain relief and a cover. The strain relief is suited for cable cross-sections of 3 to 11 mm. The locking fastening is suitable for horizontal and vertical installation in the system environment.

Blanking covers

PC

Blanking cover with labelling panel, 1/2 module

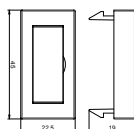

Type	Colour	Pack	Weight	Item no.
		Piece	kg/100 pc.	
ADP-BF RW0.5	Pure white	1	0.400	6117410
ADP-BF SWGR0.5	Black-grey	1	0.400	6117411
ADP-BF AL0.5	Aluminium-painted	1	0.400	6117412

Blanking cover with labelling panel, suited for labelling devices in Rapid 45 device installation trunking systems and ISS service poles with a 45 mm system opening.

Blanking cover, 1/2 module

Type	Colour	Pack Piece	Weight kg/100 pc.	Item no.
ADP-B RW0.5	Pure white	10	0.400	6117414
ADP-B SWGR0.5	Black-grey	10	0.400	6117415
ADP-B AL0.5	Aluminium-painted	1	0.400	6117416

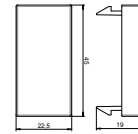

Blanking cover for closing off empty spaces for a half device (1/2 module).

Blanking cover, 1 module

Type	Colour	Pack Piece	Weight kg/100 pc.	Item no.
ADP-B RW1	Pure white	10	0.800	6117406
ADP-B SWGR1	Black-grey	10	0.800	6117407
ADP-B AL1	Aluminium-painted	1	0.800	6117408

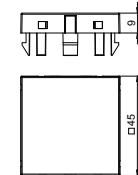

Blanking cover for closing off empty spaces for a device (one module).

One-way/changeover switch, 1/2 module

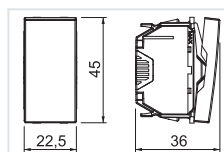

Type	WS-UB RW0.5	WS-UB SWGR0.5	WS-UB AL0.5
Colour	Pure white	Black-grey	Aluminium-painted
Pack Piece	1	1	1
Weight kg/100 pc.	1.800	1.800	1.800
Item no.	6120920	6120922	6120924

PC Polycarbonate

Changeover switch 1-pin, 10 A, 250 V~, with screwless terminals.

One-way/changeover switch with warning lamp, 1/2 module

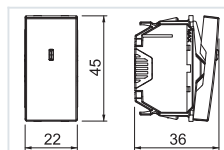

Type	WS-UKL RW0.5	WS-UKL SWGR0.5	WS-UKL AL0.5
Colour	Pure white	Black-grey	Aluminium-painted
Pack Piece	1	1	1
Weight kg/100 pc.	1.800	1.800	1.800
Item no.	6120926	6120928	6120930

PC Polycarbonate

Changeover switch with LED element as a control light, 1-pole, 10 A, 250 V~, with screwless terminals.

One-way/changeover switch, 1 module

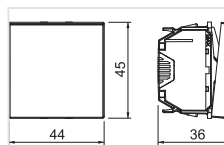





Type	WS-UB RW1	WS-UB SWGR1	WS-UB AL1
Colour	Pure white	Black-grey	Aluminium-painted
Pack Piece	1	1	1
Weight kg/100 pc.	2.600	2.600	2.300
Item no.	6120932	6120934	6120936

PC Polycarbonate

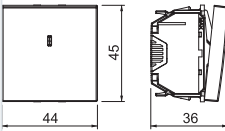
Changeover switch 1-pin, 10 A, 250 V~, with screwless terminals.

One-way/changeover switch with warning lamp, 1 module

			
Type	WS-UKL RW1	WS-UKL SWGR1	WS-UKL AL1
Colour	Pure white	Black-grey	Aluminium-painted
Pack Piece	1	1	1
Weight kg/100 pc.	2.300	2.300	2.300
Item no.	6120938	6120940	6120942
	 Polycarbonate		





Changeover switch with LED element as a control light, 1-pole, 10 A, 250 V~, with screwless terminals.

Roller blind switch, 1 module

			
Type	RS-BS RW1	RS-BS SWGR1	RS-BS AL1
Colour	Pure white	Black-grey	Aluminium-painted
Pack Piece	1	1	1
Weight kg/100 pc.	3.700	3.700	3.700
Item no.	6120950	6120952	6120954
	 Polycarbonate		

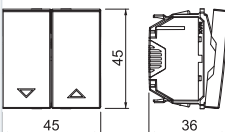
Roller blind switch with electrical and mechanical lock, 1-pin, 10 A, 250 V~, with screwless terminals.

Roller blind button, 1 module

			
Type	RT-BS RW1	RT-BS SWGR1	RT-BS AL1
Colour	Pure white	Black-grey	Aluminium-painted
Pack Piece	1	1	1
Weight kg/100 pc.	3.700	3.700	3.700
Item no.	6120980	6120982	6120984
	 Polycarbonate		

Roller blind button with electrical locking, 1-pin, 10 A, 250 V~, with screwless terminals.



Changeover switch, 1/2 module

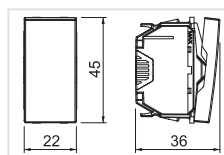

Type	TA-WB RW0.5	TA-WB SWGR0.5	TA-WB AL0.5
Colour	Pure white	Black-grey	Aluminium-painted
Pack Piece	1	1	1
Weight kg/100 pc.	1.800	1.800	1.800
Item no.	6120960	6120962	6120964

PC Polycarbonate

Changeover switch, 1-pin, 10 A, 250 V~, with screwless terminals.

Changeover switch, 1 module

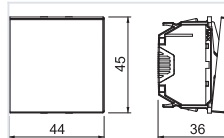

Type	TA-WB RW1	TA-WB SWGR1	TA-WB AL1
Colour	Pure white	Black-grey	Aluminium-painted
Pack Piece	1	1	1
Weight kg/100 pc.	3.300	3.300	3.300
Item no.	6120966	6120968	6120970

PC Polycarbonate

Changeover switch, 1-pin, 10 A, 250 V~, with screwless terminals.

Adapter for switch installation rotated through 90°

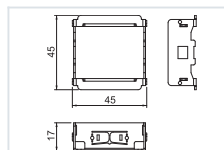



Type	AD-90G M45-1
Pack Piece	1
Weight kg/100 pc.	2.200
Item no.	6120992

St Steel

The adapter allows switch installation rotated through 90° in, for example, service poles with a 45 mm track or Rapid 45. Suitable for all switches and buttons in one module width (45 x 45 mm).

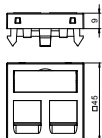

Data technology support, 1 module, straight outlet, type RM

			
	Type	DTG-2RM RW1	DTG-2RM SWGR1
Colour	Pure white	Black-grey	Aluminium-painted
Pack Piece	1	1	1
Weight kg/100 pc.	1.100	1.100	1.100
Item no.	6119292	6119294	6119296

PC Polycarbonate

The type RM data technology support is suitable for accepting the following data connection modules: Types ASM-C5, ASM-C5 G, ASM-C6 and ASM-C6 G; R&M: Cat. 5 and Cat. 6 modules without support plate.

Data technology support with straight outlet and locking slider to accept two data technology connection modules with RJ45 socket. The locking fastening is suitable for horizontal and vertical installation in the system environment. Type RM has a special module seat and is designed for indirect fastening of the data connection modules in the mounting opening.

Data technology support, 1 module, slanting outlet, type RM



			
	Type	DTS-2RM RW1	DTS-2RM SWGR1
Colour	Pure white	Black-grey	Aluminium-painted
Pack Piece	1	1	1
Weight kg/100 pc.	2.900	2.900	2.900
Item no.	6119298	6119300	6119302

PC Polycarbonate

The type RM data technology support is suitable for accepting the following data connection modules: Types ASM-C5, ASM-C5 G, ASM-C6 and ASM-C6 G; R&M: Cat. 5 and Cat. 6 modules without support plate.

Data technology support with slanting outlet and locking slider to accept two data technology connection modules with RJ45 socket. The locking fastening is suitable for horizontal and vertical installation in the system environment. Type RM has a special module seat and is designed for indirect fastening of the data connection modules in the mounting opening.

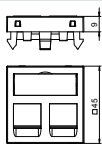
Data technology support, 1 module, straight outlet, type C

			
	Type	DTG-2C RW1	DTG-2C SWGR1
Colour	Pure white	Black-grey	Aluminium-painted
Pack Piece	1	1	1
Weight kg/100 pc.	1.100	1.100	1.100
Item no.	6119214	6119216	6119218

PC Polycarbonate

The type C data technology support is suitable for accepting the following data connection modules: BTR (Keystone design): Cat. 6A module and UAE module; Coming: modules with Keystone seat; CobiNet: CobiDat KS module; Dätwyler: KS-T, KS-TS, MS-K and KU-T; EKV: E-Stone; Harting: Prelink Keystone Cat. 6A; Fixlink Keystone Cat. 6A; Komos: KDM 500 module; Leoni Kerpen: MegaLine-Connect45 Keystone socket modules; OBO: Type ASM-C6A and ASM-C6A G; R&M: Cat. 6A with Keystone fastening; Rutenbeck: UM and UMflex; SETEC: UKJ and XKJ; Telegärtner: AMJ and UMJ.

Data technology support with straight outlet and locking slider to accept two data technology connection modules with RJ45 socket. The locking fastening is suitable for horizontal and vertical installation in the system environment. Type C has a mounting opening of 19.30 x 14.80 mm and is designed for direct fastening of the data connection modules in the mounting opening.

Data technology support, 1 module, slanting outlet, type C

Type	DTS-2C RW1	DTS-2C SWGR1	DTS-2C AL1
Colour	Pure white	Black-grey	Aluminium-painted
Pack Piece	1	1	1
Weight kg/100 pc.	1.500	1.500	1.500
Item no.	6119250	6119252	6119254

PC Polycarbonate

The type C data technology support is suitable for accepting the following data connection modules: BTR (Keystone design): Cat. 6A module and UAE module; Corning: modules with Keystone seat; CobiNet: CobiDat KS module; Dätwyler: KS-T, KS-TS, MS-K and KU-T; EKU: E-Stone; Harting: Prelink Keystone Cat. 6A; Fixlink Keystone Cat. 6A; Komos: KDM 500 module; Leoni Kerpen: MegaLine-Connect45 Keystone socket modules; OBO: Type ASM-C6A and ASM-C6A G; R&M: Cat. 6A with Keystone fastening; Rutenbeck: UM and UMflex; SETEC: UKJ and XKJ; Telegärtner: AMJ and UMJ.

Data technology support with slanting outlet and locking slider to accept two data technology connection modules with RJ45 socket. The locking fastening is suitable for horizontal and vertical installation in the system environment. Type C has a mounting opening of 19.30 x 14.80 mm and is designed for direct fastening of the data connection modules in the mounting opening.

Data technology support, 1 module, straight outlet, type A

Type	DTG-2A RW1	DTG-2A SWGR1	DTG-2A AL1
Colour	Pure white	Black-grey	Aluminium-painted
Pack Piece	1	1	1
Weight kg/100 pc.	1.100	1.100	1.100
Item no.	6119202	6119204	6119206

PC Polycarbonate

The Type A data technology support is suitable for accepting the following data connection modules: AMP TYCO (without dust protection cap): SL Series 110Connect and SL Series Toolless; Brand-Rex: modules with item numbers ending in ...JAKS000CR and ...JAKU002; Nexans: LANmark RJ45 with blue adapter clip, LANmark GG45 with metal clip.

Data technology support with straight outlet and locking slider to accept two data technology connection modules with RJ45 socket. The locking fastening is suitable for horizontal and vertical installation in the system environment. Type A has a mounting opening of 20.10 x 14.80 mm and is designed for direct fastening of the data connection modules in the mounting opening.

Data technology support, 1 module, slanting outlet, type A

Type	DTS-2A RW1	DTS-2A SWGR1	DTS-2A AL1
Colour	Pure white	Black-grey	Aluminium-painted
Pack Piece	1	1	1
Weight kg/100 pc.	2.000	1.500	1.500
Item no.	6119238	6119240	6119242

PC Polycarbonate

The Type A data technology support is suitable for accepting the following data connection modules: AMP TYCO (without dust protection cap): SL Series 110Connect and SL Series Toolless; Brand-Rex: modules with item numbers ending in ...JAKS000CR and ...JAKU002; Nexans: LANmark RJ45 with blue adapter clip, LANmark GG45 with metal clip.

Data technology support with slanting outlet and locking slider to accept two data technology connection modules with RJ45 socket. The locking fastening is suitable for horizontal and vertical installation in the system environment. Type A has a mounting opening of 20.10 x 14.80 mm and is designed for direct fastening of the data connection modules in the mounting opening.

Data technology support, 1 module, straight outlet, type B

	Type	DTG-2B RW1	DTG-2B SWGR1
Colour	Pure white	Black-grey	Aluminium-painted
Pack Piece	1	1	1
Weight kg/100 pc.	1.100	1.100	1.100
Item no.	6119208	6119210	6119212

PC Polycarbonate

The type B data technology support is suitable for accepting the following data connection modules: BTR (module design): Cat. 6A Modul, E-DAT module and UAE module; Dätwyler: MS and MS-N, Leoni Kerpen: VarioKeystone socket module Cat. 6A and MegaLine-Connect100 socket module Cat. 6A and 8C7A.

Data technology support with straight outlet and locking slider to accept two data technology connection modules with RJ45 socket. The locking fastening is suitable for horizontal and vertical installation in the system environment. Type B has a mounting opening of 19.35/21.55 x 14.85 mm and is designed for direct fastening of the data connection modules in the mounting opening.

Data technology support, 1 module, slanting outlet, type B

	Type	DTS-2B RW1	DTS-2B SWGR1
Colour	Pure white	Black-grey	Aluminium-painted
Pack Piece	1	1	1
Weight kg/100 pc.	1.500	1.500	1.500
Item no.	6119244	6119246	6119248

PC Polycarbonate

The type B data technology support is suitable for accepting the following data connection modules: BTR (module design): Cat. 6A Modul, E-DAT module and UAE module; Dätwyler: MS and MS-N, Leoni Kerpen: VarioKeystone socket module Cat. 6A and MegaLine-Connect100 socket module Cat. 6A and 8C7A.

Data technology support with slanting outlet and locking slider to accept two data technology connection modules with RJ45 socket. The locking fastening is suitable for horizontal and vertical installation in the system environment. Type B has a mounting opening of 19.35/21.55 x 14.85 mm and is designed for direct fastening of the data connection modules in the mounting opening.

Data technology support, 1 module, straight outlet, type EP



	Type	DTG-2EP RW1	DTG-2EP SWGR1
Colour	Pure white	Black-grey	Aluminium-painted
Pack Piece	1	1	1
Weight kg/100 pc.	1.100	1.100	1.100
Item no.	6119232	6119234	6119236

PC Polycarbonate

The type EP data technology support is suitable for accepting the following data connection modules: Leoni Kerpen: MegaLine-Connect45 ELine.

Data technology support with straight outlet and locking slider to accept two data technology connection modules with RJ45 socket. The locking fastening is suitable for horizontal and vertical installation in the system environment. Type EP has a special module seat and is designed for indirect fastening of the data connection modules in the mounting opening.

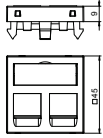
Data technology support, 1 module, straight outlet, type F

			
	Type	DTG-2F RW1	DTG-2F SWGR1
Colour	Pure white	Black-grey	Aluminium-painted
Pack Piece	1	1	1
Weight kg/100 pc.	1.100	1.100	1.100
Item no.	6119220	6119222	6119224

PC Polycarbonate

The type F data technology support is suitable for accepting the following data connection modules: Avaya/Systimax: M series.

Data technology support with straight outlet and locking slider to accept two data technology connection modules. The locking fastening is suitable for horizontal and vertical installation in the system environment.

Data technology support, 1 module, slanting outlet, type F



			
	Type	DTS-2F RW1	DTS-2F SWGR1
Colour	Pure white	Black-grey	Aluminium-painted
Pack Piece	1	1	1
Weight kg/100 pc.	1.500	1.500	1.500
Item no.	6119256	6119258	6119260

PC Polycarbonate

The type F data technology support is suitable for accepting the following data connection modules: Avaya/Systimax: M series.

Data technology support with slanting outlet and locking slider to accept two data technology connection modules with RJ45 socket. The locking fastening is suitable for horizontal and vertical installation in the system environment. Type F has a special module seat and is designed for indirect fastening of the data connection modules in the mounting opening.

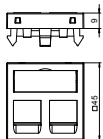
Data technology support, 1 module, straight outlet, type PA

			
	Type	DTG-2PA RW1	DTG-2PA SWGR1
Colour	Pure white	Black-grey	Aluminium-painted
Pack Piece	1	1	1
Weight kg/100 pc.	1.100	1.100	1.100
Item no.	6119226	6119228	6119230

PC Polycarbonate

The type PA data technology support is suitable for accepting the following data connection modules: Panduit: Mini-Com.

Data technology support with straight outlet and locking slider to accept two data technology connection modules with RJ45 socket. The locking fastening is suitable for horizontal and vertical installation in the system environment. Type PA has a special module seat and is designed for indirect fastening of the data connection modules in the mounting opening.



USB 2.0/3.0 connection, 1 module, straight outlet, with connection cable

Type	MTG-U3A F RW1	MTG-U3A F SWGR1	MTG-U3A F AL1
Colour	Pure white	Black-grey	Aluminium-painted
Pack Piece	1	1	1
Weight kg/100 pc.	6.000	6.000	6.000
Item no.	6104922	6104925	6104928
	PC Polycarbonate		
Multimedia support with one USB 3.0 connection socket, straight cable outlet, with labelling panel, short USB 3.0 type A connection cable, socket-socket version. Support plate with locking fastening, suitable for horizontal and vertical installation in the system environment.			

USB 2.0/3.0 connection, 1 module, slanting outlet, with connection cable

Type	MTS-U3A F RW1	MTS-U3A F SWGR1	MTS-U3A F AL1
Colour	Pure white	Black-grey	Aluminium-painted
Pack Piece	1	1	1
Weight kg/100 pc.	6.200	6.200	6.200
Item no.	6104934	6104937	6104940
	PC Polycarbonate		
Multimedia support with one USB 3.0 connection socket, slanting cable outlet, with labelling panel, short USB 3.0 type A connection cable, socket-socket version. Support plate with locking fastening, suitable for horizontal and vertical installation in the system environment.			



PC

Flush-mount unit for data technology, type A

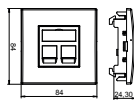

Type	Colour	Pack	Weight	Item no.
		Piece	kg/100 pc.	
DTE-RW G2A1	Pure white	4	5.000	6119494

Installation unit to accommodate two type A data technology modules, suitable for installation in Rapid 80 device installation trunking systems and ISS service poles. The type A data technology support is suitable for accepting the following data connection modules: AMP TYCO (without dust protection cap): SL Series 110Connect and SL Series Toolless; Brand-Rex: modules with item numbers ending in ...JAKS000CR and ...JAKU002; Nexans: LANmark RJ45 with blue adapter clip, LANmark GG45 with metal clip.

- Installation unit, consisting of:
- Mounting support, single, type 71MT1 45
 - Data technology support, straight outlet, type DTG-2A, colour: see table
 - Cover frame AR45, single, without labelling panel, colour: pure white

PC

Flush-mount unit for data technology, type C

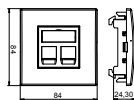

Type	Colour	Pack	Weight	Item no.
		Piece	kg/100 pc.	
DTE-RW G2C1	Pure white	4	5.000	6119492

Installation unit to accommodate two type C data technology modules, suitable for installation in Rapid 80 device installation trunking systems and ISS service poles. The type C data technology support is suitable for accepting the following data connection modules: BTR (Keystone design): Cat. 6A module and UAE module; Corning: modules with Keystone seat; CobiNet: CobiDat KS module; Dätwyler: KS-T, KS-TS, MS-K and KU-T; E-KU: E-Stone; Harting: Prelink Keystone Cat. 6A; Fixlink Keystone Cat. 6A; Komos: KDM 500 module; Leoni Kerpen: MegaLine Keystone Cat. 6A; OBO: Type ASM-C6A and ASM-C6A G; R&M: Cat. 6A with Keystone fastening; Rutenbeck: UM and UMflex; SETEC: UKJ and XKJ; Telegärtner: AMJ and UMJ.

- Installation unit, consisting of:
- Mounting support, single, type 71MT1 45
 - Data technology support, straight outlet, type DTG-2C, colour: see table
 - Cover frame AR45, single, without labelling panel, colour: pure white

Data technology solution KAT5

RJ45 data connection module, Cat. 5e, shielded

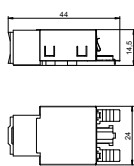

Type	Colour	Pack	Weight	Item no.
		Piece	kg/100 pc.	
ASM-C5 G		1	2.660	6117325

Connection module Cat. 5e shielded, with an RJ 45 slot. Includes an EMC screen hood, a dust cover, a cable tie and mounting instructions. Suitable for installation in data technology supports of type DTG-2RM and DTS-2RM.

RJ45 data connection module, Cat. 5e, unshielded

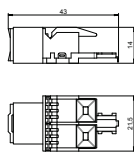

Type	Colour	Pack	Weight	Item no.
		Piece	kg/100 pc.	
ASM-C5		1	1.120	6117337

Connection module Cat. 5e unshielded, with an RJ 45 slot. Including a dust cover, a cable tie and mounting instructions. Suitable for installation in data technology supports of type DTG-2RM and DTS-2RM.

Connection module Cat. 5, shielded, snap-in

Type	Pack Piece	Weight kg/100 pc.	Item no.
ASM-C5 GS	1	1.920	6117343

Connection module Cat. 5e shielded, with an RJ45 slot. Including an EMC screen hood, a dust cover, a cable tie, a snap-in fastening frame and mounting instructions. Suitable for installation in support plates, type MTM 2C and MTM 3C, mounting plate type MPR2 2C, mounting support type MTGE2 2C, MTGE2 15 2C and MTGE2 F 2C.

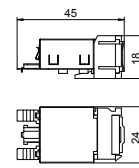

Connection module Cat. 5, unshielded, snap-in

Type	Pack Piece	Weight kg/100 pc.	Item no.
ASM-C5 S	1	1.120	6117347

Connection module Cat. 5e unshielded, with a RJ45 slot. Including a dust cover, a cable tie, a snap-in fastening frame and mounting instructions. Suitable for installation in support plates, type MTM 2C and MTM 3C, mounting plate type MPR2 2C, mounting support type MTGE2 2C, MTGE2 15 2C and MTGE2 F 2C.

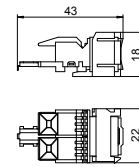

Data technology solution KAT6

RJ45 data connection module, Cat. 6, shielded

Type	Pack Piece	Weight kg/100 pc.	Item no.
ASM-C6 G	1	1.850	6117329

Connection module Cat. 6 shielded, with an RJ 45 slot. Includes an EMC screen hood, a dust cover, a cable tie and mounting instructions. Suitable for installation in data technology supports of type DTG-2RM and DTS-2RM.

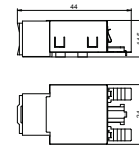

RJ45 data connection module, Cat. 6, unshielded

Type	Pack Piece	Weight kg/100 pc.	Item no.
ASM-C6	1	1.060	6117341

Connection module Cat. 6 unshielded, with an RJ 45 slot. Including a dust cover, a cable tie and mounting instructions. Suitable for installation in data technology supports of type DTG-2RM and DTS-2RM.

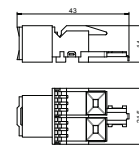

Connection module Cat. 6A, shielded, snap-in

Type	Pack Piece	Weight kg/100 pc.	Item no.
ASM-C6A G	1	1.630	6117346

Connection module Cat. 6A (ISO) shielded, with an RJ45 slot. Including an EMC screen hood, a dust cover, a cable tie, a Keystone fastening frame and mounting instructions. Suitable for installation in the data technology supports of type DTG-2C and DTS-2C, support plate of type MTM 2C and MTM 3C, mounting plate of type MPR2 2C, mounting supports of type MTGE2 2C, MTGE2 15 2C and MTGE2 F 2C.

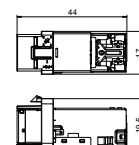

Connection module Cat. 6A, unshielded, snap-in

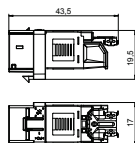

Type	Pack Piece	Weight kg/100 pc.	Item no.
ASM-C6A	1	1.050	6117348

Connection module Cat. 6A (ISO) unshielded, with an RJ45 slot. Including a dust cover, a cable tie, a Keystone fastening frame and mounting instructions. Suitable for installation in the data technology supports of type DTG-2C and DTS-2C, support plate of type MTM 2C and MTM 3C, mounting plate of type MPR2 2C, mounting supports of type MTGE2 2C, MTGE2 15 2C and MTGE2 F 2C.

Connection module Cat. 6, shielded, snap-in

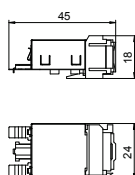

Type	Pack Piece	Weight kg/100 pc.	Item no.
ASM-C6 GS	1	1.850	6117345

Connection module Cat. 6 shielded, with an RJ45 slot. Including an EMC screen hood, a dust cover, a cable tie, a snap-in fastening frame and mounting instructions. Suitable for installation in support plates, type MTM 2C and MTM 3C, mounting plate type MPR2 2C, mounting support type MTGE2 2C, MTGE2 15 2C and MTGE2 F 2C.

Connection module Cat. 6, unshielded, snap-in

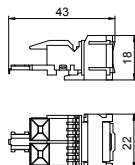

Type	Pack Piece	Weight kg/100 pc.	Item no.
ASM-C6 S	1	1.060	6117349

Connection module Cat. 6 unshielded, with an RJ45 slot. Including a dust cover, a cable tie, a snap-in fastening frame and mounting instructions. Suitable for installation in support plates, type MTM 2C and MTM 3C, mounting plate type MPR2 2C, mounting support type MTGE2 2C, MTGE2 15 2C and MTGE2 F 2C.





VGA connection, 1 module, straight outlet, with connection cable

			
	Type	MTG-VGA F RW1	MTG-VGA F SWGR1
Colour	Pure white	Black-grey	Aluminium-painted
Pack Piece	1	1	1
Weight kg/100 pc.	5.200	5.200	5.200
Item no.	6104658	6104661	6104664

PC Polycarbonate

Multimedia support with one VGA connection socket, straight cable outlet, with labelling panel, short VGA connection cable (HD15), socket-socket version. Support with locking fastening, suitable for horizontal and vertical installation in the system environment.



VGA connection, 1 module, slanting outlet, with connection cable

			
	Type	MTS-VGA F RW1	MTS-VGA F SWGR1
Colour	Pure white	Black-grey	Aluminium-painted
Pack Piece	1	1	1
Weight kg/100 pc.	6.063	5.400	5.400
Item no.	6104670	6104673	6104676

PC Polycarbonate

Multimedia support with one VGA connection socket, slanting cable outlet, with labelling panel, short VGA connection cable (HD15), socket-socket version. Support with locking fastening, suitable for horizontal and vertical installation in the system environment.

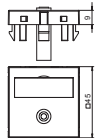
Mini jack connection, 1 module, straight outlet, as soldered connection

			
	Type	MTG-MK L RW1	
Colour	Pure white		
Pack Piece	1		
Weight kg/100 pc.	1.500		
Item no.	6104946		

PC Polycarbonate

Multimedia support with one mini jack connection socket, straight cable outlet, with labelling panel, mini cinch socket (TRS 3.5 mm) with soldered connection. Support plate with locking fastening, suitable for horizontal and vertical installation in the system environment.

Video cinch connection, 1 module, straight outlet, as 1:1 coupling

			
Type	MTG-R F RW1	MTG-R F SWGR1	MTG-R F AL1
Colour	Pure white	Black-grey	Aluminium-painted
Pack Piece	1	1	1
Weight kg/100 pc.	1.500	1.500	1.500
Item no.	6104994	6104997	6105000

PC Polycarbonate

Multimedia support with one cinch connection socket for composite video, straight cable outlet, with labelling panel, cinch coupling (RCA), socket-socket version, colour coding yellow. Support plate with locking fastening, suitable for horizontal and vertical installation in the system environment.

Video cinch connection, 1 module, slanting outlet, as 1:1 coupling

			
Type	MTS-R F RW1	MTS-R F SWGR1	MTS-R F AL1
Colour	Pure white	Black-grey	Aluminium-painted
Pack Piece	1	1	1
Weight kg/100 pc.	1.700	1.700	1.700
Item no.	6105006	6105009	6105012

PC Polycarbonate

Multimedia support with one cinch connection socket for composite video, slanting cable outlet, with labelling panel, cinch coupling (RCA), socket-socket version, colour coding yellow. Support plate with locking fastening, suitable for horizontal and vertical installation in the system environment.





Audio cinch connection, 1 module, straight outlet, as 1:1 coupling

			
Type	MTG-2R F RW1	MTG-2R F SWGR1	MTG-2R F AL1
Colour	Pure white	Black-grey	Aluminium-painted
Pack Piece	1	1	1
Weight kg/100 pc.	2.500	2.500	2.500
Item no.	6105066	6105069	6105072

PC Polycarbonate

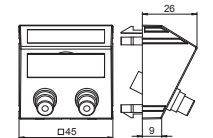
Multimedia support with two cinch connection sockets for audio R/L, straight cable outlet, with labelling panel, two cinch couplings (RCA), socket-socket version, colour coding red/white. Support plate with locking fastening, suitable for horizontal and vertical installation in the system environment.

Audio cinch connection, 1 module, slanting outlet, as 1:1 coupling

			
Type	MTS-2R F RW1	MTS-2R F SWGR1	MTS-2R F AL1
Colour	Pure white	Black-grey	Aluminium-painted
Pack Piece	1	1	1
Weight kg/100 pc.	2.700	2.700	2.700
Item no.	6105078	6105081	6105084

PC Polycarbonate

Multimedia support with two cinch connection sockets for audio R/L, slanting cable outlet, with labelling panel, two cinch couplings (RCA), socket-socket version, colour coding red/white. Support plate with locking fastening, suitable for horizontal and vertical installation in the system environment.

Component video connection, 1 module, straight outlet, as 1:1 coupling

			
Type	MTG-3R F RW1	MTG-3R F SWGR1	MTG-3R F AL1
Colour	Pure white	Black-grey	Aluminium-painted
Pack Piece	1	1	1
Weight kg/100 pc.	3.200	3.200	3.200
Item no.	6105138	6105141	6105144

PC Polycarbonate

Multimedia support with three cinch connection sockets for component video, straight cable outlet, with labelling panel, three cinch couplings (RCA), socket-socket version, colour coding red/green/blue. Support plate with locking fastening, suitable for horizontal and vertical installation in the system environment.





Component video connection, 1 module, slanting outlet, as 1:1 coupling

			
Type	MTS-3R F RW1	MTS-3R F SWGR1	MTS-3R F AL1
Colour	Pure white	Black-grey	Aluminium-painted
Pack Piece	1	1	1
Weight kg/100 pc.	3.400	3.400	3.400
Item no.	6105150	6105153	6105156

PC Polycarbonate

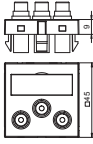



Multimedia support with three cinch connection sockets for component video, slanting cable outlet, with labelling panel, three cinch couplings (RCA), socket-socket version, colour coding red/green/blue. Support plate with locking fastening, suitable for horizontal and vertical installation in the system environment.

Audio/video cinch connection, 1 module, straight outlet, as 1:1 coupling

			
Type	MTG-12R F RW1	MTG-12R F SWGR1	MTG-12R F AL1
Colour	Pure white	Black-grey	Aluminium-painted
Pack Piece	1	1	1
Weight kg/100 pc.	3.200	3.200	3.200
Item no.	6105186	6105189	6105192
	PC Polycarbonate		

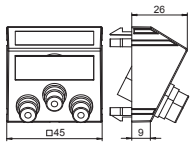

Multimedia support with three cinch connection sockets for audio/video, straight cable outlet, with labelling panel, three cinch couplings (RCA), socket-socket version, colour coding yellow/red/white. Support plate with locking fastening, suitable for horizontal and vertical installation in the system environment.

Audio/video cinch connection, 1 module, slanting outlet, as 1:1 coupling

			
Type	MTS-12R F RW1	MTS-12R F SWGR1	MTS-12R F AL1
Colour	Pure white	Black-grey	Aluminium-painted
Pack Piece	1	1	1
Weight kg/100 pc.	3.400	3.400	3.400
Item no.	6105198	6105201	6105204
	PC Polycarbonate		

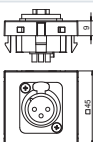

Multimedia support with three cinch connection sockets for audio/video, slanting cable outlet, with labelling panel, three cinch couplings (RCA), socket-socket version, colour coding yellow/red/white. Support plate with locking fastening, suitable for horizontal and vertical installation in the system environment.

XLR connection, 1 module, straight outlet, 3-pin socket, as soldered connection

	
Type	MTG-X3F L RW1
Colour	Pure white
Pack Piece	1
Weight kg/100 pc.	3.000
Item no.	6105210
	PC Polycarbonate

Multimedia support with one XLR connection socket, straight cable outlet, without labelling panel, 3-pin XLR socket with soldered connection. Support plate with locking fastening, suitable for horizontal and vertical installation in the system environment.

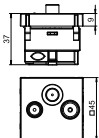
Antenna connection, 1 module, TV/radio/SAT, antenna socket

			
	Type	ANT-3SD RW1	ANT-3SD SWGR1
Colour	Pure white	Black-grey	Aluminium-painted
Pack Piece	1	1	1
Weight kg/100 pc.	11.596	11.596	11.000
Item no.	6105282	6105284	6105286



PC Polycarbonate

Socket for antenna, BK and satellite reception systems with connection for TV and radio.

Frequency: 5–2150 MHz
 Heat attenuation: 5-862 MHz - 1dB
 950-2150 MHz - 2 dB
 Return channel attenuation: 14 dB
 EMC protection class A

Digital connection solutions

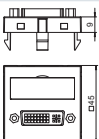

DVI-I connection, 1 module, straight outlet, with connection cable

			
	Type	MTG-DVI F RW1	MTG-DVI F SWGR1
Colour	Pure white	Black-grey	Aluminium-painted
Pack Piece	1	1	1
Weight kg/100 pc.	6.000	6.000	6.000
Item no.	6104754	6104757	6104760

PC Polycarbonate

Multimedia support with one DVI-I connection socket, straight cable outlet, with labelling panel, short DVI-I connection cable, socket-socket version. Support with locking fastening, suitable for horizontal and vertical installation in the system environment.

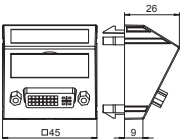
DVI-I connection, 1 module, slanting outlet, with connection cable

			
	Type	MTS-DVI F RW1	MTS-DVI F SWGR1
Colour	Pure white	Black-grey	Aluminium-painted
Pack Piece	1	1	1
Weight kg/100 pc.	6.200	6.200	6.200
Item no.	6104766	6104769	6104772

PC Polycarbonate

Multimedia support with one DVI-I connection socket, slanting cable outlet, with labelling panel, short DVI-I connection cable, socket-socket version. Support with locking fastening, suitable for horizontal and vertical installation in the system environment.

HDMI connection, 1 module, straight outlet, with connection cable

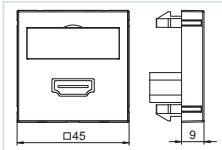

Type	MTG-HD F RW1	MTG-HD F SWGR1	MTG-HD F AL1
Colour	Pure white	Black-grey	Aluminium-painted
Pack Piece	1	1	1
Weight kg/100 pc.	6.000	6.000	6.000
Item no.	6104826	6104829	6104832

PC Polycarbonate

Multimedia support with one HDMI connection socket, straight cable outlet, with labelling panel, short HDMI connection cable, socket-socket version. Support plate with locking fastening, suitable for horizontal and vertical installation in the system environment.

HDMI connection, 1 module, slanting outlet, with connection cable

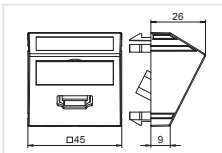

Type	MTS-HD F RW1	MTS-HD F SWGR1	MTS-HD F AL1
Colour	Pure white	Black-grey	Aluminium-painted
Pack Piece	1	1	1
Weight kg/100 pc.	6.200	6.200	6.200
Item no.	6104838	6104841	6104844

PC Polycarbonate

Multimedia support with one HDMI connection socket, slanting cable outlet, with labelling panel, short HDMI connection cable, socket-socket version. Support plate with locking fastening, suitable for horizontal and vertical installation in the system environment.

Multimedia support

Multimedia support for VGA/D-Sub9 plug connection, 1 module, straight outlet

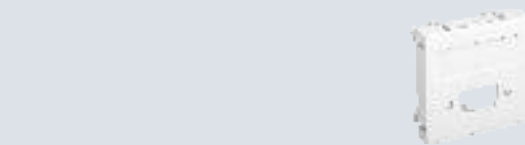
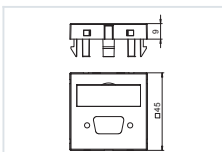

Type	MTG-DB O RW1
Colour	Pure white
Pack Piece	1
Weight kg/100 pc.	0.700
Item no.	6104706

PC Polycarbonate

Multimedia support for a VGA / D-Sub9 plug connector, straight cable outlet, with labelling panel, without plug connector. Support plate with locking fastening, suitable for horizontal and vertical installation in the system environment.

Multimedia support for VGA/D-Sub9 plug connector, 1 module, slanting outlet

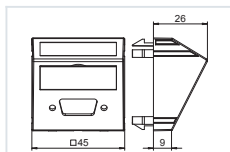

Type	MTS-DB O RW1	MTS-DB O AL1
Colour	Pure white	Aluminium-painted
Pack Piece	1	1
Weight kg/100 pc.	0.900	0.900
Item no.	6104718	6104724

PC Polycarbonate

Multimedia support for a VGA / D-Sub9 plug connector, slanting cable outlet, with labelling panel, without plug connector. Support plate with locking fastening, suitable for horizontal and vertical installation in the system environment.

Multimedia support for XLR plug connector, 1 module, straight outlet

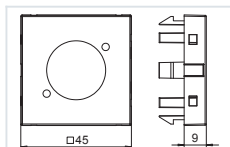

Type	MTG-X O RW1	MTG-X O SWGR1	MTG-X O AL1
Colour	Pure white	Black-grey	Aluminium-painted
Pack Piece	1	1	1
Weight kg/100 pc.	0.600	0.600	0.600
Item no.	6105234	6105237	6105240

PC Polycarbonate

Multimedia support for an XLR plug connector, straight cable outlet, without labelling panel, without plug connector. Support plate with locking fastening, suitable for horizontal and vertical installation in the system environment.





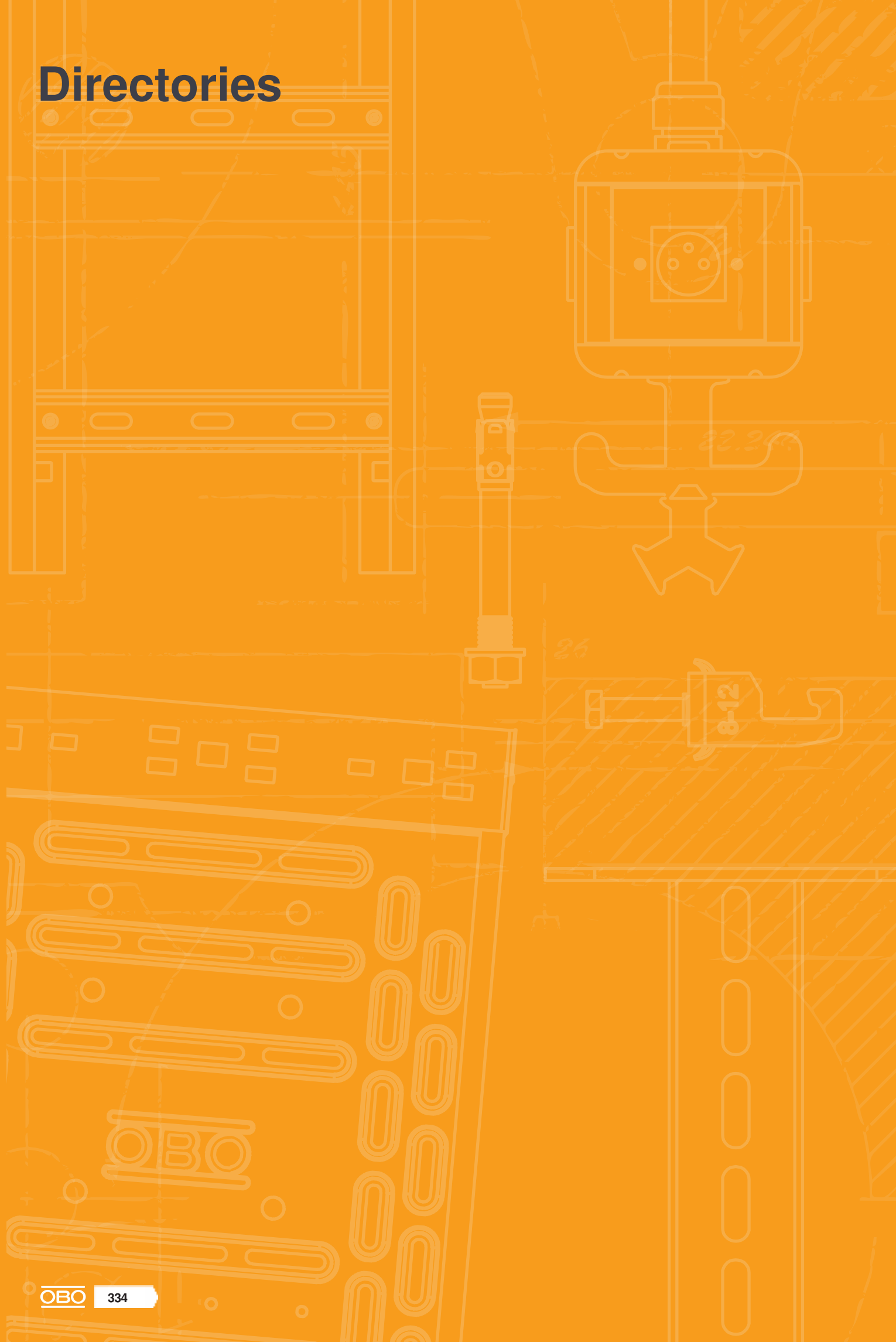

Directories





























Directories

	Test marks	336
	Pictogram explanation	338
	Numeric directory	342

























Test marks

	American Bureau of Shipping, USA		Underwriters Laboratories Inc., USA + CSA, Canada
	AENOR, Producto Certificado, Spain		Österreichischer Verband für Elektrotechnik, Austria
	STOWARZYSZENIE ELEKTRYKÓW POLSKICH, Poland		ISTITUTO ITALIANO DEL MARCHO DI QUALITÀ, Italy
	Lightning current-tested		RINA 1861, Ship Classification, Certification and Services
	Lightning current-tested, Class H (100 kA)		Underwriters Laboratories Inc., USA
	CEBEC, Belgium		SEMKO An Inchcape Testing Services Company, Sweden
	Canadian Standards Association, Canada		Eidgenössisches Starkstrominspektorat, Switzerland
	DEMKO, Danmarks Elektriske Materielkontrol, Denmark		South African Bureau of Standards
	Deutsches Institut für Bautechnik Berlin, Germany		Shock-tested, Bundesamt für Zivilschutz, Germany
	Det Norske Veritas		Sähkötarkastuskeskus Elinspektionscentralen Electrical Inspectorate, Finland
	ENEC Austria		Underwriters Laboratories Inc., USA
	ATEX certificate for explosive areas		Underwriters Laboratories Inc., USA
	ELEKTROTECHNICKÝ ZKUŠEBNÍ ÚSTAV, Czech Republic		Verband der Elektrotechnik, Elektronik, Informationstechnik e.V., Germany
	FIMKO, Finland		German Association of Electricians, tested safety
	Forschungs- und Materialprüfungsanstalt, Germany		5-year warranty
	Russia, GOST The State Committee for Standards		
	Test marks for technical resources, VDE Prüf- und Zertifizierungsinstitut Offenbach, Germany		
	Halogen-free; without chlorine, fluorine and bromine		
	INMETRO, Brazil		
	KEMA-KEUR, Netherlands		
	Indication of metric products		
	MAGYAR ELEKTROTECHNIKAI ELLENŐRZŐ INTÉZET Budapest, Hungary		
	NEMKO, Norway		
	AFNOR Quality symbol of the French standardisation institute		





Pictogram explanation





Surfaces

	Strip galvanised
	Strip galvanised/plastic-coated
	Strip galvanised zinc/aluminium, double dip
	Bright
	Bright, reworked
	Anodised
	Hot-dip galvanised
	Electrogalvanised
	Electrogalvanised/plastic-coated
	Electrogalvanised, yellow-chromated
	Electrogalvanised, yellow passivated
	Electrogalvanised, transparently passivated
	Primed
	Painted
	Welding primed
	Hot-dip galvanised
	Hot-dip galvanised 85 µm
	Copper-plated
	Nickel-plated
	Galvanised, Deltatone 500
	Galvanised, MAGNI 565
	Zinc-aluminium coated, Galfan
	Zinc scale





Conformity symbol

	Communautés Européennes, EC declaration of conformity according to EC directives
	RoHS-conformant



















Quality marks

	Halogen-free; without chlorine, fluorine and bromine
	Flame resistant 650 °C
	Flame resistant 750 °C
	Flame resistant 960 °C
	UV-resistant



Specific product symbols

	Diameter 60 mm
	Diameter 68 mm
	Protection device to DIN EN 61643-11 or IEC 61643-11
	Transition from LPZ 2 to LPZ 3
	Acoustic signalling

Applications



	Remote signalling
	Acoustic signalling
	Integrated Service Digital Network, ISDN applications
	Digital Subscriber Line, DSL applications
	Analogue telecommunication
	Category 5 TwisterPair
	Channel Performance to American EIA/TIA standard
	Measuring, controlling and regulating systems
	TV applications
	SAT-TV applications
	MultiBase base
	LifeControl
	Intrinsically safe protection device for potentially explosive areas
	Channel Performance to ISO/IEC 11801
	Power over Ethernet
	230/400 V system
	Protection rating IP 54
	Protection rating IP 65

Lightning protection classes







	Protection device to DIN EN 61643-11 or IEC 61643-11
	Combination protection device made of type 1 and type 2
	Protection device to DIN EN 61643-11 or IEC 61643-11







Lightning protection classes

	Protection device to DIN EN 61643-11 or IEC 61643-11
	Protection device to DIN EN 61643-11 or IEC 61643-11



Lightning protection zone

	Transition from LPZ 0 to LPZ 1
	Transition from LPZ 0 to LPZ 2
	Transition from LPZ 0 to LPZ 3
	Transition from LPZ 1 to LPZ 2
	Transition from LPZ 1 to LPZ 3
	Transition from LPZ 2 to LPZ 3



BSS maintenance of electrical function installation

	Fire-tested systems
	Escape route ceiling mounting with pressure clip
	OBO Grip, wall routing type
	OBO Grip, ceiling routing type
	Pressure clip for maintenance of electrical function, ceiling mounting



BSS anchor

	Fire protection anchor
	Fire protection bolt tie

BSS test marks/material class

	Maintenance of electrical function class E30
	Maintenance of electrical function class E90













Clamp clip base shapes

	Clamp clip for C profile rail, slot width 11–12 mm
	Clamp clip for C profile rail, slot width 16–17 mm
	Clamp clip for C profile rail, slot width 18–22 mm



Diameter

	Diameter 60 mm
	Diameter 68 mm
	Diameter 70 mm
	Diameter 74 mm





Entries

	4 cable entries
	6 cable entries
	7 cable entries
	8 cable entries
	9 cable entries
	10 cable entries
	12 cable entries
	10 cable entries ECO
	12 cable entries ECO
	14 cable entries ECO
	16 cable entries
	18 cable entries ECO
	24 cable entries





Gland thread

	Thread metric
	Thread Pg





Entry size

	M20 entry
	M25 entry
	M32 entry
	M40 entry

KTS side heights

	Cable tray, side height 35 mm
	Cable tray, side height 60 mm
	Cable tray, side height 85 mm
	Mesh cable tray, side height 35 mm
	Mesh cable tray, side height 55 mm









Materials

	Flat steel
	Angular steel
	U steel
	Round material





Pictogram explanation







Nominal cross-section

	Nominal cross-section 1.5 mm ²
	Nominal cross-section 1.5–2.5 mm ²
	Nominal cross-section 2.5 mm ²
	Nominal cross-section 2.5–4 mm ²
	Nominal cross-section 4 mm ²
	Nominal cross-section 4–6 mm ²
	Nominal cross-section 6 mm ²
	Nominal cross-section 10 mm ²
	Nominal cross-section 16 mm ²





Nominal voltage

	Nominal voltage 400 V
	Nominal voltage 500 V
	Nominal voltage 660 V





Polarity

	3-pole
	5-pole
	7-pole
	8-pole
	10-pole
	12-pole

Slot widths

	Slot width 7.5 mm
	Slot width 11 mm
	Slot width 11–12 mm
	Slot width 12 mm
	Slot width 15 mm
	Slot width 16 mm
	Slot width 16.5 mm
	Slot width 16–17 mm
	Slot width 17 mm
	Slot width 18 mm
	Slot width 22 mm
	Slot width 35 mm











Screw heads

	Philips screw
	Torx screw
	Phillips screw
	Pozidriv











Firing devices

	Bolt-firing tool
	Nail device





Protection rating

	Protection rating IP 20
	Protection rating IP 30
	Protection rating IP 31
	Protection rating IP 44
	Protection rating IP 54
	Protection rating IP 55
	Protection rating IP 65
	Protection rating IP 66
	Protection rating IP 67
	Protection rating IP 68

Metals

	Aluminium
	Aluminium/steel
	Stainless steel, rustproof
	Stainless steel, rustproof
	Stainless steel, rustproof
	Copper
	Brass
	Steel
	Malleable iron
	Die-cast zinc

Plastics

	Acrylonitrile butadiene styrene
	Duroplast, Aminoplast, type 131.5
	Duroplast, melamine resin, type 150
	Ethylene vinyl acetate



Plastics

FA	Fibre-proof material DIN 28091
GFK	Fibreglass-reinforced plastic
NBR SBR	Rubber mixture
NBR	Nitrile rubber
PETR	Petrolatum
PA	Polyamide
PA/ GF	Polyamide, fibre-glass reinforced
PBPT	Polybutylene terephthalate
PC	Polycarbonate
PE	Polyethylene
PP	Polypropylene
PP/GF	Polypropylene, fibre-glass reinforced
PS	Polystyrene
PVC	Polyvinylchloride
ZELL PE	Cellular polyethylene



Numeric directory

GTIN	Item no.	Page	GTIN	Item no.	Page	GTIN	Item no.	Page	GTIN	Item no.	Page	GTIN	Item no.	Page
5669197	/100 pc. 2351056	121	6028276	/pc. 6024874	62	5898764	6104772	330	5124436	/pc. 6108454	284	6419036	6113000	126
	price/m		6028337	6024882	63	5899013	6104826	331	5124498	6108457	284	6419074	6113002	126
6362530	6020801	248	6651375	6024904	64	5899020	6104829	331	5124542	6108459	284	6710980	6113003	126
	price/m		6667338	price/m 6024947	19	5899044	6104832	331	5124788	6108477	285		price/m	
6016877	6021018	41	7005054	6024949	19	5899082	6104838	331	5124801	6108479	285	6419081	6113010	128
7005177	6021023	41		price/m 6024955	19	5899105	6104841	331	5124856	6108482	285	6419104	6113012	128
	price/m		6642250	price/m 6024971	19	5899150	6104844	331	5124894	6108484	285		/pc.	
6016990	6021034	43	6642373	6024971	19	5899648	6104922	320	6688623	6108700	292	6419111	6113020	126
	/pc.					5899709	6104928	320	6688470	6108712	290	6419142	6113022	126
6017171	6021093	41	6332779	6025005	20	5899754	6104933	320	6688463	6108710	290	6419142	6113022	126
6017652	6021190	41	6332892	6025021	20	5899808	6104934	320	6688470	6108712	290	6419142	6113022	126
6018253	6021336	42	6794539	6025048	20	5899853	6104937	320	6688470	6108716	290	6419142	6113022	126
6018857	6021492	40	6667390	6025102	24	5899884	6104940	320	6688494	6108716	290	6419173	6113040	127
6018918	6021506	42	6028399	6025110	24	5899921	6104946	326	6688500	6108718	290	6419197	6113042	127
6018970	6021514	44	6028450	6025129	24	5900238	6104994	327	6688517	6108720	290	7264864	6113045	141
6019212	6021697	39	6028511	6025137	22	5900245	6104997	327	6688524	6108722	290		/pc.	
6019274	6021700	43	7005085	6025155	24	5900283	6105000	327	6688531	6108724	290	6419203	6113050	128
6019335	6021719	39		price/m		5900290	6105006	327	6688548	6108730	290	6419210	6113052	128
6019397	6021727	43	6028931	6025420	37	5900306	6105009	327	6688555	6108732	290	6419227	6113060	127
6019458	6021735	39	6028993	6025447	37	5900337	6105012	327	6688562	6108734	290	6419234	6113060	127
6019519	6021743	44	6029051	6025617	39	5900352	6105012	327	6688579	6108736	290	6419237	6113062	127
	price/m		6029112	6025633	39	5900549	6105066	327	6688586	6108738	290	7264840	6113065	141
6019939	6021867	55	7005146	6025638	39	5900556	6105069	327	6688593	6108740	290		/pc.	
	price/m			price/m		5900569	6105072	327	6688609	6108742	290	6419258	6113070	127
	price/m		6029174	6025668	45	5900573	6105078	328	6688616	6108744	290	6419265	6113072	127
6020232	6022006	47		price/m		5900581	6105081	328	6688203	6108950	291	6418015	6113074	146
6020294	6022014	49		price/m		5900587	6105084	328	6688210	6108952	291	6419272	6113080	126
6020355	6022022	51	6029778	6026176	61	5899204	6105138	328	6688227	6108954	291	6419289	6113082	126
6637515	6022030	53	6029839	6026184	61	5899228	6105141	328	6688234	6108956	291	7264888	6113085	140
6020416	6022049	55	6029891	6026192	62	5899259	6105144	328	6688241	6108960	291		/pc.	
6638895	6022057	59	6030132	6026273	63	5899273	6105150	328	6688258	6108962	291	6419296	6113090	127
6020478	6022065	57	6030194	6026281	63	5899457	6105153	328	6688265	6108964	291	6419319	6113092	127
	/pc.		6642076	6026311	64	5899463	6105156	328	6688272	6108966	291	6418046	6113094	146
6020539	6022073	45	6642137	6026338	64	5899694	6105186	329	6688289	6108972	292	6419330	6113100	128
6020713	6022111	47	6667451	6026354	26	5899730	6105189	329	6688296	6108974	292	6419343	6113102	128
6020836	6022146	49	6642793	6026362	26	5899747	6105192	329	6688302	6108974	292	6418176	6113104	147
6020959	6022162	51	6667512	6026400	29	5899761	6105198	329		price/m		6419357	6113112	128
6021079	6022189	55	6030255	6026419	29	5899815	6105201	329	6417902	6112400	145	6418206	6113114	147
6021130	6022197	57	6030439	6026443	31	5899822	6105204	329	6417919	6112403	145		price/m	
6021253	6022219	47	6794591	6026486	31	5899866	6105210	329	6417926	6112410	147	6419388	6113200	130
6021376	6022235	49	7005115	6026488	31	5900115	6105234	332	6417933	6112413	147	6419395	6113202	130
6021499	6022251	51		price/m		5900177	6105237	332		/pc.			/pc.	
6021611	6022286	55	6667574	6026796	33	5900184	6105240	332	6417964	6112420	146	6419418	6113210	130
6021673	6022294	57	6332953	6026818	33	6164752	6105282	330	6417971	6112423	146	6419432	6113212	130
6021796	6022316	48	6333073	6026834	33	6164769	6105284	330	6417995	6112430	146	6418268	6113214	149
6021918	6022332	50	6667635	6026842	35	6164790	6105286	330	6418008	6112433	146	6419456	6113220	131
6022038	6022359	51	6640874	6026850	35	6594603	6105300	309	6418022	6112440	145	6419463	6113222	131
6022151	6022375	55	6030675	6026982	120	6594641	6105302	309	6418039	6112443	145	6419470	6113230	131
6022212	6022383	45	6030736	6026990	121	6594665	6105304	309		price/m		6419500	6113232	131
6022274	6022391	57							6418213	6112500	149	6418305	6113234	151
6022519	6022448	45	6667697	6027016	37	5699767	6107801	288	6418251	6112503	149	6419517	6113240	131
6022694	6022499	46	6667758	6027024	39					/pc.		6419531	6113242	131
6022755	6022502	48	6667819	6027032	41	5273530	6108050	285	6418275	6112510	150	6419555	6113250	131
6022816	6022529	52	6667871	6027040	43	5273547	6108051	285	6418299	6112513	150	6419562	6113252	131
6022878	6022545	56	6667994	6027105	45	5273585	6108052	286	6418329	6112520	150	6418312	6113254	150
6022939	6022561	58	6668052	6027113	47	5273592	6108053	286	6418336	6112523	150	6419586	6113260	130
6022991	6022588	50	6668113	6027121	49	5273608	6108054	286	6418350	6112530	149	6419609	6113262	130
			6668175	6027148	51	5273646	6108055	286	6418367	6112533	149	6419616	6113270	131
6023837	6023002	48	6668236	6027156	53	5273653	6108056	287		price/m		6419630	6113272	131
6023950	6023029	50	6668298	6027164	55	5273660	6108057	287	6418503	6112600	153	6418374	6113274	150
6024070	6023045	52	6668359	6027172	57	6584680	6108060	286	6418534	6112603	153	6419647	6113280	132
6024193	6023061	56	6668410	6027180	59	6584697	6108062	286		/pc.		6419661	6113282	132
	price/m		6668472	6027229	61	6584703	6108064	286	6418558	6112610	154	6418381	6113284	151
6024315	6023096	120	6668533	6027237	62	6584734	6108066	286	6418541	6112613	154		price/m	
6024377	6023118	120	6668595</											

GTIN	Item no.	Page	GTIN	Item no.	Page	GTIN	Item no.	Page	GTIN	Item no.	Page	GTIN	Item no.	Page
	/pc.			/pc.			/pc.			price/m			price/m	
6418565	6113424	155	5670933	6117196	284	5889328	6119433	305	6097753	6150187	13	6801671	6168736	27
6419999	6113430	134	5670940	6117197	284	5889366	6119435	305	6493159	6150268	12	6802159	6168744	27
6420001	6113432	134	5438113	6117198	284	6060963	6119483	306	6493098	6150276	12			
6420032	6113440	134	6235155	6117325	322	6609994	6119485	306	6493036	6150284	12	5933779	6175375	66
6420049	6113442	134	6235216	6117329	323	6410439	6119492	322	6492978	6150292	13	5933984	6175377	66
6418602	6113444	154	6235278	6117337	322	6439041	6119494	322	6975686	6150640	31	5933953	6175390	68
6420056	6113450	133	6235339	6117341	323				6492251	6150764	15	5933991	6175392	68
6420063	6113452	133	5402428	6117343	323	6049134	6120001	309	6491773	6150780	17	5812456	6175400	70
6420094	6113460	134	5402435	6117345	324	6049127	6120003	309				5812463	6175405	72
6420100	6113462	134	5887515	6117346	323	6049189	6120005	309				5812470	6175410	74
6418633	6113464	154	5402442	6117347	323	6046966	6120008	300	6492138	6154026	15	5812487	6175415	76
6420117	6113470	135	5887522	6117348	324	6046973	6120010	300	6491650	6154034	17	5812494	6175420	78
6420124	6113472	135	5402459	6117349	324	6047024	6120012	300	6974481	6154069	27	5812500	6175425	80
6418657	6113474	155	6117499	6117406	311	6047031	6120014	300	6491957	6154115	16	5933977	6175457	68
6420155	6113480	135	5701279	6117407	311	6047086	6120016	300	6491476	6154123	18	5817789	6175460	70
6420162	6113482	135	6214037	6117408	311	6047093	6120018	300	6493272	6154166	28	5817796	6175463	72
6418664	6113484	155	6164813	6117410	310	6047109	6120022	300	6491896	6154212	16	5817802	6175466	74
			6164820	6117411	310	6047130	6120024	300	6491414	6154220	18	5817833	6175469	76
7257545	6114157	140	6164851	6117412	310	6047147	6120026	300	6493333	6154255	28	5817840	6175472	78
7257538	6114162	142	6117550	6117414	311	6047154	6120028	300	6492077	6154328	15	5817857	6175475	80
7257521	6114166	142	5701286	6117415	311	6047208	6120030	300	6491599	6154336	17	5812517	6175500	120
	price/m		6215652	6117416	311	6047222	6120032	300	6974542	6154360	28	5812524	6175504	120
6450824	6114200	173	6133833	6117420	310	6047260	6120042	300	6492015	6154417	15			
6450831	6114210	174	6133840	6117421	310	6047277	6120044	300	6491537	6154425	17	5933946	6175540	67
	/pc.		6133857	6117422	310	6047321	6120046	300	6493210	6154468	28	5934233	6175546	69
6450848	6114220	174				6047345	6120048	300	6491834	6154514	16	5813910	6175550	71
6450893	6114230	174	5696896	6119202	317	6047383	6120050	300	6491353	6154522	18	5813927	6175554	73
6450909	6114240	174	5696902	6119204	317	6047390	6120052	300	6493395	6154557	28	5813934	6175558	75
6450930	6114250	175	5696940	6119206	317	7255572	6120073	302				5813941	6175562	77
6451012	6114260	175	5696957	6119208	318	7255565	6120075	302	6577576	6158226	24	5813958	6175566	79
6451111	6114270	175	5696964	6119210	318	7255589	6120077	302	6577750	6158234	20	5813965	6175570	81
6451166	6114280	175	5696971	6119212	318	7255633	6120079	302	6577934	6158242	22	5933809	6175572	66
	price/m		5696988	6119214	316	7255688	6120081	302	6578115	6158250	29	5934073	6175578	68
6451173	6114290	176	5696995	6119216	316	7255732	6120083	302	6578290	6158269	32	5922780	6175581	70
6451180	6114300	177	5697008	6119218	316	7255787	6120103	302	6578658	6158285	33	5814016	6175590	72
	/pc.		5697015	6119220	319	7255879	6120105	302	6578832	6158293	37	5814023	6175594	74
6451197	6114320	178	5697022	6119222	319	7255923	6120107	302	6641352	6158307	35	5814030	6175598	76
6451241	6114340	178	5697039	6119224	319	7256005	6120109	302	6578955	6158331	24	5814047	6175602	78
6451296	6114360	179	5697046	6119226	319	7256050	6120111	302	6579136	6158358	20	5814054	6175606	80
6451319	6114370	179	5697053	6119228	319	7256128	6120114	302	6579310	6158366	22	5933830	6175612	67
6451364	6114380	179	5697060	6119230	319	7256173	6120123	302	6579495	6158374	29	5934127	6175618	69
	price/m		5697077	6119232	318	7256227	6120125	302	6579679	6158382	32	5922841	6175624	70
5914075	6115775	236	5697084	6119234	318	7256272	6120127	302	6580033	6158404	33	5814061	6175626	72
	/pc.		5697121	6119236	318	7256326	6120129	302	6580217	6158412	37	5814078	6175630	74
5914211	6115789	237	5697138	6119238	317	7256371	6120131	302	6641536	6158420	35	5814085	6175634	76
5914297	6115795	238	5697145	6119240	317	7256449	6120133	302	6580392	6158455	25	5814092	6175638	78
5914150	6115825	236	5697183	6119242	317				6580576	6158463	21	5814108	6175642	80
5914174	6115835	236	5697190	6119244	318	6049073	6120292	301	6580750	6158471	23	5933885	6175648	67
5914198	6115845	237	5697206	6119246	318	6049141	6120294	301	6580934	6158498	30	5934158	6175654	69
5914235	6115851	237	5697244	6119248	318	6049196	6120296	301	6581115	6158501	32	5922896	6175658	70
5914259	6115855	237	5697251	6119250	317	6049240	6120302	303	6581474	6158536	34	5814115	6175662	72
5914273	6115865	237	5697268	6119252	317	6049257	6120304	303	6581658	6158544	38	5814122	6175666	74
5914310	6115875	238	5697305	6119254	317	6049264	6120306	303	6641895	6158552	36	5814139	6175670	76
5914334	6115885	238	5697312	6119256	319	6333578	6120782	310	6581832	6158587	24	5814146	6175674	78
5914358	6115895	238	5697329	6119258	319	6602889	6120797	310	6582013	6158595	21	5814153	6175678	80
5914372	6115915	238	5697374	6119260	319	6570805	6120920	312	6582198	6158609	23	5933915	6175684	67
5914396	6115925	239	5887430	6119292	316	6570812	6120922	312	6582372	6158617	29	5934189	6175690	69
5914419	6115935	239	5887447	6119294	316	6570829	6120924	312	6582556	6158625	32	5922926	6175694	71
5914433	6115945	239	5887454	6119296	316	6570836	6120926	312	6582914	6158641	33	5814160	6175698	73
5914457	6115955	239	5888024	6119298	316	6570843	6120928	312	6583096	6158668	37	5814177	6175702	75
5914471	6115965	239	5887492	6119300	316	6570850	6120930	312	6641710	6158676	35	5814184	6175706	77
5914495	6115975	240	5887508	6119302	316	6570867	6120932	312	6642618	6158692	19	5814191	6175710	79
5914501														

Numeric directory

GTIN	Item no.	Page	GTIN	Item no.	Page	GTIN	Item no.	Page	GTIN	Item no.	Page	GTIN	Item no.	Page
	/pc.			/pc.			/pc.			price/m			/pc.	
5815037	6176040	72	6674299	6183727	38	6796212	6192459	21	6312252	6247164	111	6315130	6249647	108
5815044	6176044	74	6674350	6183735	40	6494774	6192467	23	5691006	6247194	115	6315192	6249655	112
5815075	6176048	76	6674411	6183743	42	6796274	6192475	25				6503537	6249671	101
5815082	6176052	78	6674473	6183751	44	6504978	6192483	30	6652754	6247431	85	6318254	6249701	105
5815099	6176056	80	6678372	6183808	46	6796335	6192491	32	6118991	6247434	87	6318315	6249728	109
5922971	6176072	71	6678433	6183816	48	6796397	6192513	34	6315253	6247458	91	6318377	6249736	113
5815105	6176076	73	6678495	6183824	50	6497232	6192521	36	6315314	6247466	99	6503292	6249795	101
5815112	6176080	75	6678556	6183832	52	6796458	6192548	38	5699019	6247472	115	6575770	6249817	106
5815129	6176084	77	6678617	6183840	54	6796519	6192556	40	6652518	6247490	93	6575831	6249825	109
5815136	6176088	79	6678679	6183859	56	6796571	6192564	42	6312313	6247504	97	6575893	6249833	113
5815143	6176092	81	6678730	6183867	58	6500833	6192572	44	6652273	6247563	92	6018598	6249842	86
			6678792	6183875	60	6351794	6192610	46	6312733	6247571	96	6018710	6249844	88
6674657	6182011	24	6678853	6183913	61	6492435	6192629	48	6652150	6247652	92	6018833	6249846	94
6674718	6182062	29	6678914	6183921	62	6712519	6192637	50	6313150	6247660	96	6863686	6249847	90
6674770	6182097	33	6678976	6183956	63	6712571	6192645	52	6652396	6247725	92			
6674831	6182100	35	6679034	6183980	64	6492497	6192653	54	6317592	6247733	96	6018956	6249848	98
6674893	6182119	37				6712632	6192661	56	6652631	6247881	93	6019076	6249850	102
6674954	6182127	39				6796632	6192688	58	6575114	6247903	97	5020325	6249852	106
6675012	6182135	41	6794058	6191002	19	6492558	6192696	59	6503476	6247989	101	5020387	6249854	110
6675074	6182143	43	6794119	6191010	20	6796694	6192750	21				5020394	6249856	114
6675739	6182194	45	6494590	6191029	22	6494835	6192769	23	6312559	6248004	105	5691037	6249865	118
6675791	6182208	47	6794171	6191037	24	6796755	6192777	24	6312610	6248012	109	6678006	6249871	121
6675852	6182216	49	6496938	6191045	26	6504916	6192785	29	6312672	6248020	113			
6675913	6182224	51	6505036	6191053	29	6796816	6192793	32	6977062	6248047	100	6644896	6249876	121
6675975	6182232	53	6794232	6191061	31	6796878	6192815	33	6312979	6248063	104	5762898	6249880	121
6676033	6182240	55	6794294	6191096	33	6497294	6192823	35	6313037	6248071	108			
6676095	6182259	57	6497058	6191118	35	6796939	6192831	37	6313099	6248098	112	5685081	6249881	103
6676156	6182267	59	6363490	6191126	37	6796991	6192858	39	6977185	6248128	100			
6675197	6182402	24	6794355	6191134	39	6797059	6192866	42	6313396	6248144	104	6316632	6270727	244
6675258	6182445	29	6794416	6191142	41	6496990	6192874	44	6313457	6248152	108			
6675319	6182488	33	6501199	6191150	43	6712694	6192912	45	6313518	6248160	112	5846390	6274210	161
6675371	6182496	35	6363018	6191193	45	6492619	6192920	48	6503599	6248187	100	5846406	6274211	161
6675432	6182526	37	6491292	6191207	47	6712755	6192939	50	6317837	6248209	105	5846413	6274212	161
6675494	6182534	39	6363438	6191215	49	6712816	6192947	51	6317899	6248217	108	5846574	6274220	161
6675555	6182542	41	6363377	6191223	51	6492671	6192955	53	6317950	6248225	112	5846581	6274221	161
6675616	6182550	43	6491230	6191231	53	6712878	6192963	55	6503353	6248284	101	5846598	6274222	161
6676392	6182593	45	6363193	6191258	55	6797110	6192971	57	6575596	6248306	105	5846475	6274240	162
6676453	6182607	47	6794478	6191266	57	6492732	6192998	60	6575657	6248314	109	5846482	6274241	162
6676514	6182615	49	6799459	6191274	59				6575718	6248322	113	5846512	6274282	162
6676576	6182623	51	5042273	6191304	61	6797172	6193099	19	5699026	6248328	117			
6676637	6182631	53	5042280	6191312	62	6797233	6193102	21	5699033	6248332	116	5655473	6274300	160
6676699	6182658	55	5042297	6191347	63	6975624	6193110	23	5699040	6248336	116	5656333	6274301	160
6676750	6182666	57	5042303	6191355	64	6797295	6193129	25	5699057	6248340	116	5656340	6274302	160
6676811	6182674	59				6976768	6193137	26	5699064	6248344	117	5656371	6274306	160
6677285	6182801	25	6794652	6191843	20	6504794	6193145	30	5699095	6248428	117			
6677291	6182852	30	6494651	6191851	22	6797356	6193153	32	5699101	6248432	116	5656401	6274310	161
6677297	6182887	34	6794713	6191878	24	6797417	6193188	34	5699118	6248436	116	5656432	6274311	161
6677303	6182895	36	6502219	6191886	29	6497355	6193196	36	5699125	6248450	117	5656449	6274312	161
6677309	6182917	38	6794775	6191894	32	6712939	6193218	38	5699156	6248454	117	5656456	6274316	161
6677315	6182925	40	6794836	6191924	33	6797479	6193226	40				5655664	6274320	162
6677321	6182933	42	6976829	6191932	35	6797530	6193234	42	6651795	6248462	85	5656463	6274321	162
6677327	6182941	44	6794898	6191940	37	6974788	6193242	44	6119059	6248470	87	5656494	6274322	162
			6794959	6191959	39	6712991	6193285	46	6746873	6248489	89	5656500	6274326	162
6677054	6183018	46	6795017	6191967	41	6492794	6193293	48				5656517	6274340	162
6677115	6183026	48	6221110	6191975	43	6713059	6193307	50	6651856	6248497	91	5656524	6274341	162
6677177	6183034	50				6713110	6193315	52	6313570	6248519	95	5656555	6274342	162
6677238	6183042	52	6362950	6192017	45	6492855	6193323	54	6977307	6248608	99	5656562	6274346	162
6677290	6183050	54	6799879	6192025	47	6713172	6193331	56	6313815	6248624	103	5656579	6274360	162
6677351	6183069	56	6362776	6192033	49	6797592	6193358	58	6313877	6248640	107	5656586	6274361	162
6677412	6183077	58	6362479	6192041	51	6492916	6193366	60	6313938	6248667	111	5656616	6274362	162
6677474	6183085	59	6800056	6192068	53	5042518	6193387	61	5691013	6248694	115	5656623	6274366	162
6677391	6183212	24	6362233	6192076	55	5042587	6193391	62				5656630	6274370	163
6677345	6183255	29	6795079	6192084	57	5042655	6193395	63	6652570	6248993	93	5656647	6274371	163
6677351														

GTIN	Item no.	Page	GTIN	Item no.	Page	GTIN	Item no.	Page
	/pc.			price/pac			/pc.	
5656791	6274510	165	5660590	6277290	183	5915003	6288579	280
5656807	6274511	165	5700852	6277294	193	5889083	6288583	280
5656814	6274512	165		price/m		6789146	6288608	280
5656821	6274516	165	5660606	6277300	188		/pc.	
5656838	6274520	166		/pc.		5148678	6288610	160
5656845	6274521	166	5661023	6277370	190	5148777	6288640	163
5656852	6274522	166		price/m		5149088	6288700	184
5656869	6274526	166	5661139	6277400	192	5149101	6288704	148
5656876	6274540	166	5661740	6277500	193	5149460	6288790	160
5656883	6274541	166	5662174	6277600	197	5160663	6288930	253
5656890	6274542	166		/pc.		5160670	6288933	253
5656906	6274546	166	5662464	6277670	199	5160731	6288940	258
5656913	6274560	166		/pc.		5160908	6288963	260
5656920	6274561	166		price/m				
5656937	6274562	166	5664666	6278200	204	6770472	6289405	271
5656944	6274566	166	5665557	6278400	210		/pc.	
5656951	6274570	167	5666400	6278680	161	5773863	6289970	267
5656968	6274571	167	5666417	6278681	161	5773870	6289972	267
5656975	6274572	167	5666424	6278682	161	5773887	6289974	269
5656982	6274576	167	5666486	6278686	161	5773924	6289976	269
5846901	6274610	169				5811787	6289980	278
5846918	6274611	169	5842552	6279100	225	5811794	6289982	278
5846925	6274612	169	5842545	6279103	225			
5847052	6274620	170	5768050	6279200	217	5161202	6290010	255
5847069	6274621	170	5768067	6279203	217	5161219	6290013	255
5847076	6274622	170		/pc.		5161226	6290020	273
5846963	6274640	170	5768302	6279270	218	5161264	6290023	273
5847007	6274641	170	5768340	6279273	218	5161288	6290030	274
5847014	6274642	170		price/m		5161325	6290033	274
	price/m		5768364	6279300	220	5161349	6290040	275
5657040	6274700	168	5768401	6279303	220	5161387	6290043	275
5657057	6274701	168		/pc.		5161561	6290073	276
5657064	6274702	168	5768654	6279370	222	5428091	6290086	262
5657071	6274706	168	5768661	6279373	222	5428107	6290087	262
	/pc.			price/m		5428138	6290090	277
5657101	6274710	169	5768715	6279400	228	5428145	6290091	277
5657118	6274711	169	5768722	6279403	228	5459095	6290095	264
5657125	6274712	169		/pc.		5459101	6290097	264
5657132	6274716	169	5769002	6279470	226	5161691	6290120	254
5657149	6274720	170	5818885	6279473	226	5161707	6290124	254
5657156	6274721	170		price/m		5161813	6290150	256
5657163	6274722	170	5769064	6279500	231	5161868	6290160	254
5657170	6274726	170	5769071	6279503	231	5161936	6290174	254
5657187	6274740	170		/pc.		5428152	6290178	263
5657194	6274741	170	5769361	6279570	231	5459231	6290196	265
5657200	6274742	170	5769378	6279573	231	5459248	6290197	265
5657217	6274746	170		price/m		5459279	6290198	265
5657224	6274760	171	5769491	6279600	232	5162063	6290200	254
5657231	6274761	171	5769507	6279603	232	5418566	6290260	257
5657248	6274762	171		/pc.		5428169	6290264	263
5657255	6274766	171	5769804	6279670	233	5448792	6290269	265
5657262	6274770	171	5769798	6279673	233	5817055	6290372	268
5657279	6274771	171		price/pac		5817062	6290382	270
5657286	6274772	171	5769989	6279701	217	5817079	6290387	268
5657293	6274776	171	5770022	6279704	221			
5657309	6274790	161		price/m				
5657347	6274791	161	5770039	6279711	219			
5657354	6274792	161	5770046	6279714	223			
5657361	6274796	161	5770084	6279720	218			
5657408	6274810	244	5770091	6279723	218			
5657477	6274820	244		/pc.				
	price/m		5680680	6279800	242			
5658122	6274900	163	5680734	6279806	242			
				price/m				
5897071	6276900	221	5695813	6279850	184			
5897064	6276903	221	5695868	6279852	184			
	/pc.							
5897224	6276970	222		/pc.				
5897187	6276973	222	5143888	6286700	272			
			5143918	6286702	272			
	price/m		5144090	6286810	272			
5658726	6277000	183						
5658740	6277002	183		price/m				
5658788	6277003	183	5146575	6287700	242			
	/pc.			/pc.				
5659044	6277040	185	5146797	6287810	243			
	price/m							
5659334	6277090	185	5676140	6288001	242			
5659341	6277095	186	5676188	6288003	242			
5660002	6277200	187	5676195	6288005	242			
5660057	6277202	187	5676201	6288007	242			
	/pc.		5147152	6288100	242			
5660484	6277270	190	5914990	6288569	280			

Gebäude Bałtikum 3 / en / 2022/04/07 11:41:01 (LLExpof_02988) / 2022/04/07 11:41:21 11:41:21



OBO Bettermann OÜ
Läike tee 20
75312 Rae vald
Estonia
Tel.: +372 6519870
E.mail: obo@obo.ee
Web: www.obo.ee

OBO Bettermann SIA
Piedrujas iela 7c
LV-1073 Riga
Latvia
Tel.: +371 67802050
E.mail: obo@obo.lv
Web: www.obo.lv

OBO Bettermann UAB
Jankiškių g. 52
02300 Vilnius
Lithuania
Tel.: +370 52375912
E.mail: obo@obo.lt
Web: www.obo.lt

Building Connections

