

# Technical data sheet

## Spacer sleeve for insulated ceilings

Item number: 7205908



The spacer sleeves for mounting suspension brackets under insulated ceilings prevent the insulation from denting when the fastening screws are tightened.

Burr-free, galvanised internally and externally.

- St** Steel
- FT** Hot-dip galvanised

### Master data

Item number	7205908
Type	DHI 130
Description 1	Spacer sleeve
Description 2	for insulated ceilings
Manufacturer	OBO
Dimension	33,7x130x3mm
Material	Steel
Surface	Hot-dip galvanised
Surface standard	DIN EN ISO 1461
Smallest sales unit	12
Unit of quantity	Piece
Weight	30.4 kg
Weight unit	kg/100 pc.

# Technical data sheet

## Spacer sleeve for insulated ceilings

Item number: 7205908



### Dimensions

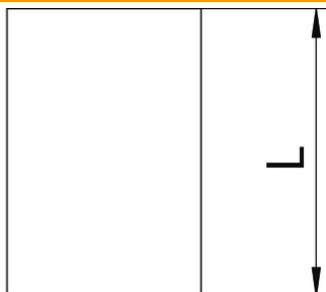

Length	130 mm
Dimension L	130 mm

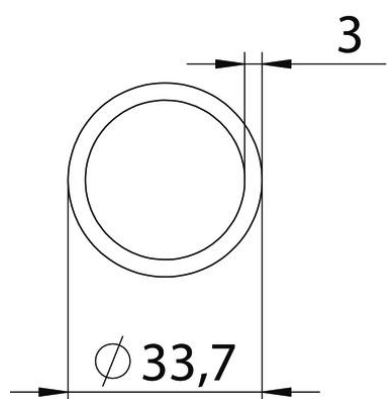

### Technical data

Inner diameter	27.7 mm
----------------	---------