

Technical data sheet

DSSL heavy-duty support

Item number: 7410587



The heavy-duty supports reinforce the corner areas of the type UZD-3 underfloor box for increased load requirements.

The VPE consists of four heavy-duty supports.



St Steel

FS Strip galvanized

Master data

Item number	7410587
Description 1	Heavy-duty support
Description 2	for underfloor socket
Manufacturer	OBO
Dimension	165/200
Material	Steel
Surface	Strip galvanized
Surface standard	DIN EN 10346
Smallest sales unit	1
Unit of quantity	Packaging unit
Weight	132.64 kg
Weight unit	kg/100 PUs

Technical data sheet

DSSL heavy-duty support

Item number: 7410587



Dimensions

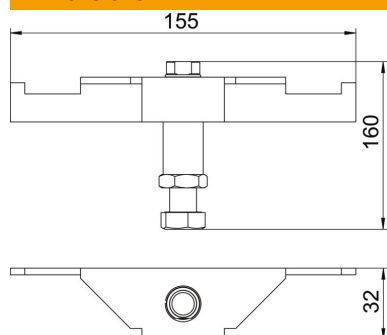

Length	155 mm
Width	32 mm
Height	160 mm

Technical data

Type of accessory	Support
Screed height, max.	200 mm
Screed height, min.	165 mm
Heavy-duty version	yes